

# 18th Century Material Culture Textile Production - Diderot

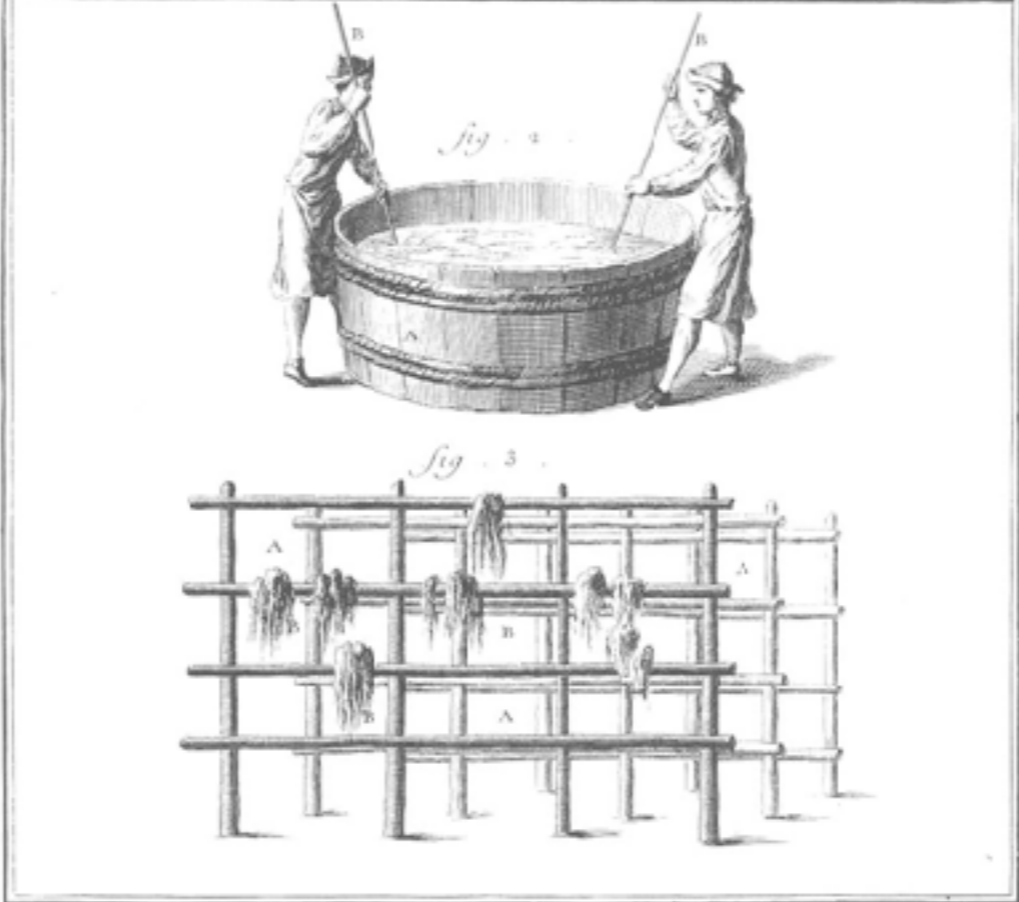

“Draperie”

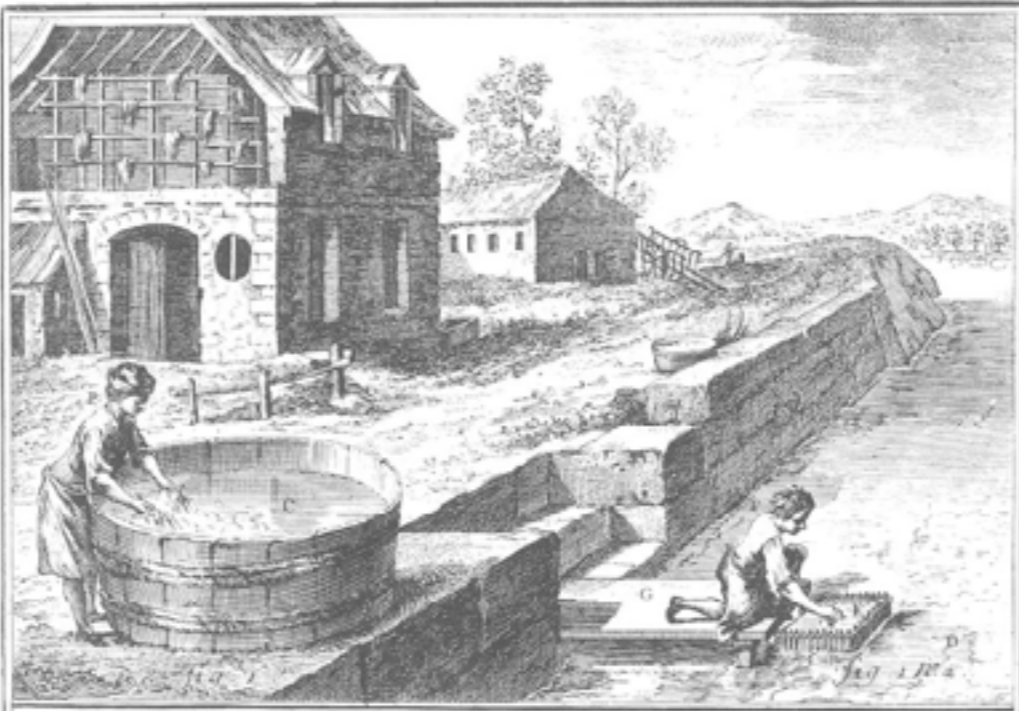

*Draperie.*

“Draperie.”  
 The Encyclopedia of Diderot & d'Alembert 1763  
 (University of Michigan)

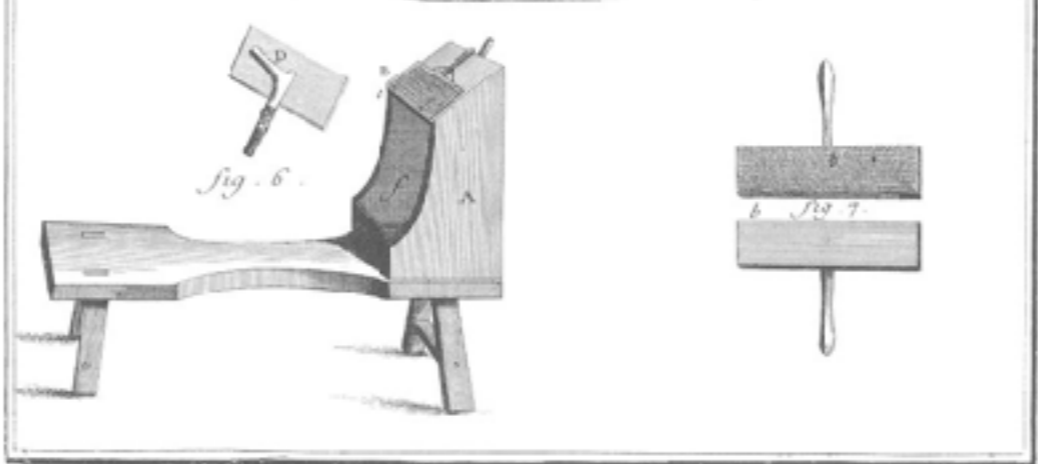
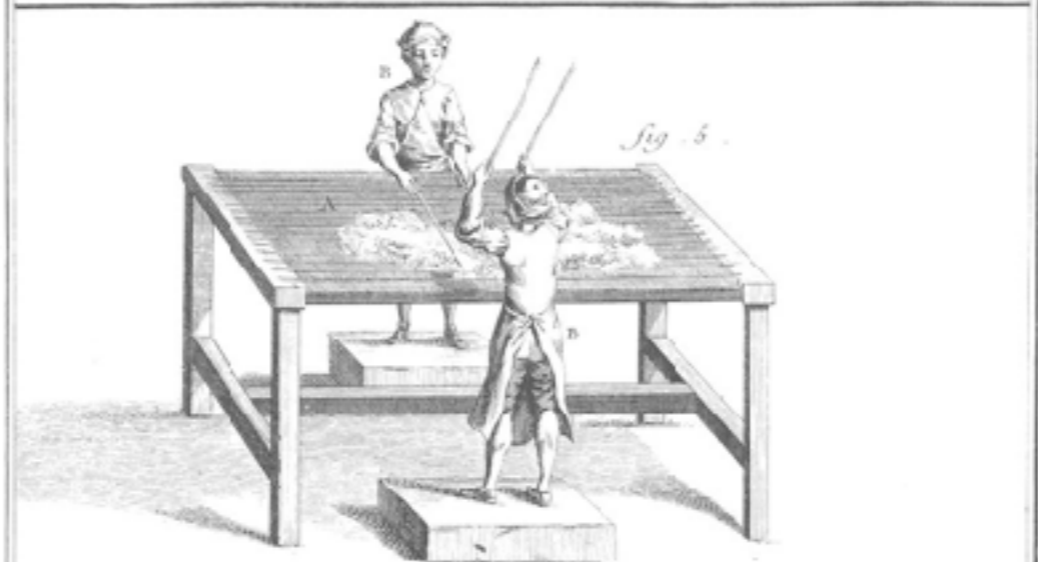
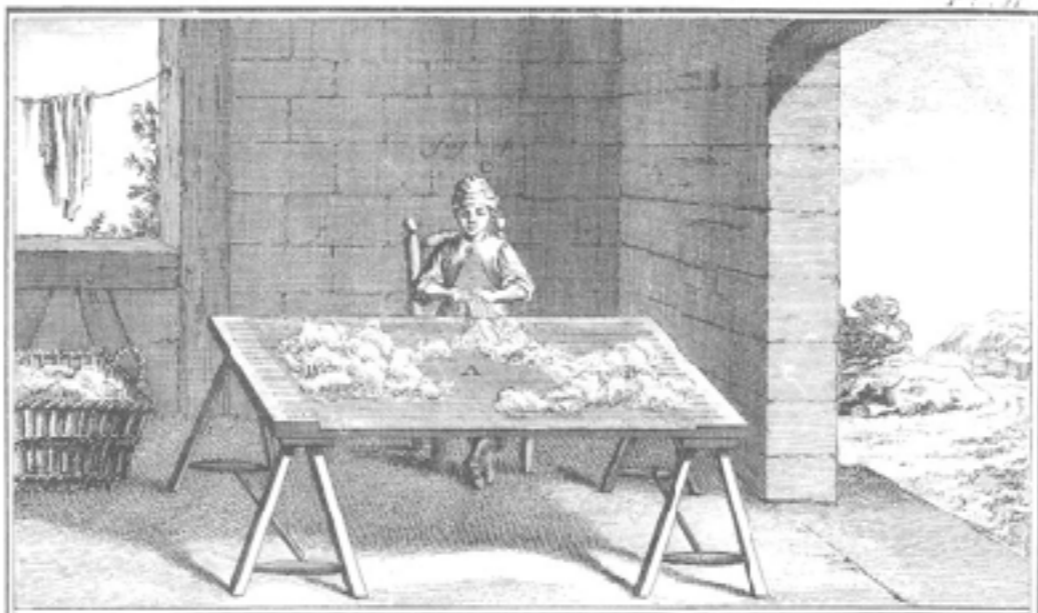

*Draperie.*

“Draperie.”  
The Encyclopedia of Diderot & d'Alembert 1763  
(University of Michigan)

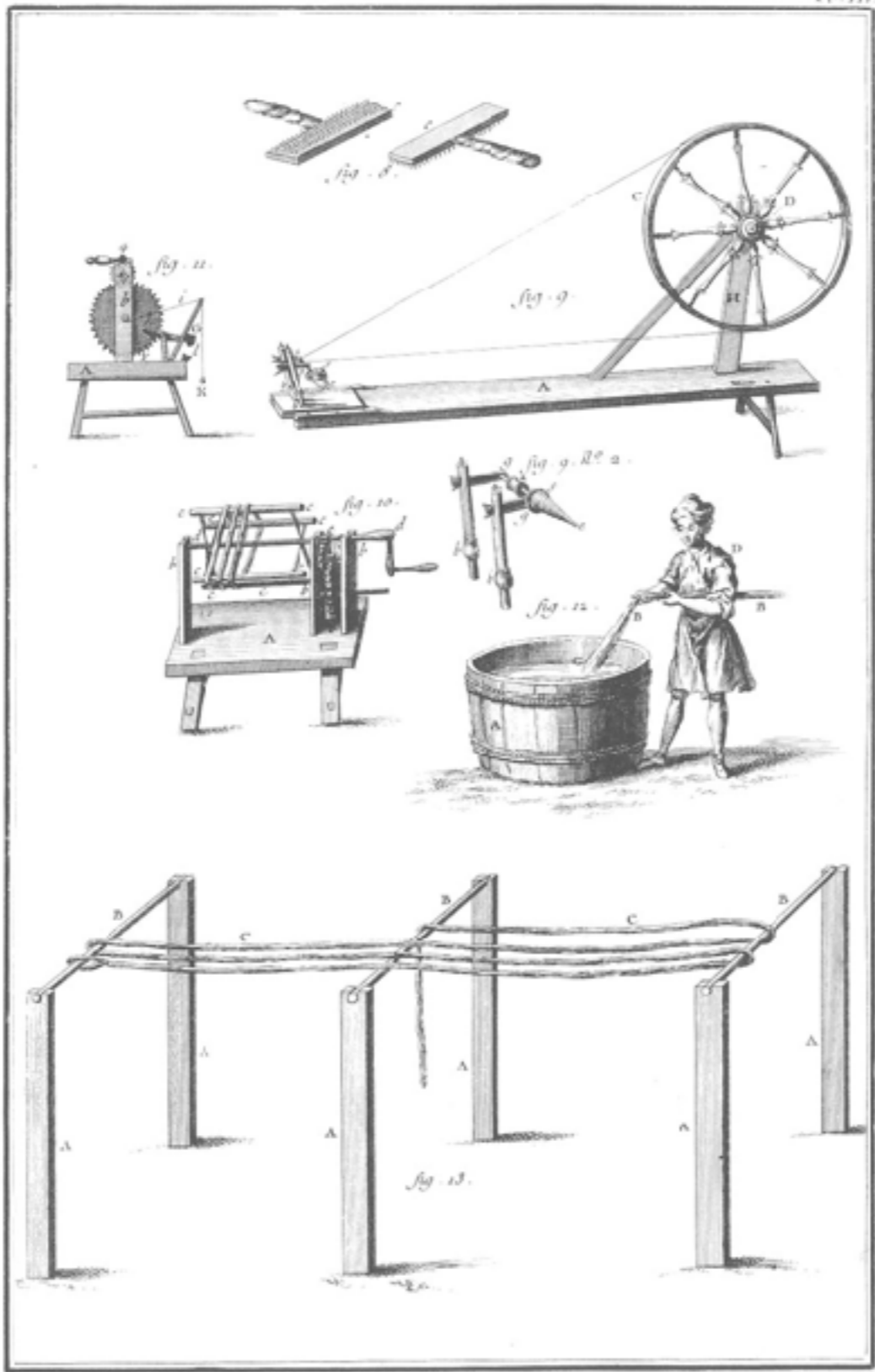

Benard del.

Fouquet fecit.

*Draperie.*

“Draperie.”  
 The Encyclopedia of Diderot & d'Alembert 1763  
 (University of Michigan)

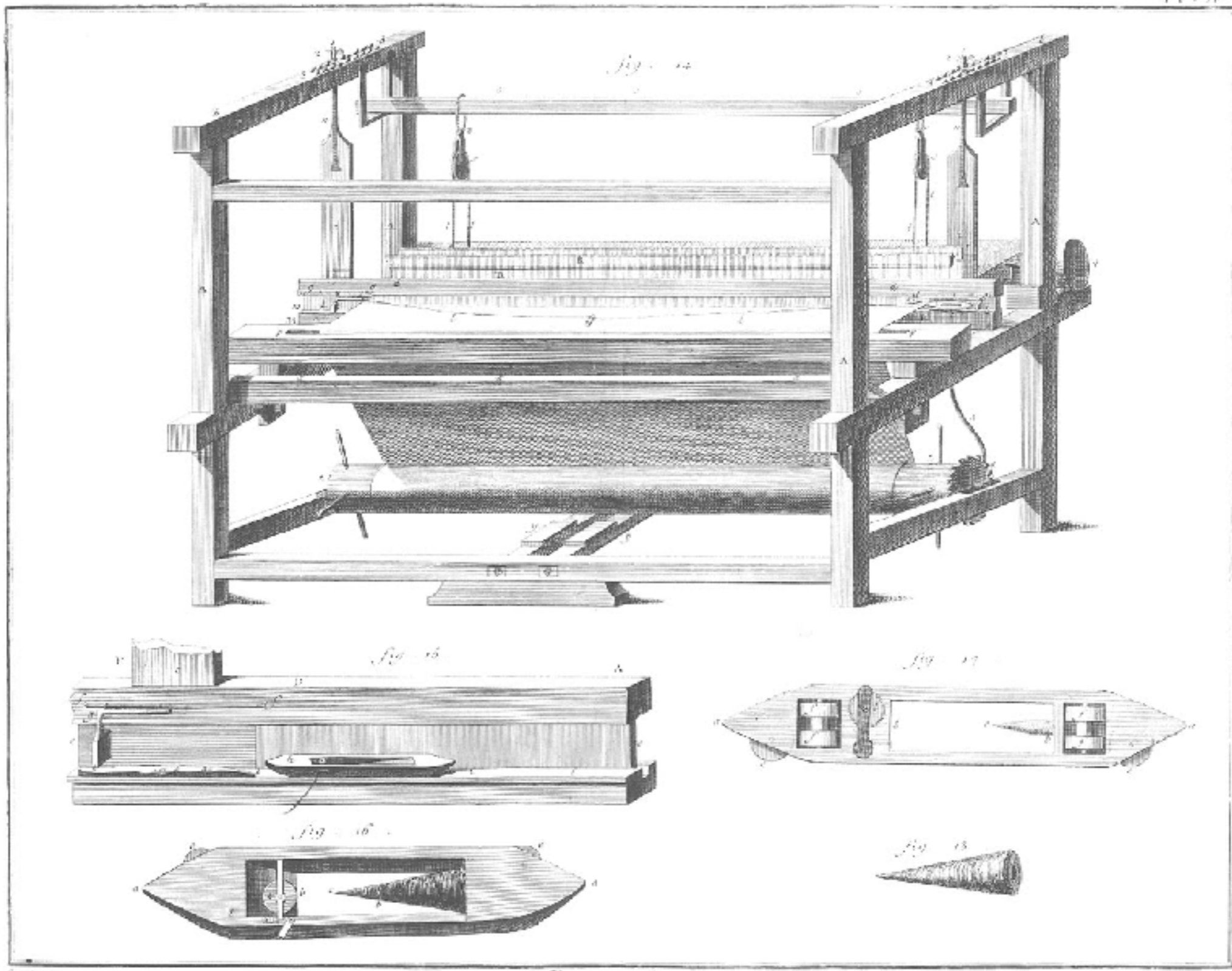

*Draperie.*

“Draperie.”  
 The Encyclopedia of Diderot & d'Alembert 1763  
 (University of Michigan)

fig. 19.

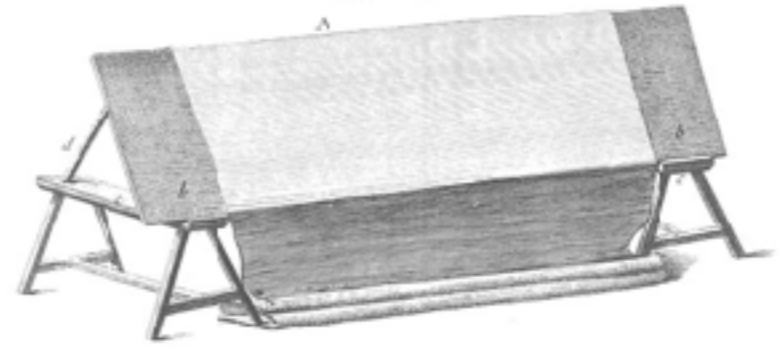
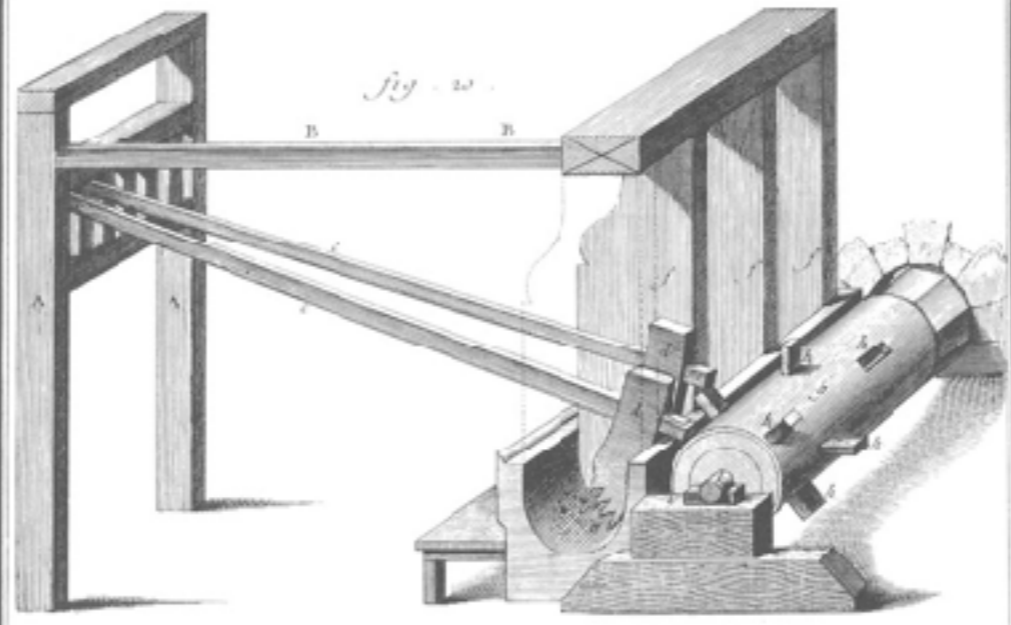

fig. 20.



Draperie.

“Draperie.”  
 The Encyclopedia of Diderot & d'Alembert 1763  
 (University of Michigan)

fig. 2

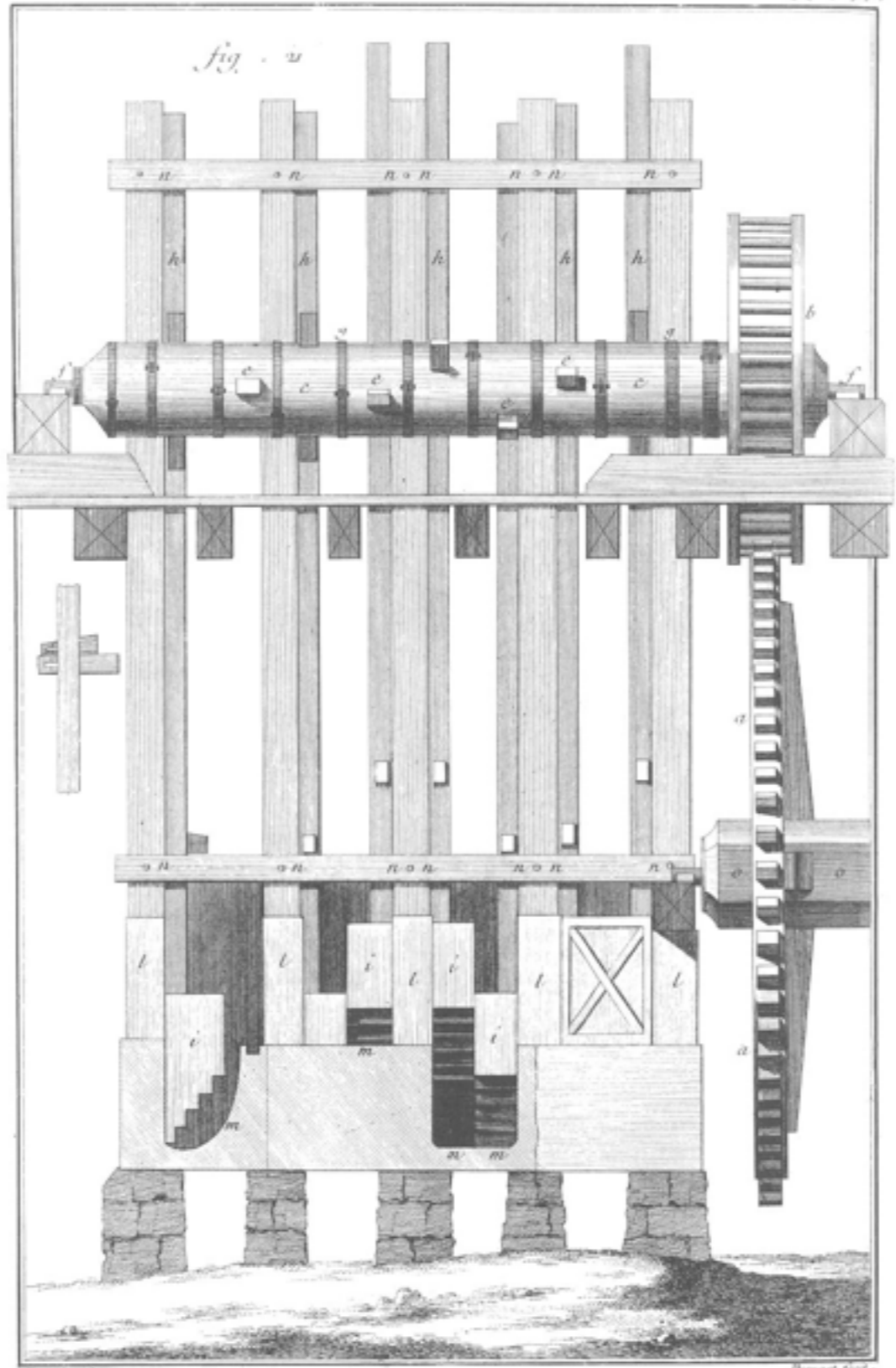

Draperie.

“Draperie.”  
 The Encyclopedia of Diderot & d'Alembert 1763  
 (University of Michigan)

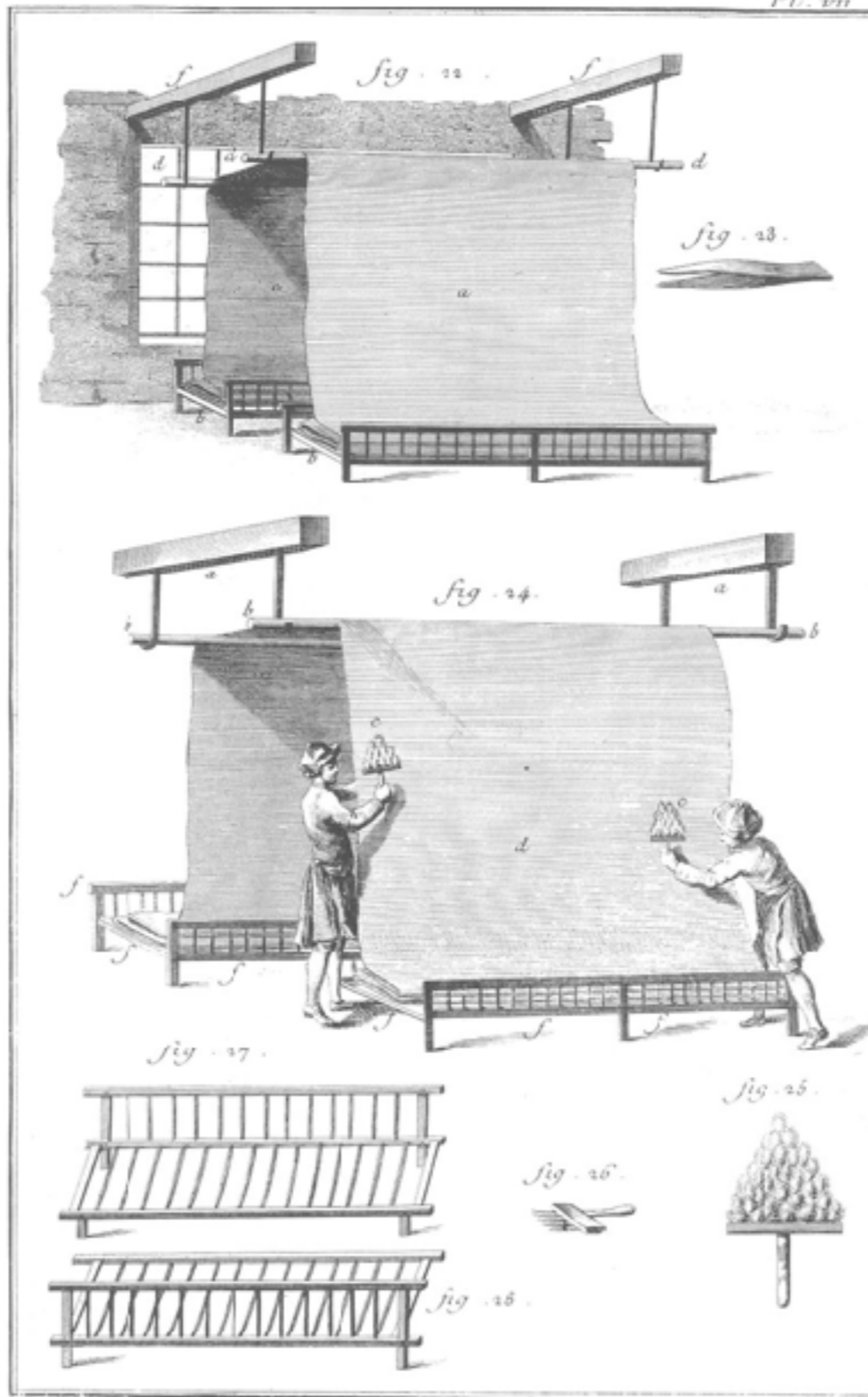

*Draperie.*

“Draperie.”  
 The Encyclopedia of Diderot & d'Alembert 1763  
 (University of Michigan)

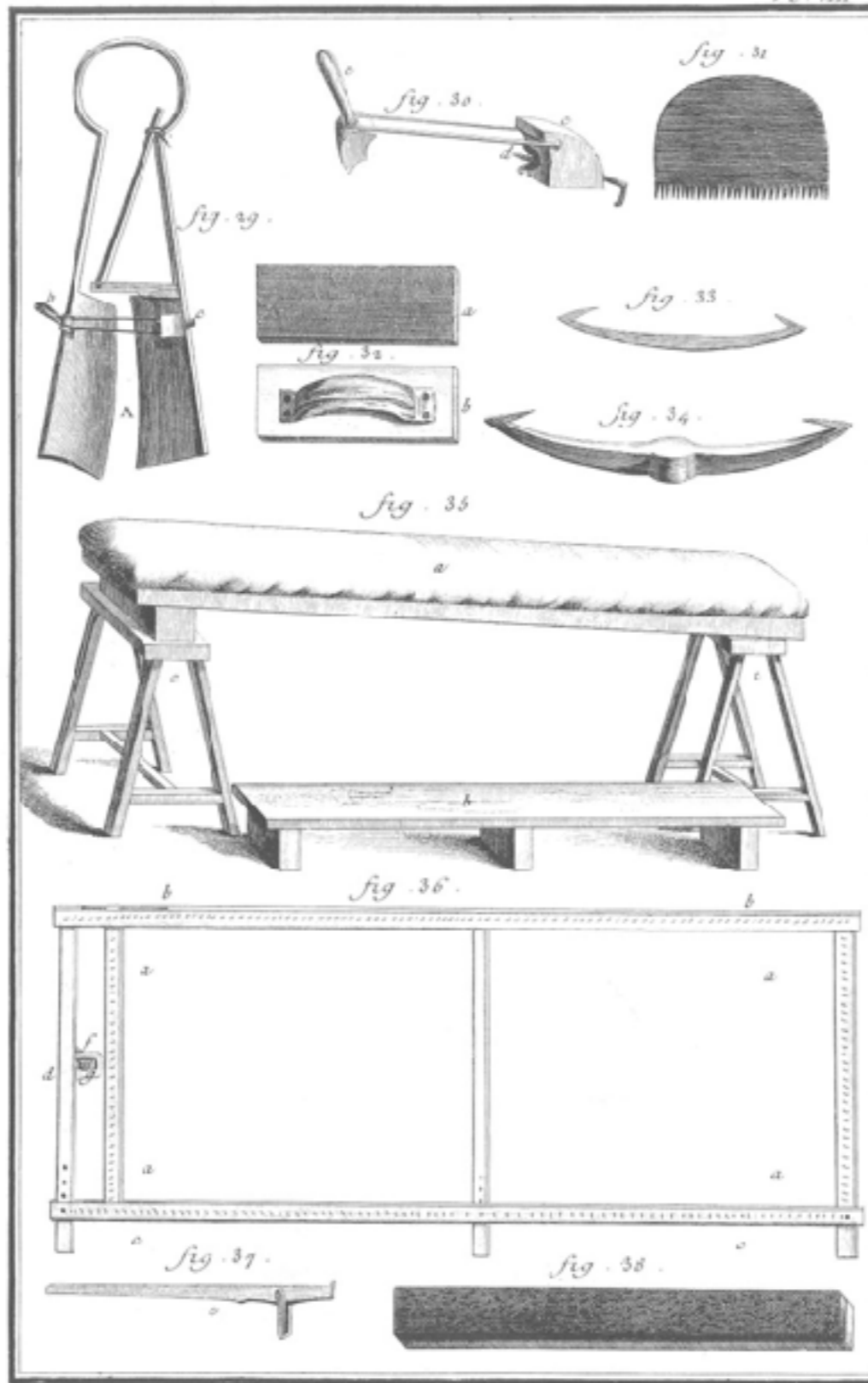

Gravé par

Perrot, fecit

*Draperie.*

“Draperie.”

The Encyclopedia of Diderot & d'Alembert 1763  
(University of Michigan)

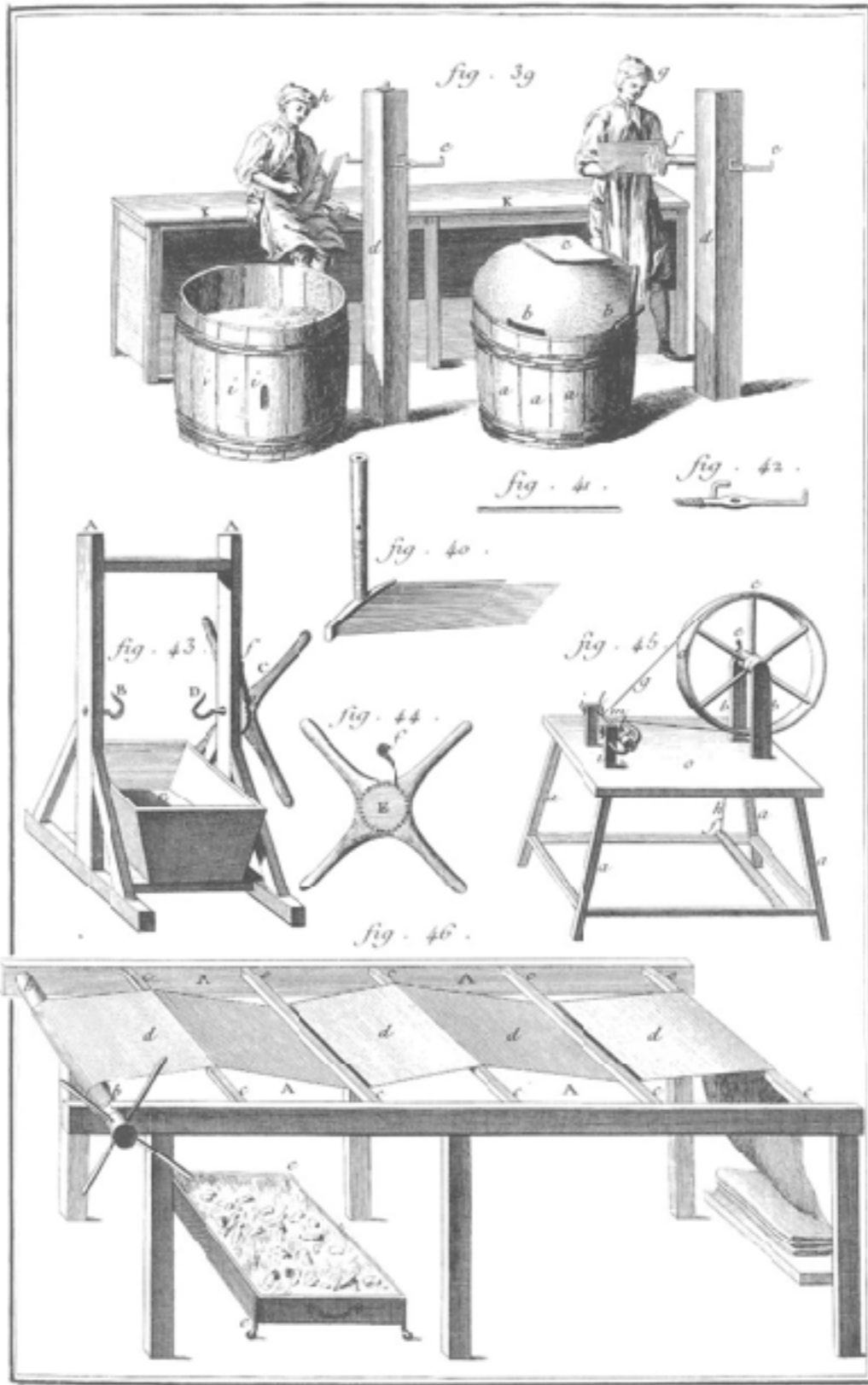

*Draperie.*

“Draperie.”

The Encyclopedia of Diderot & d'Alembert 1763  
(University of Michigan)

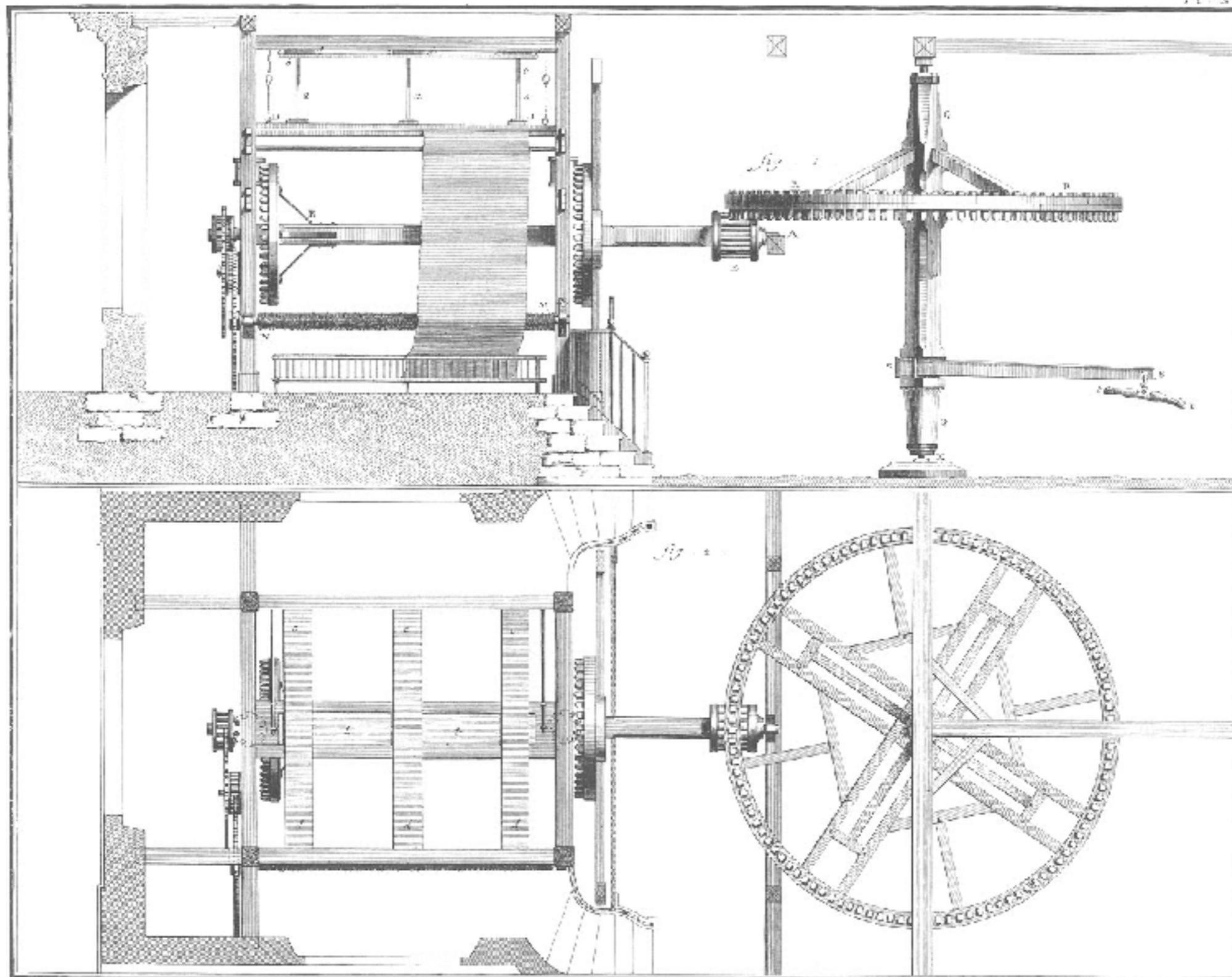

*Draperie.*

“Draperie.”  
The Encyclopedia of Diderot & d'Alembert 1763  
(University of Michigan)

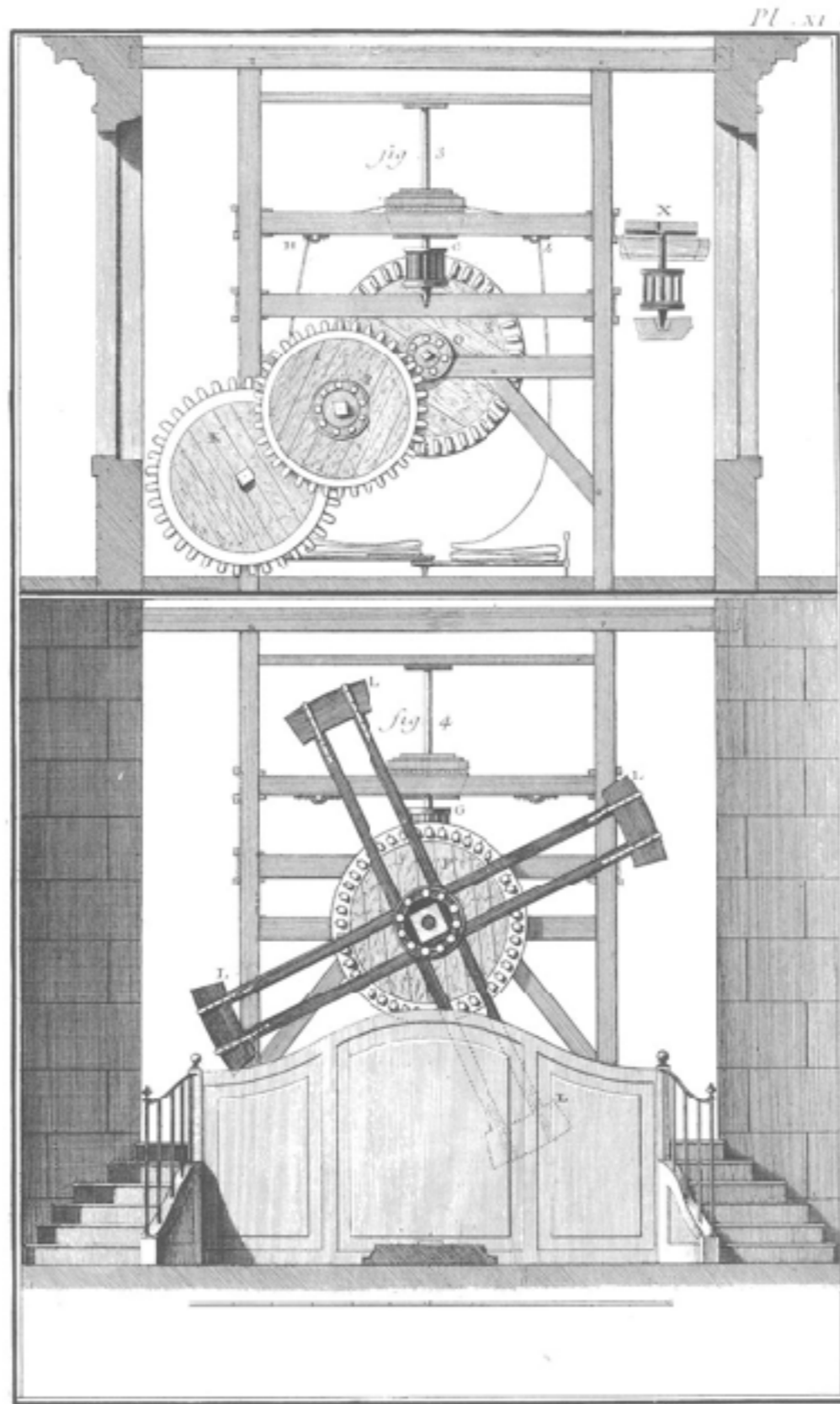

*Draperie.*

“Draperie.”  
The Encyclopedia of Diderot & d'Alembert 1763  
(University of Michigan)

# Hemp Production

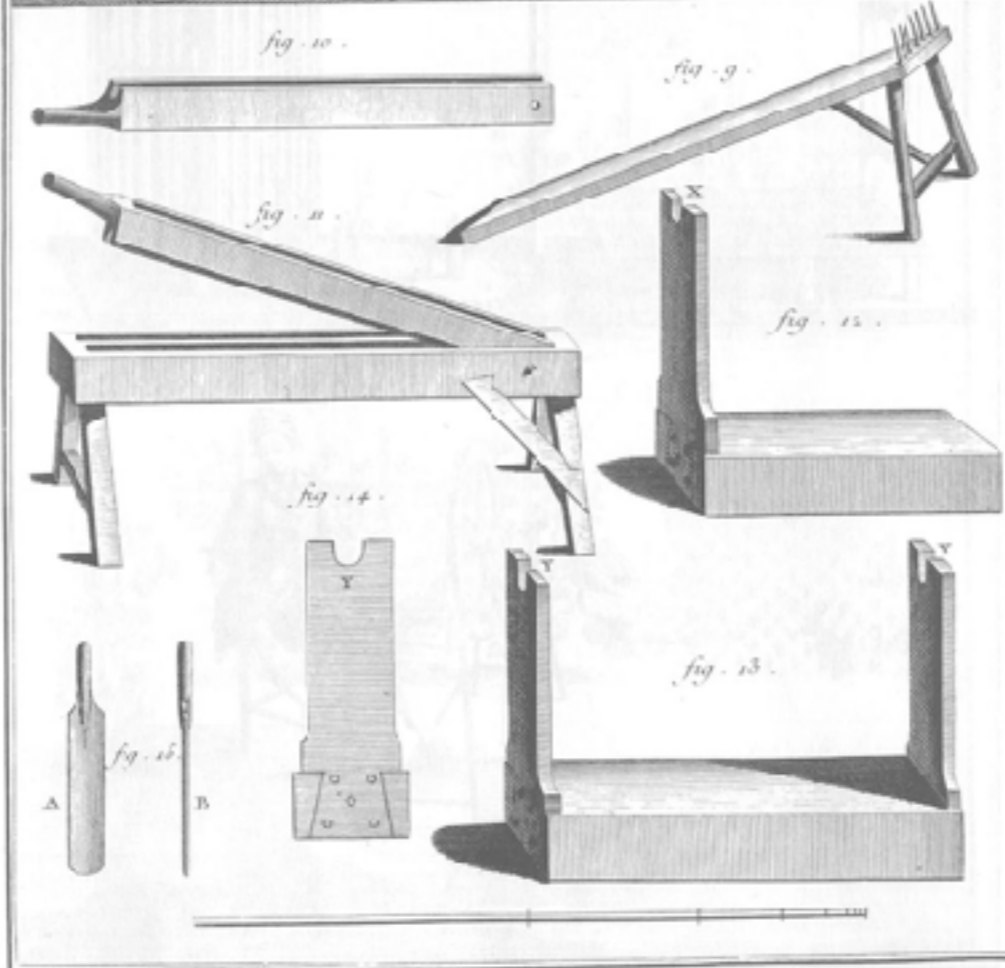
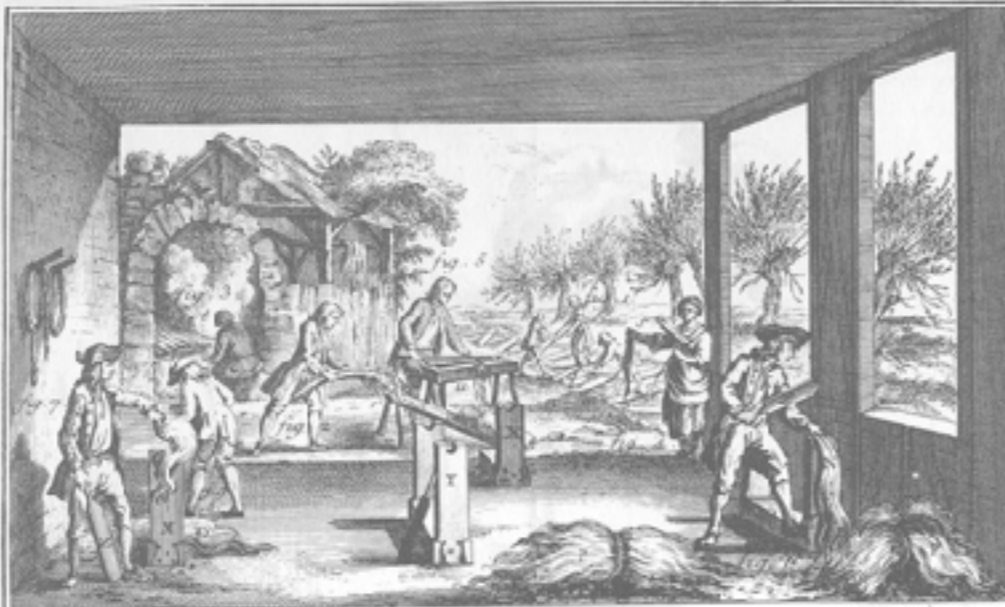

*OEconomie Rustique,  
Culture et Travail du Charreux.*

“OEconomie Rusique,...”  
The Encyclopedia of Diderot & d'Alembert 1763  
(University of Michigan)

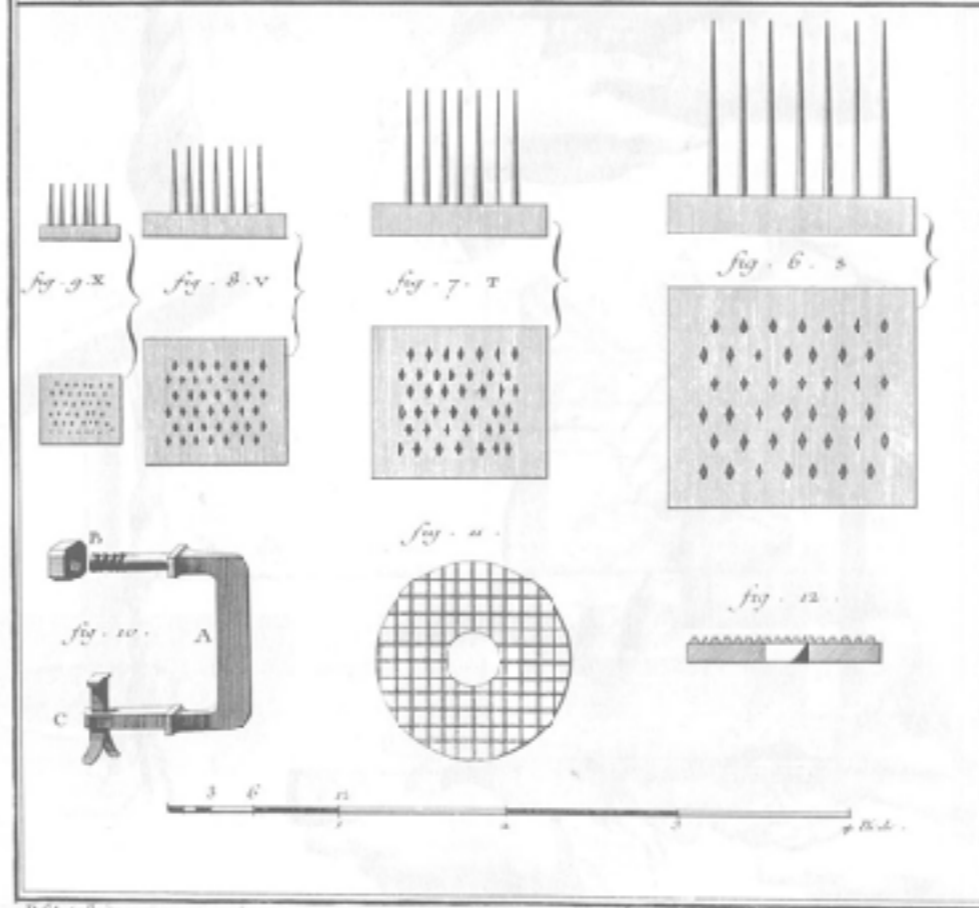

*D'États*  
*OÉconomie Rustique,*  
*Culture et Travail du Chanvre.*

“OÉconomie Rusique,...”  
The Encyclopedia of Diderot & d'Alembert 1763  
(University of Michigan)

# Cotton Production

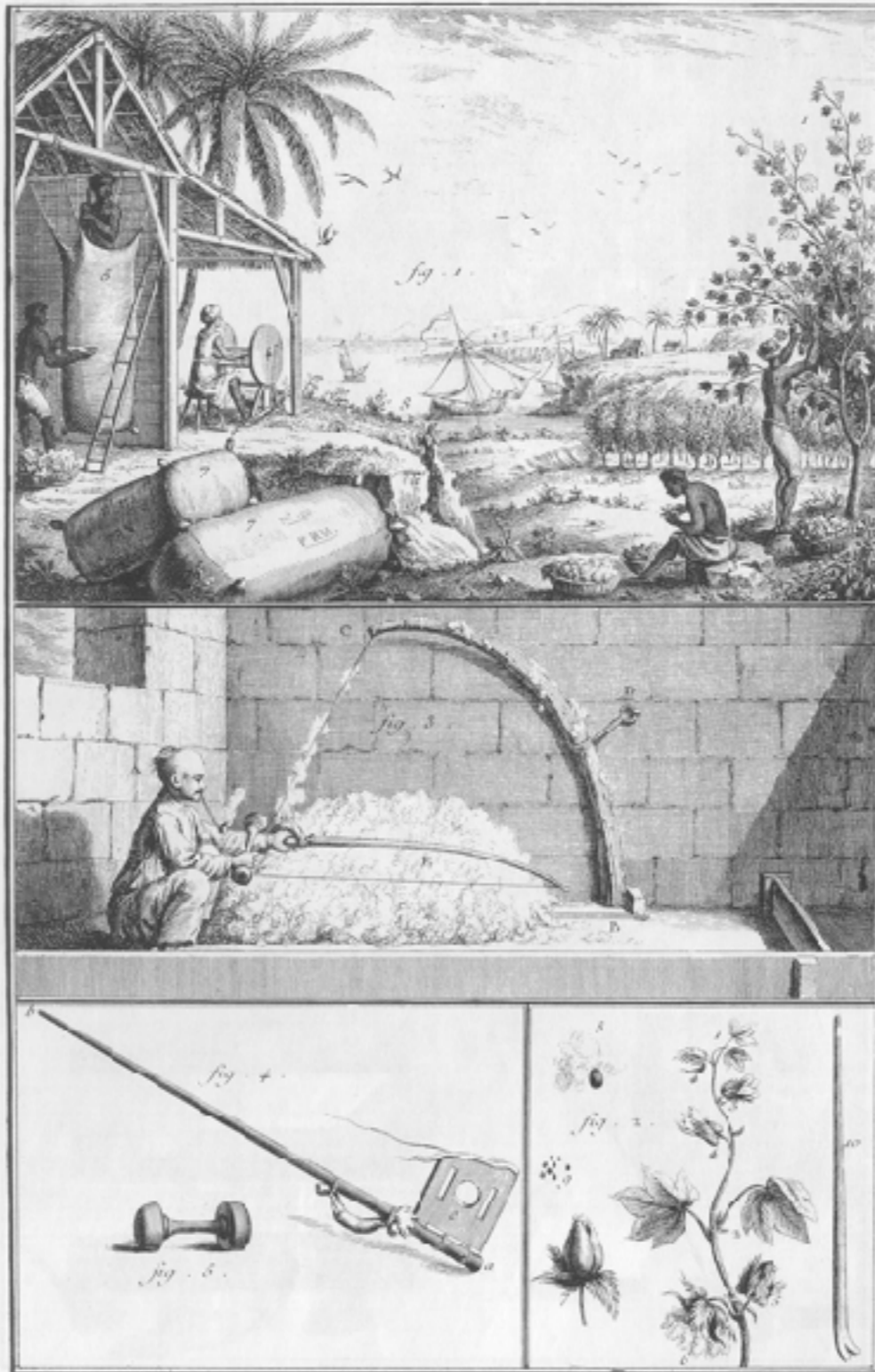

*Oeconomie Rustique,  
Culture et Arsonnage du Colton.*

“Oeconomie Rusique,...”  
The Encyclopedia of Diderot & d'Alembert 1763  
(University of Michigan)

# Thread / Wool Yarn Production

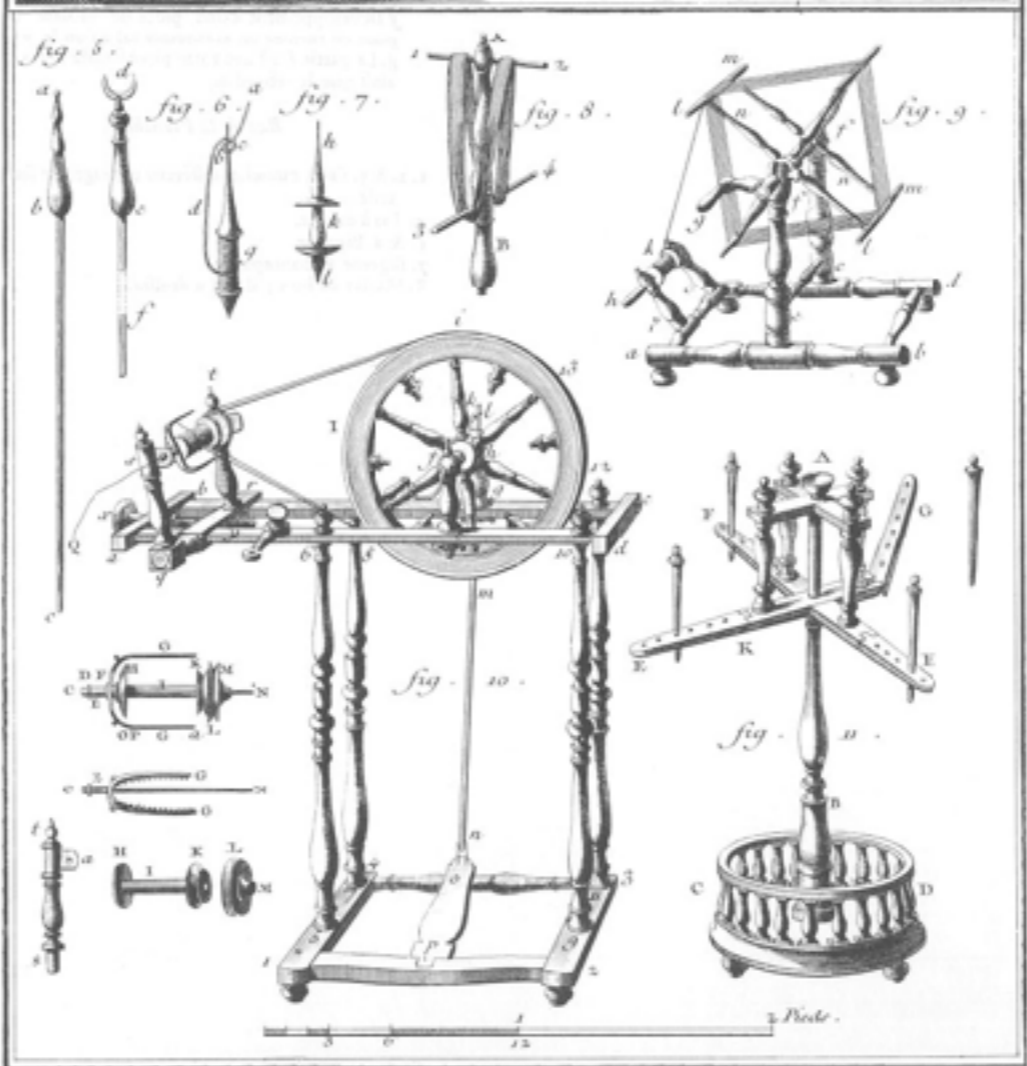
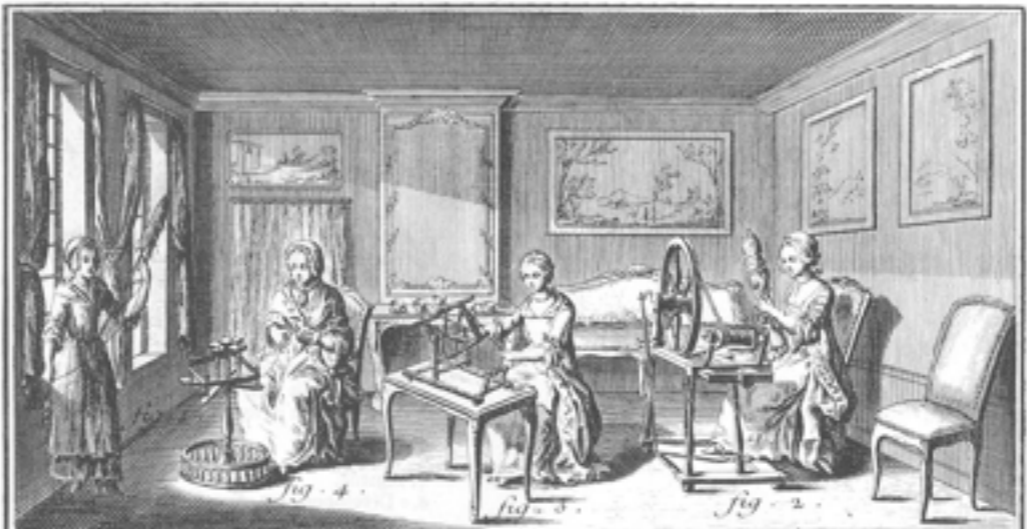

Fil, Rouet, Dévidoirs.

“Fil...”

The Encyclopedia of Diderot & d'Alembert 1763  
(University of Michigan)

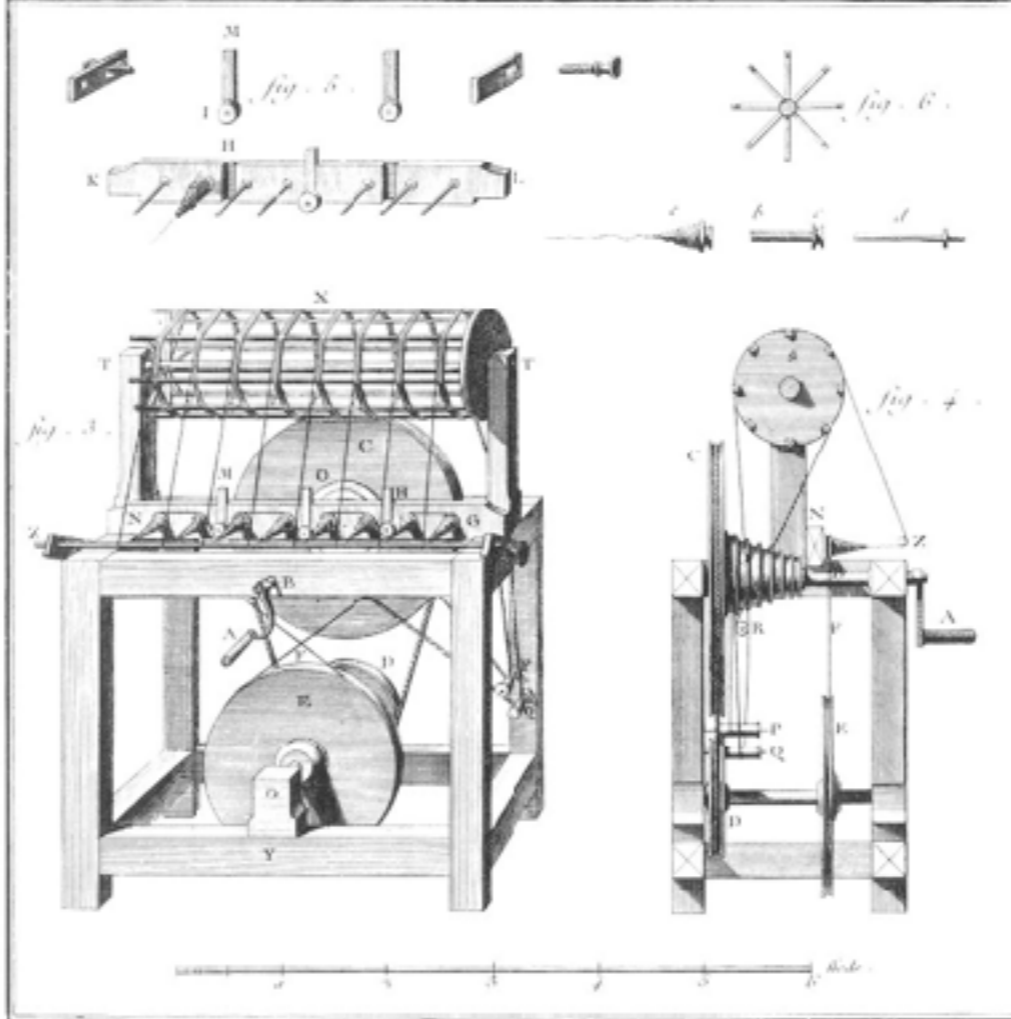
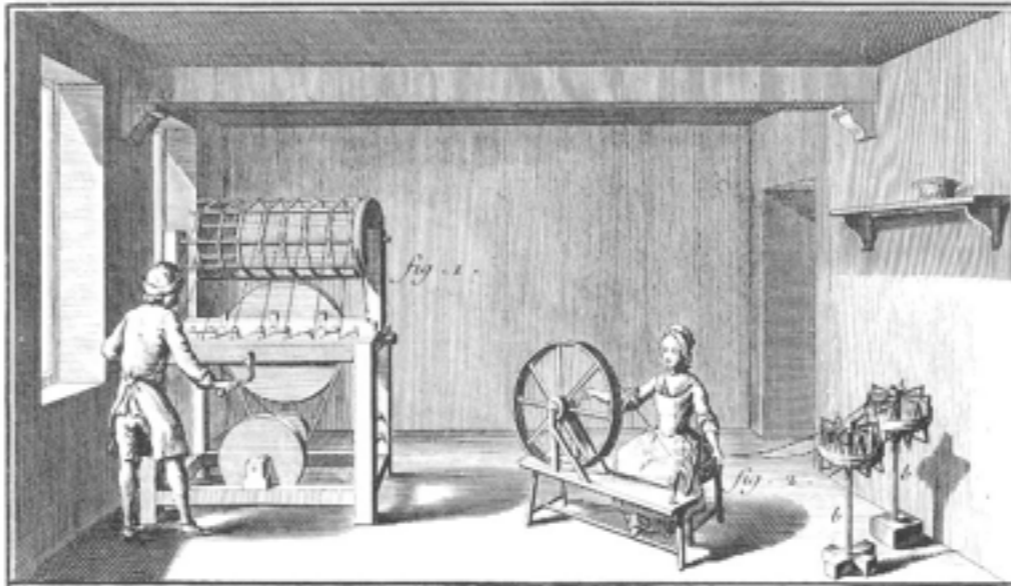

Fil, Rouet.

“Fil...”

The Encyclopedia of Diderot & d'Alembert 1763  
(University of Michigan)

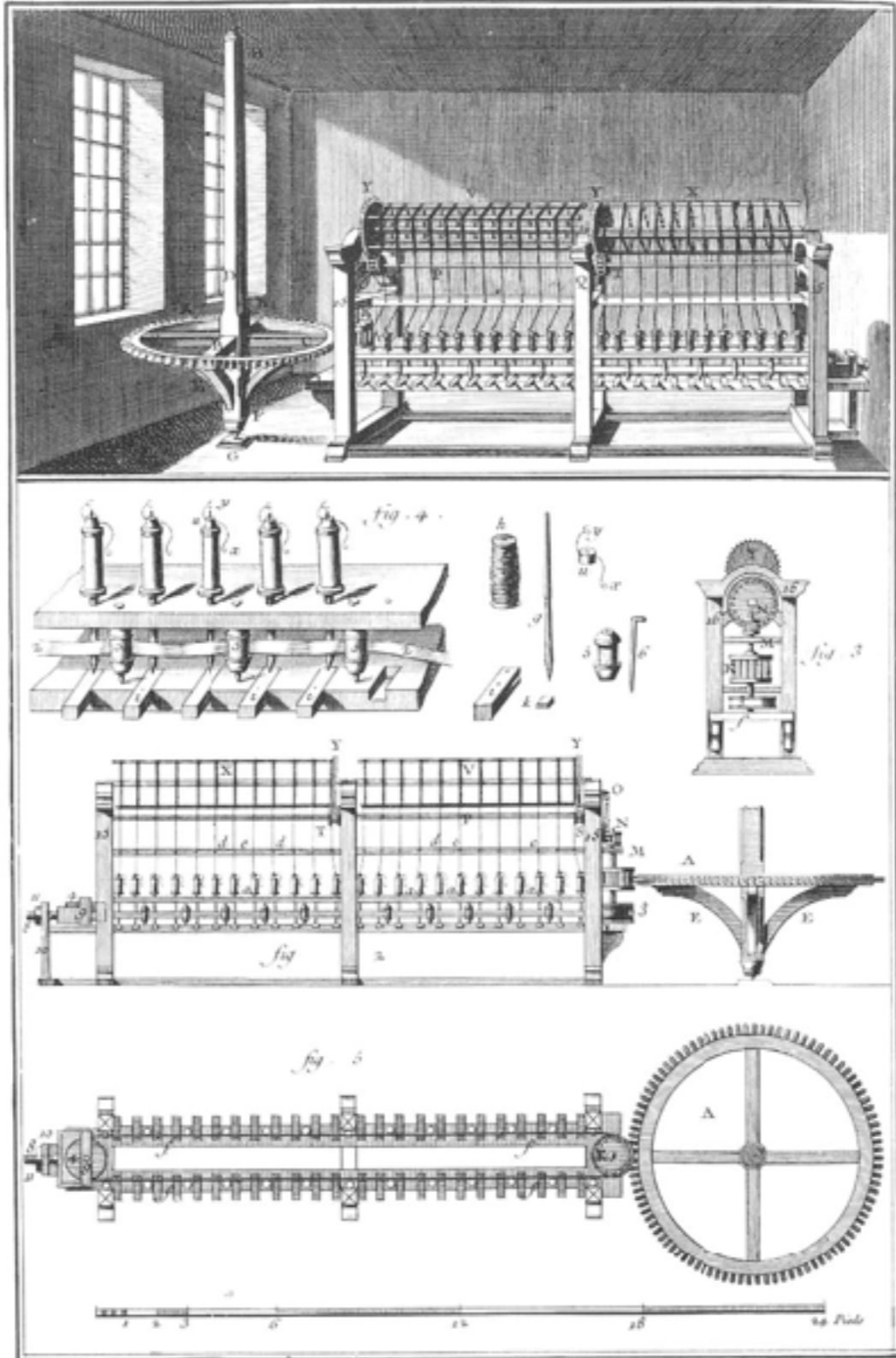

Fil, Moulin Quarré.

“Fil...”

The Encyclopedia of Diderot & d'Alembert 1763  
(University of Michigan)

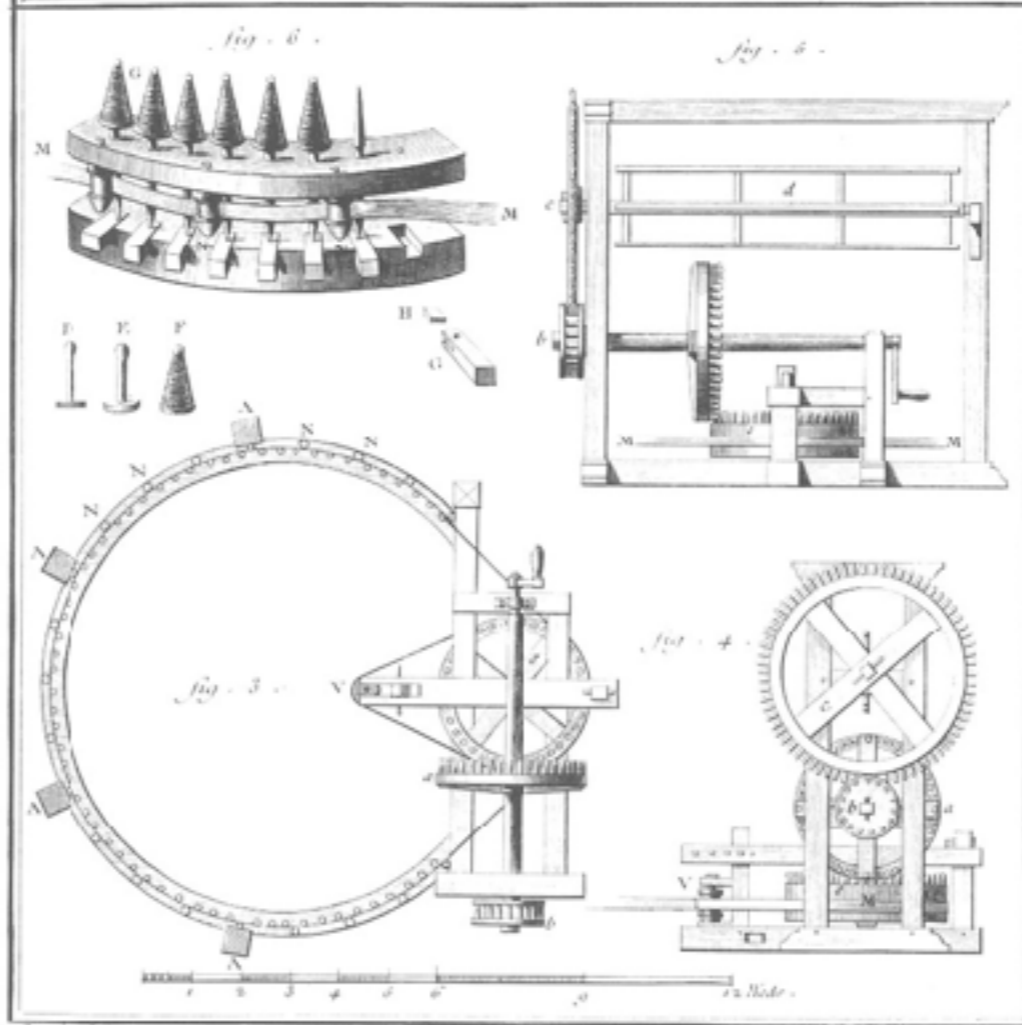
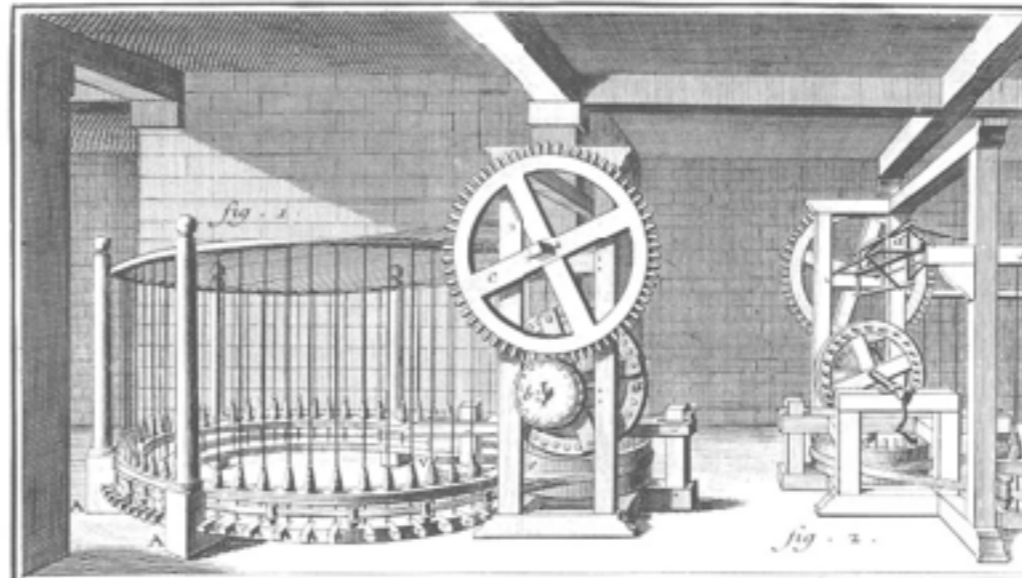

Benard del.

Fil, Moulin Rond.

“Fil...”

The Encyclopedia of Diderot & d'Alembert 1763  
(University of Michigan)

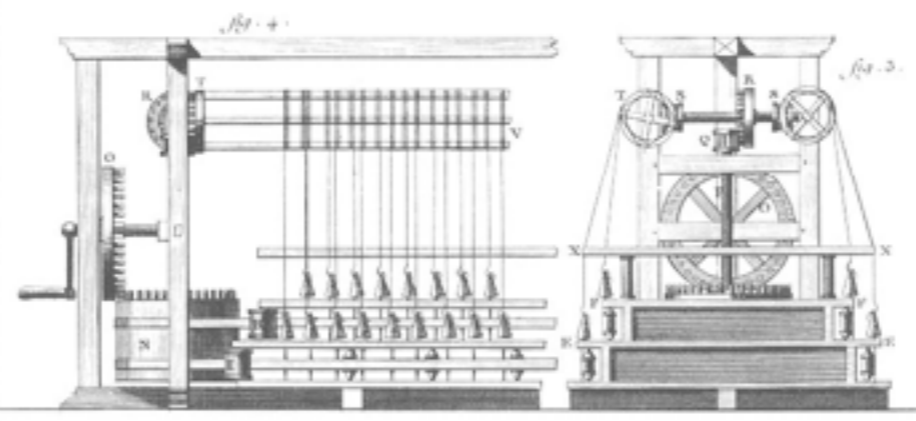
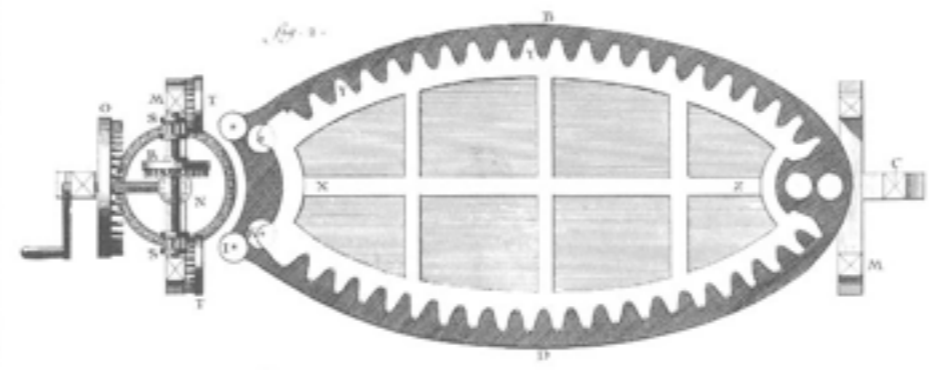
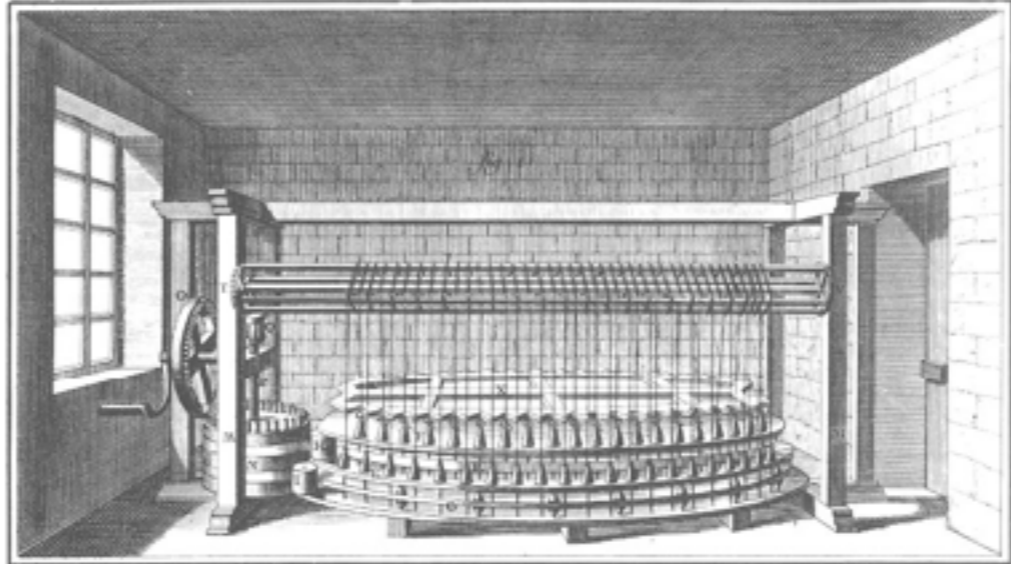

*Fil, Moutin Ovale.*

“Fil...”

The Encyclopedia of Diderot & d'Alembert 1763  
(University of Michigan)

# Marley Gauze Production

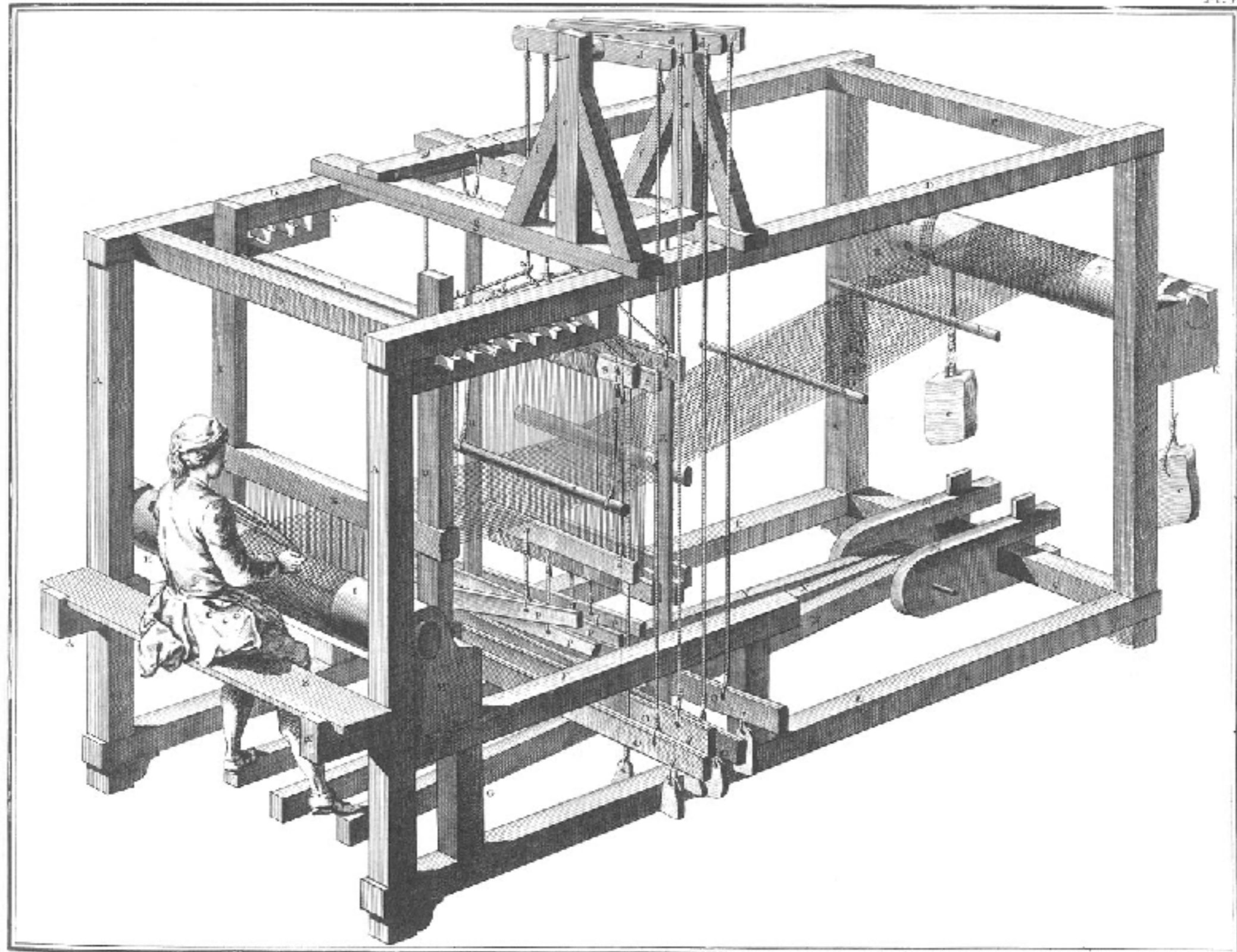

*Mètier à Marly.*

Loom for the Production of Marley Gauze  
 The Encyclopedia of Diderot & d'Alembert 1763  
 (University of Michigan)

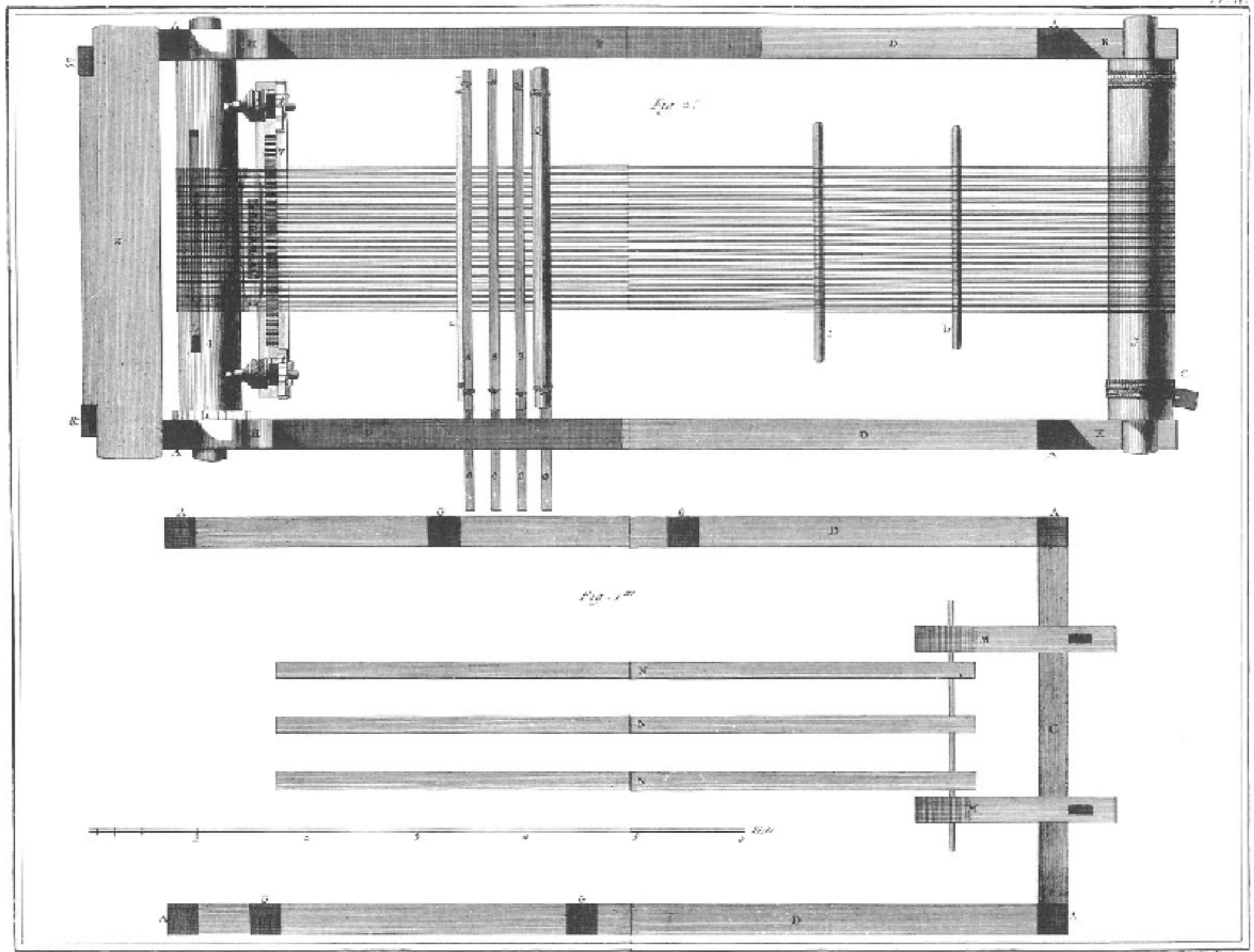

Plans du Métier à Marli.

Loom for the Production of Marley Gauze  
 The Encyclopedia of Diderot & d'Alembert 1763  
 (University of Michigan)

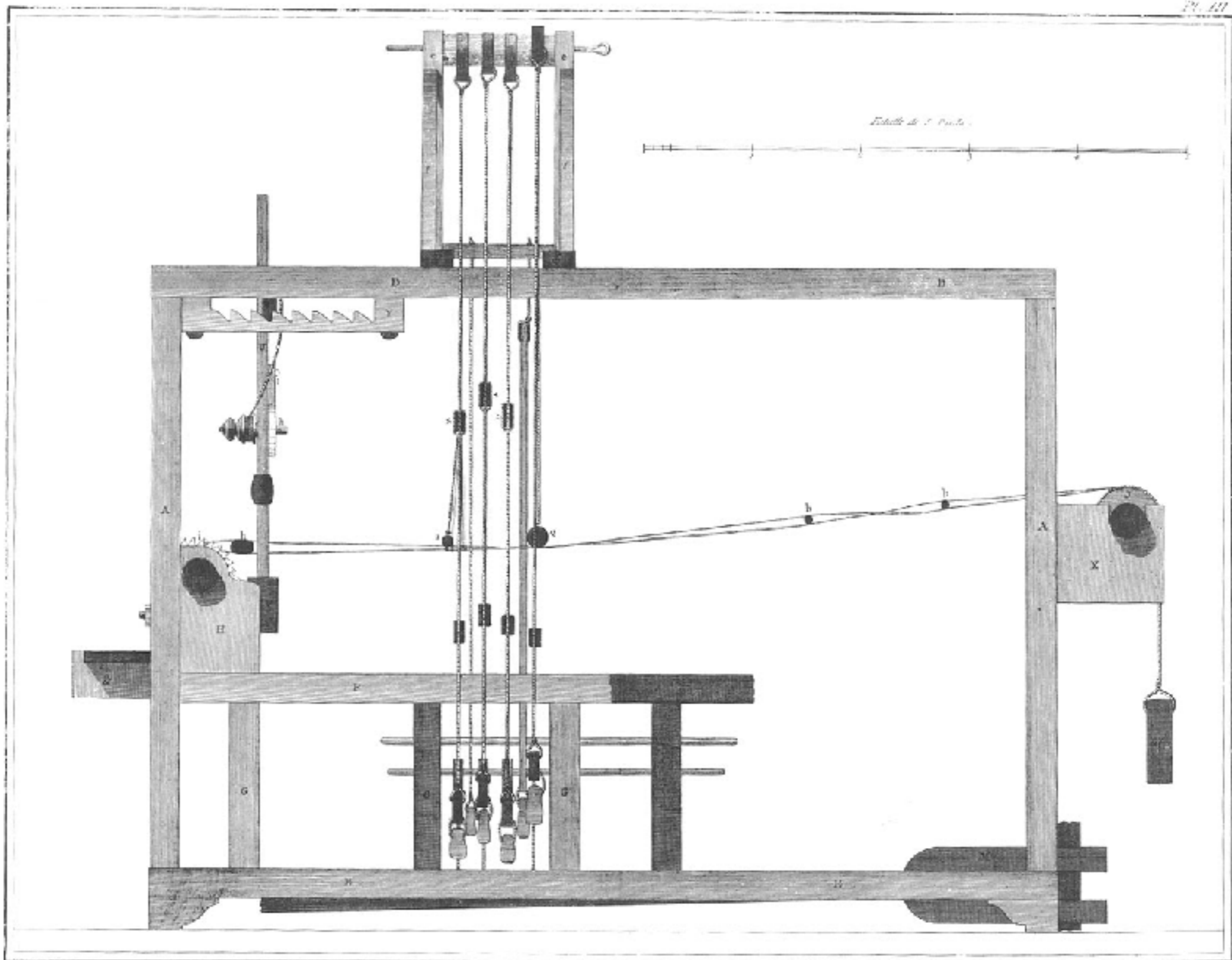

*Élévation Latérale du Métier à Marli.*

Loom for the Production of Marley Gauze  
 The Encyclopedia of Diderot & d'Alembert 1763  
 (University of Michigan)

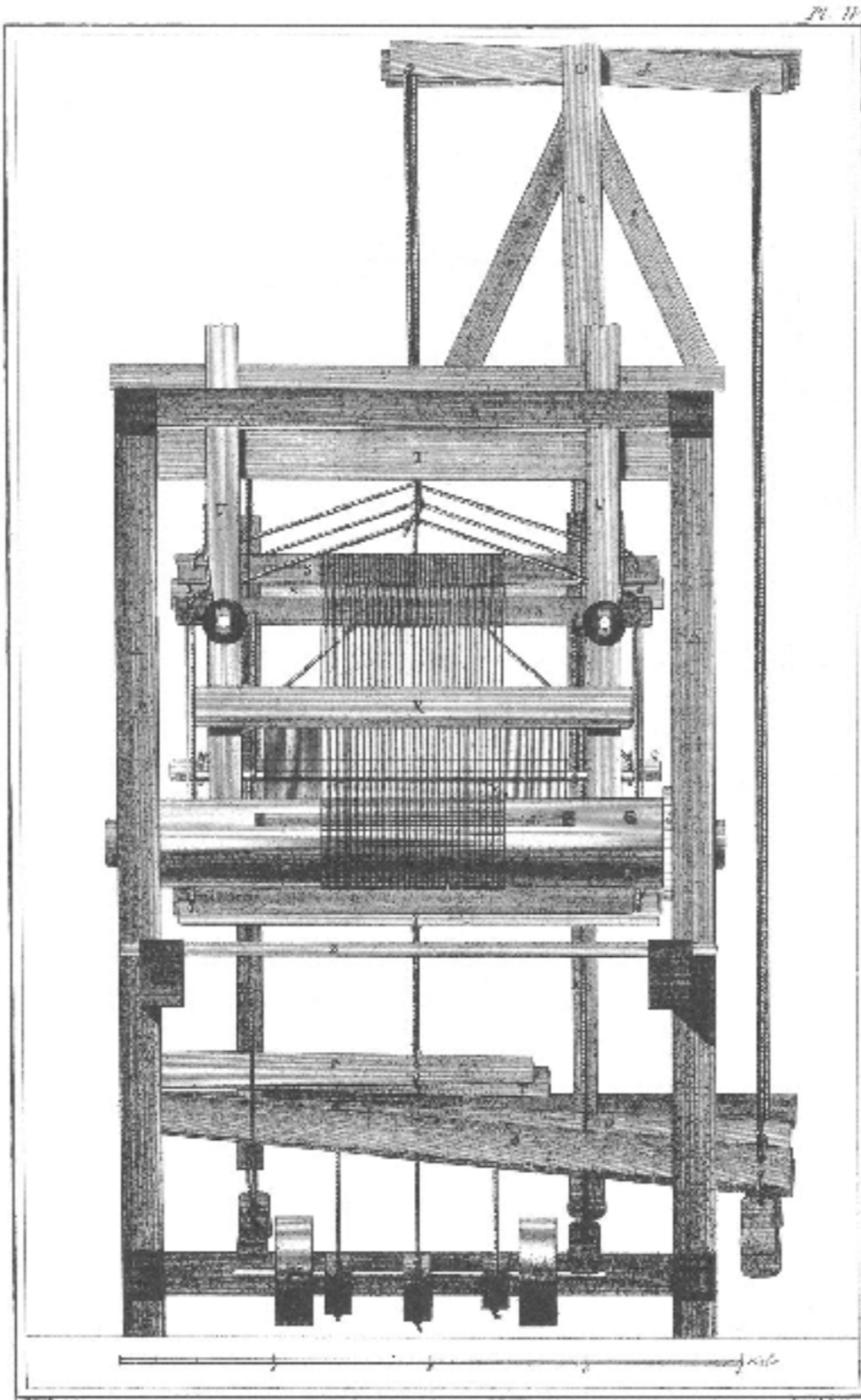

*Élévation en face du Métier à Marley.*

Loom for the Production of Marley Gauze  
The Encyclopedia of Diderot & d'Alembert 1763  
(University of Michigan)

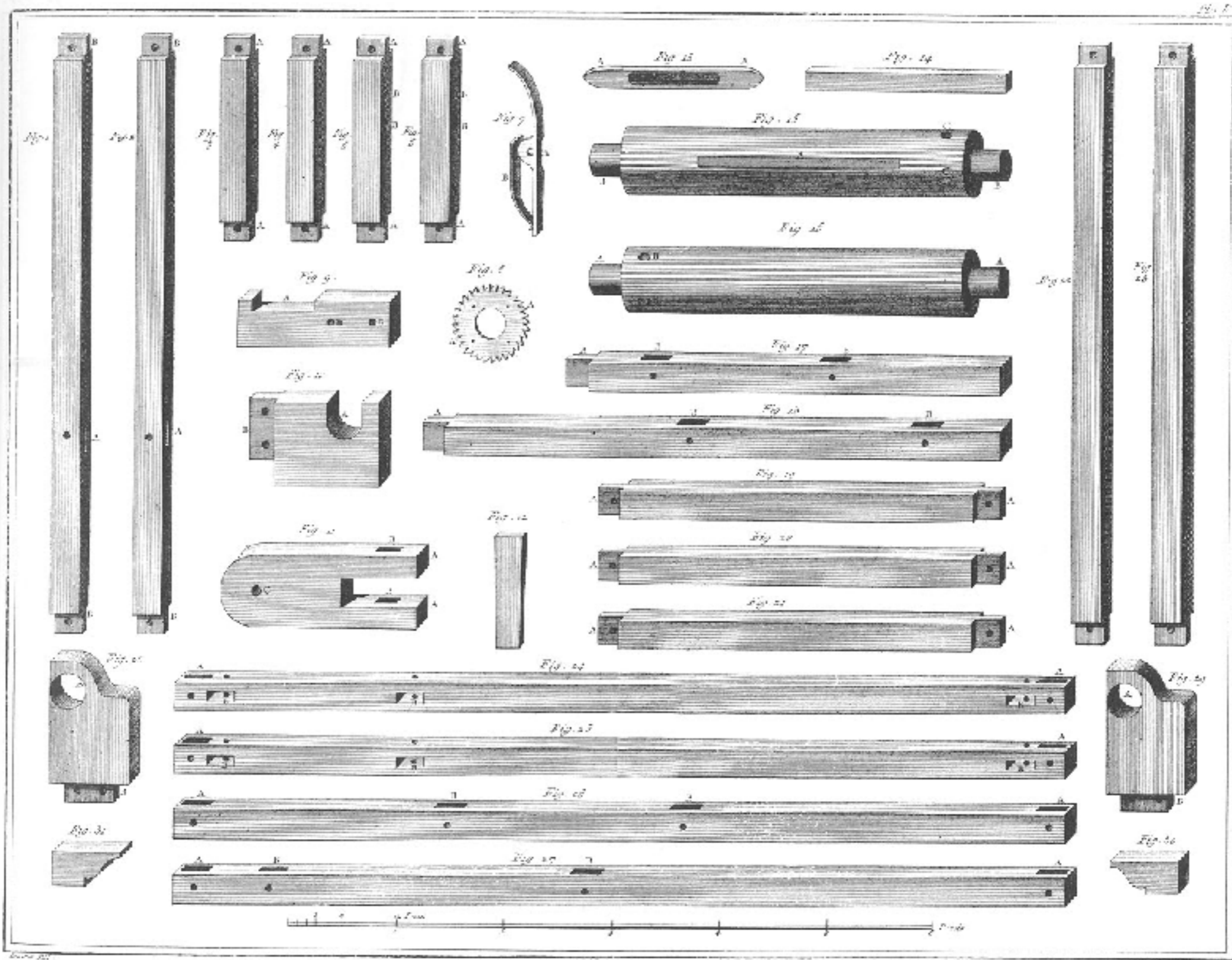

*Détail des Pièces du Métier à Marly.*

Loom for the Production of Marley Gauze  
 The Encyclopedia of Diderot & d'Alembert 1763  
 (University of Michigan)

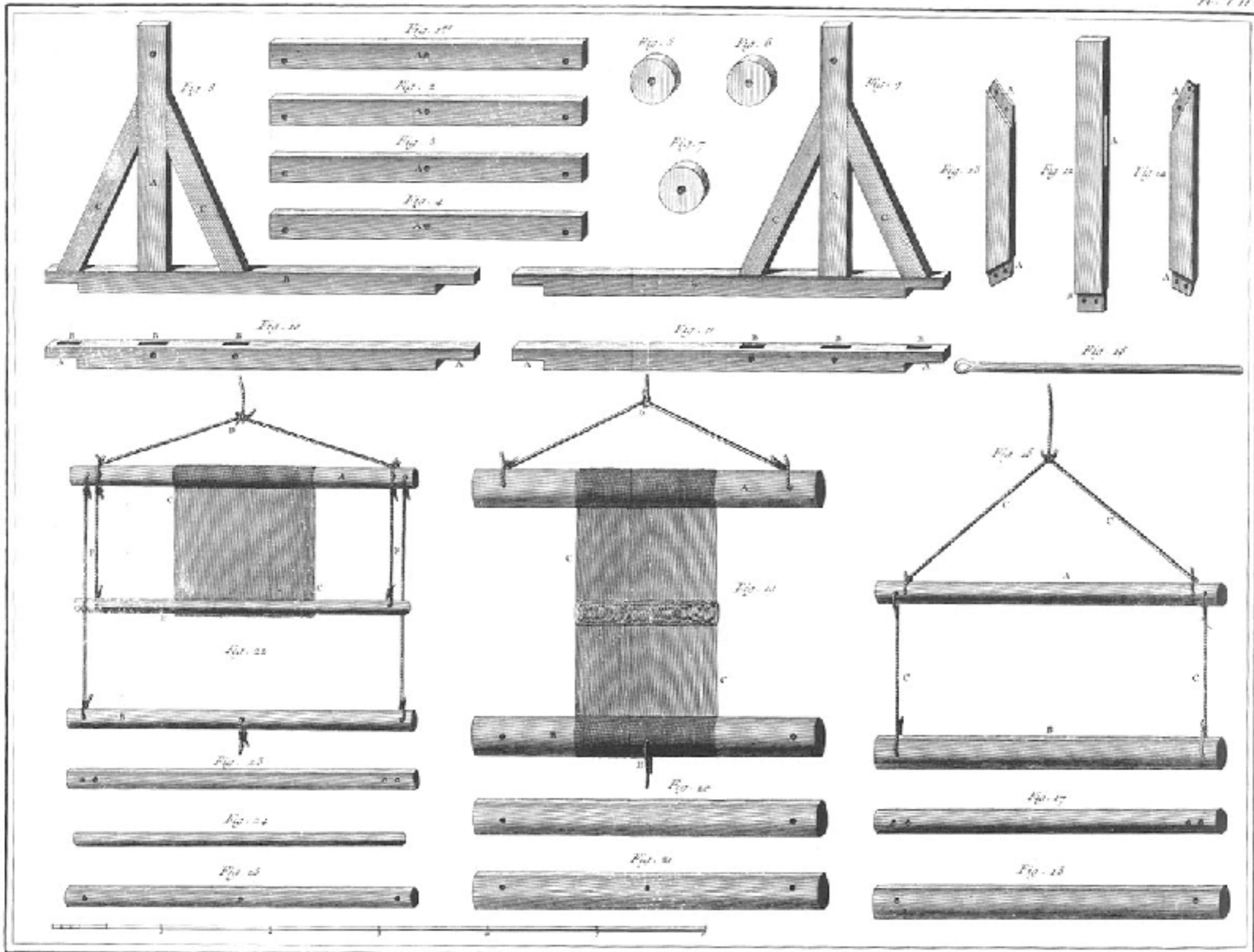

*Détail des Pièces du Métier à Marli.*

Loom for the Production of Marley Gauze  
 The Encyclopedia of Diderot & d'Alembert 1763  
 (University of Michigan)

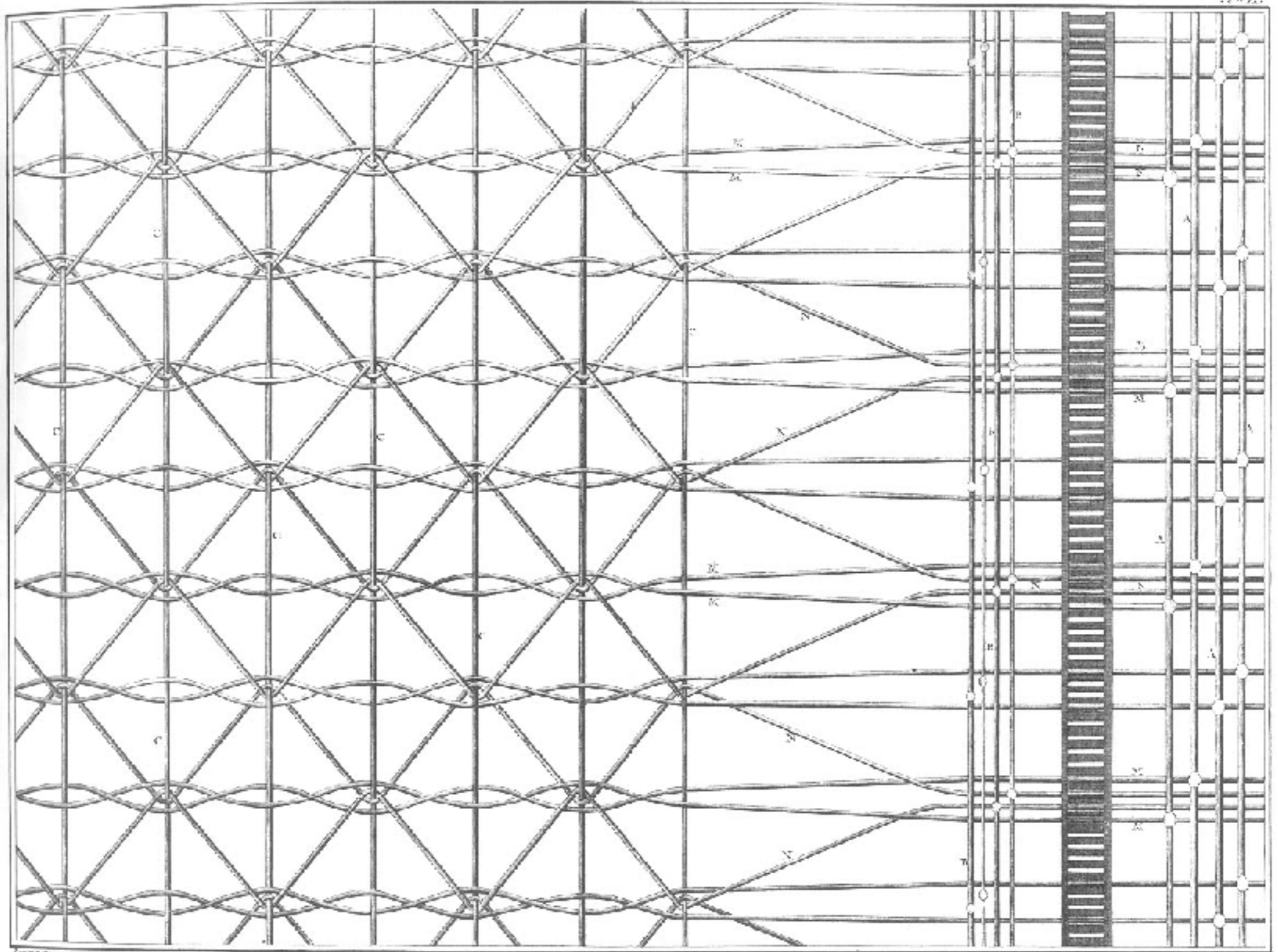

*Marley, Figure du Marley.*

Loom for the Production of Marley Gauze  
 The Encyclopedia of Diderot & d'Alembert 1763  
 (University of Michigan)

# Weaving

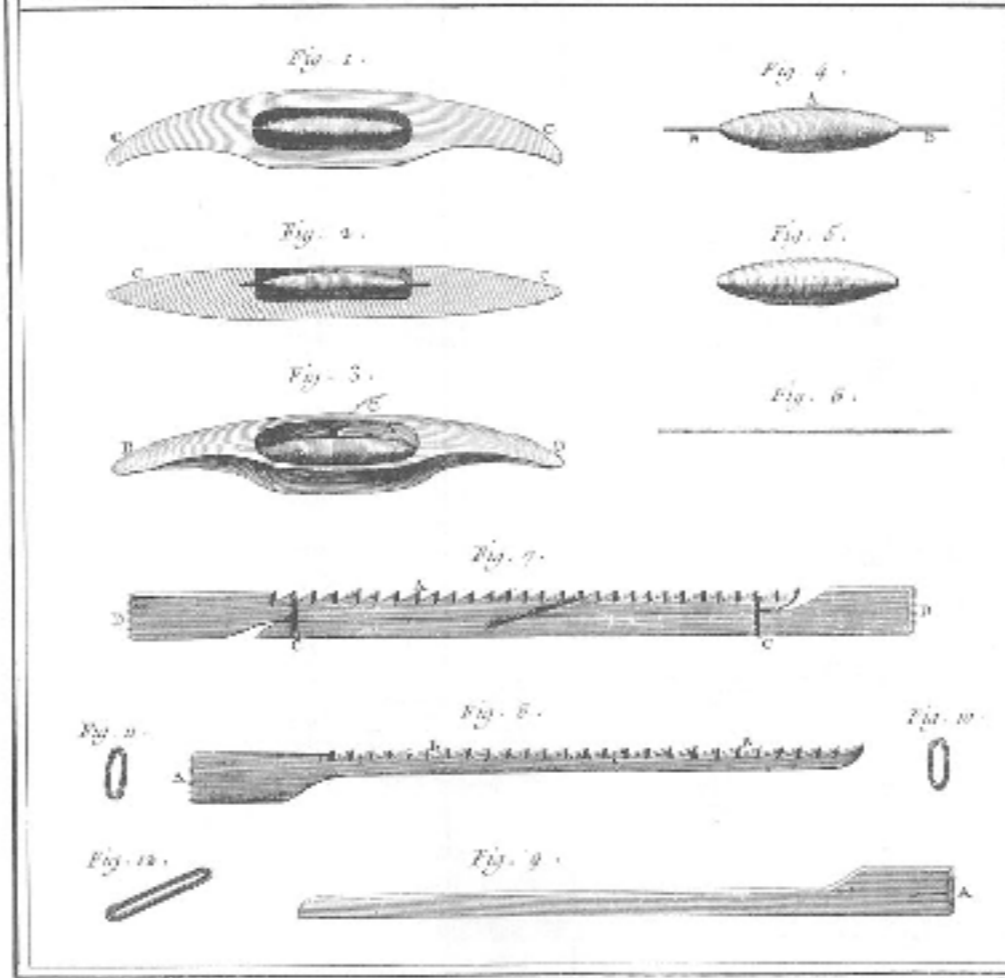
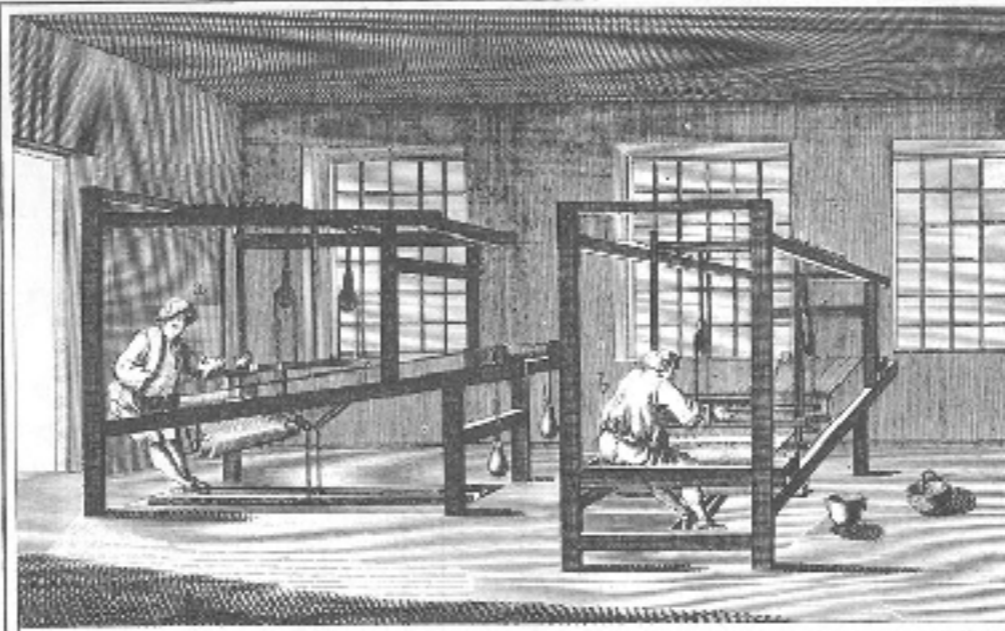

Jaquet del.

Enoch fecit

*Tisserand, Navette et Temple.*

“Tisserand, ...”  
 The Encyclopedia of Diderot & d'Alembert 1763  
 (University of Michigan)

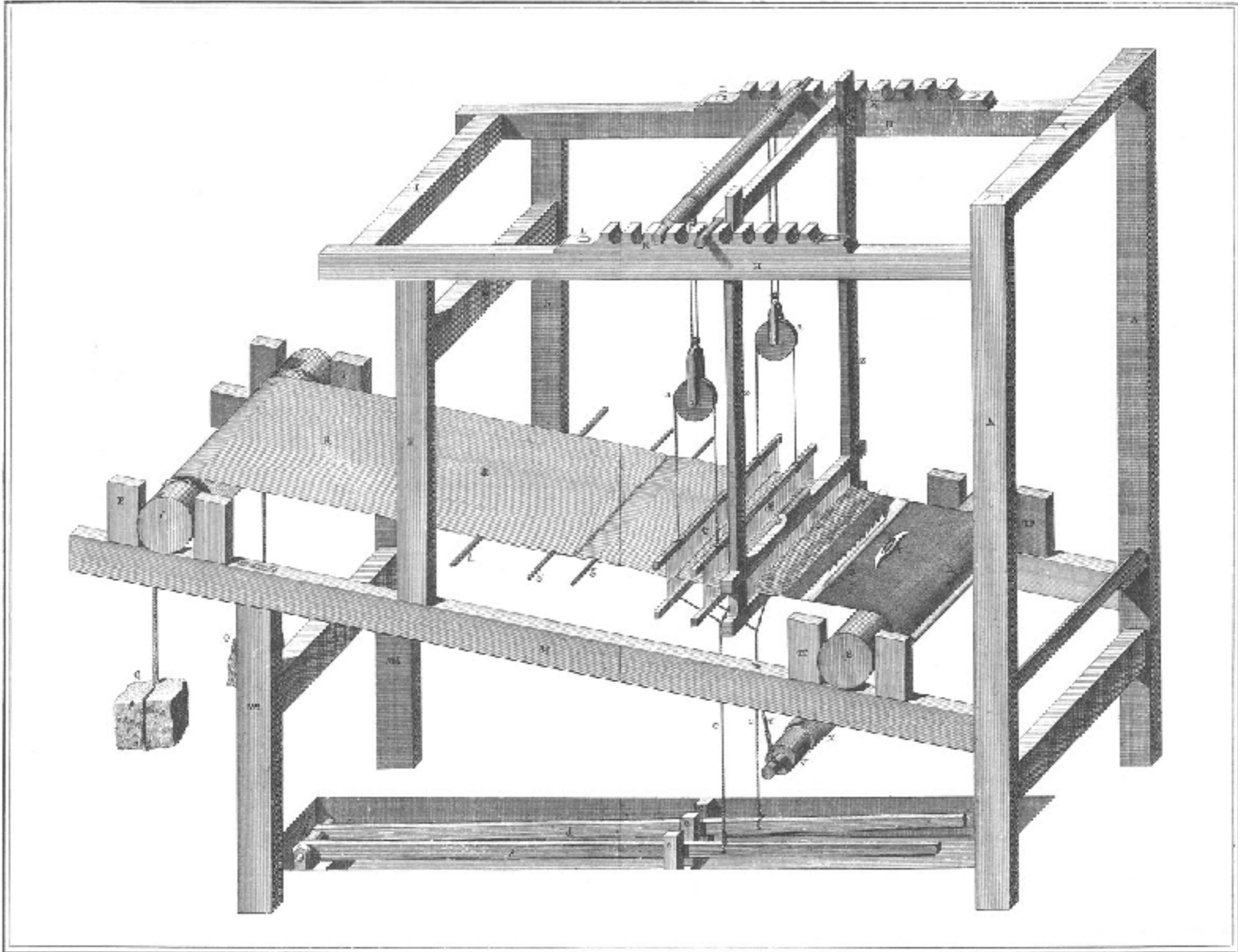

Salvo J.M.

Benard Scil.

*Tisserand, Métier.*

“Tisserand, ...”  
 The Encyclopedia of Diderot & d'Alembert 1763  
 (University of Michigan)

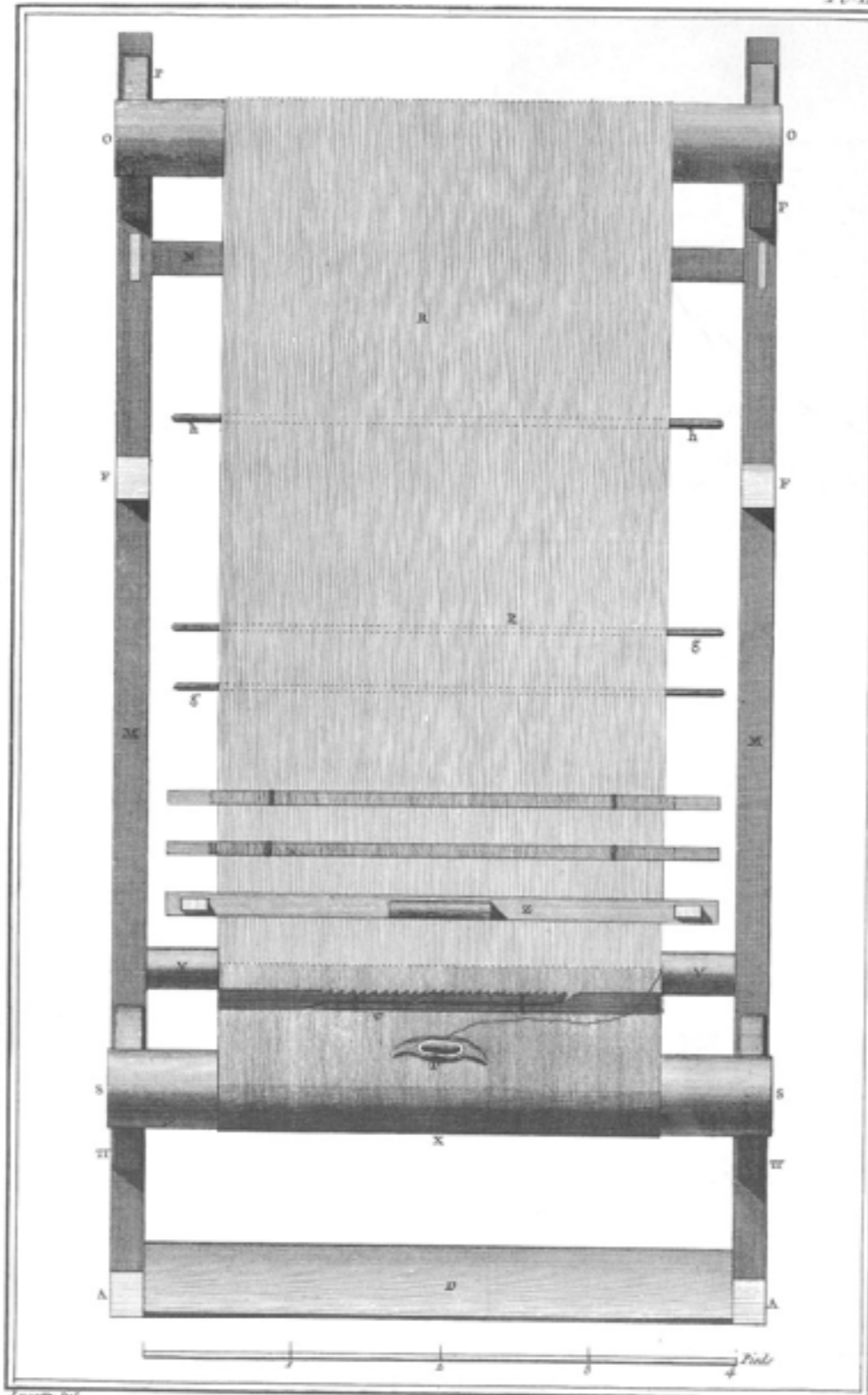

*Tisserand, Plan du Mètier.*

“Tisserand, ...”

The Encyclopedia of Diderot & d'Alembert 1763  
(University of Michigan)

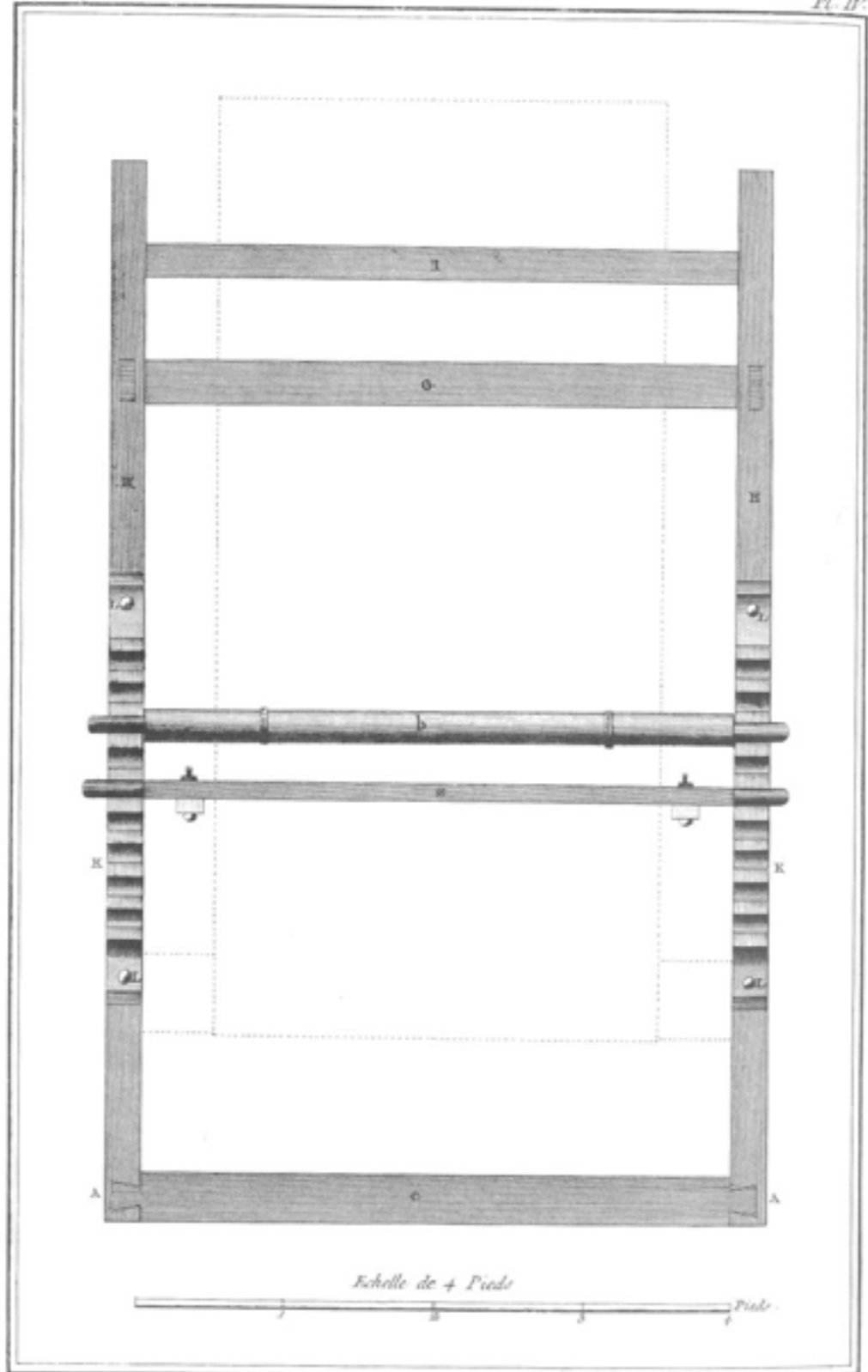

Lacelle Del.

Bernard Scul.

Tisserand, Plan du haut du Mètier à faire la Toile

“Tisserand, ...”

The Encyclopedia of Diderot & d'Alembert 1763  
(University of Michigan)

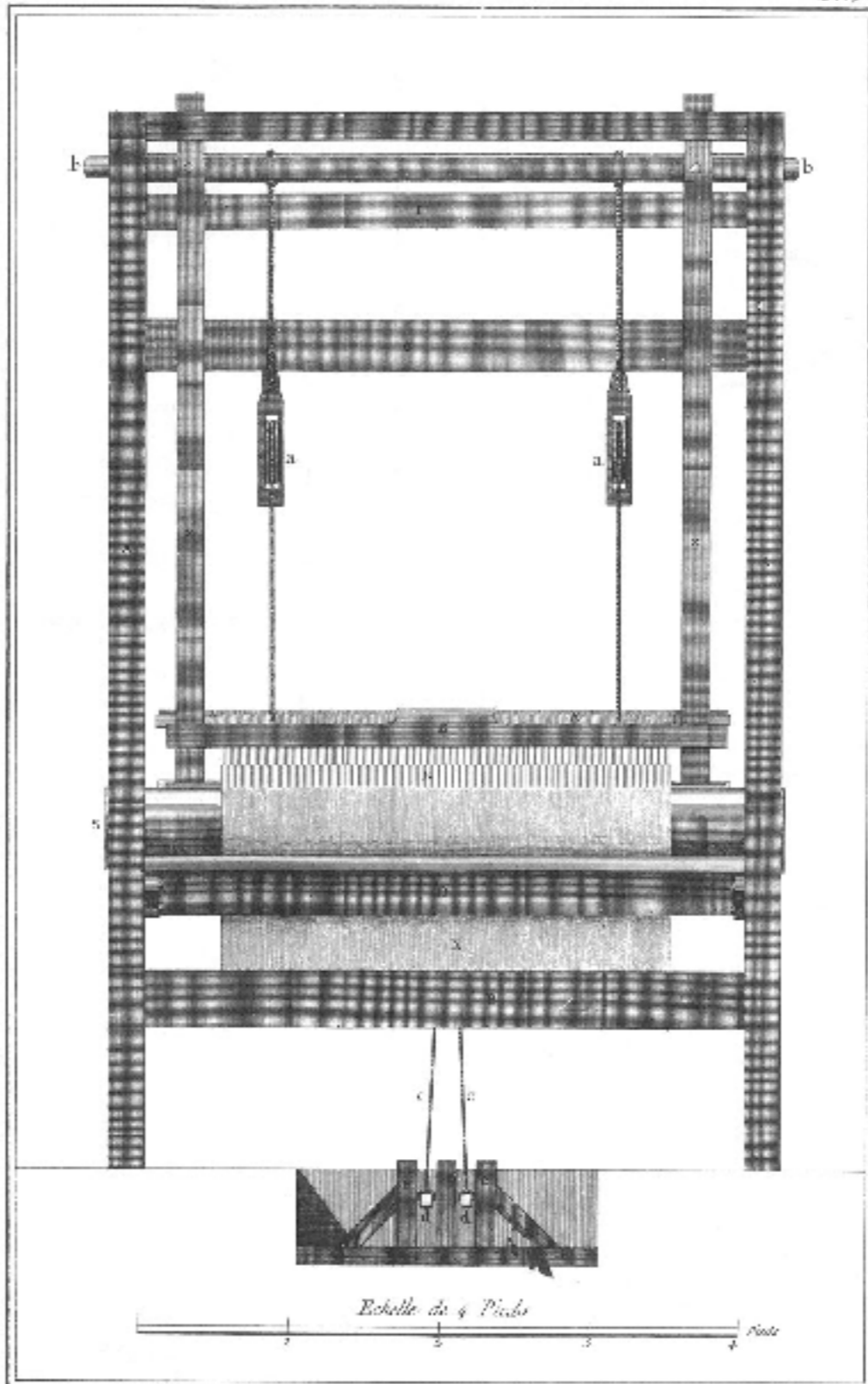

Invent. Del.

Enscul. Exec.

*Tisserand, Elevation en face du Metier à faire la Toile.*

“Tisserand, ...”

The Encyclopedia of Diderot & d'Alembert 1763  
(University of Michigan)

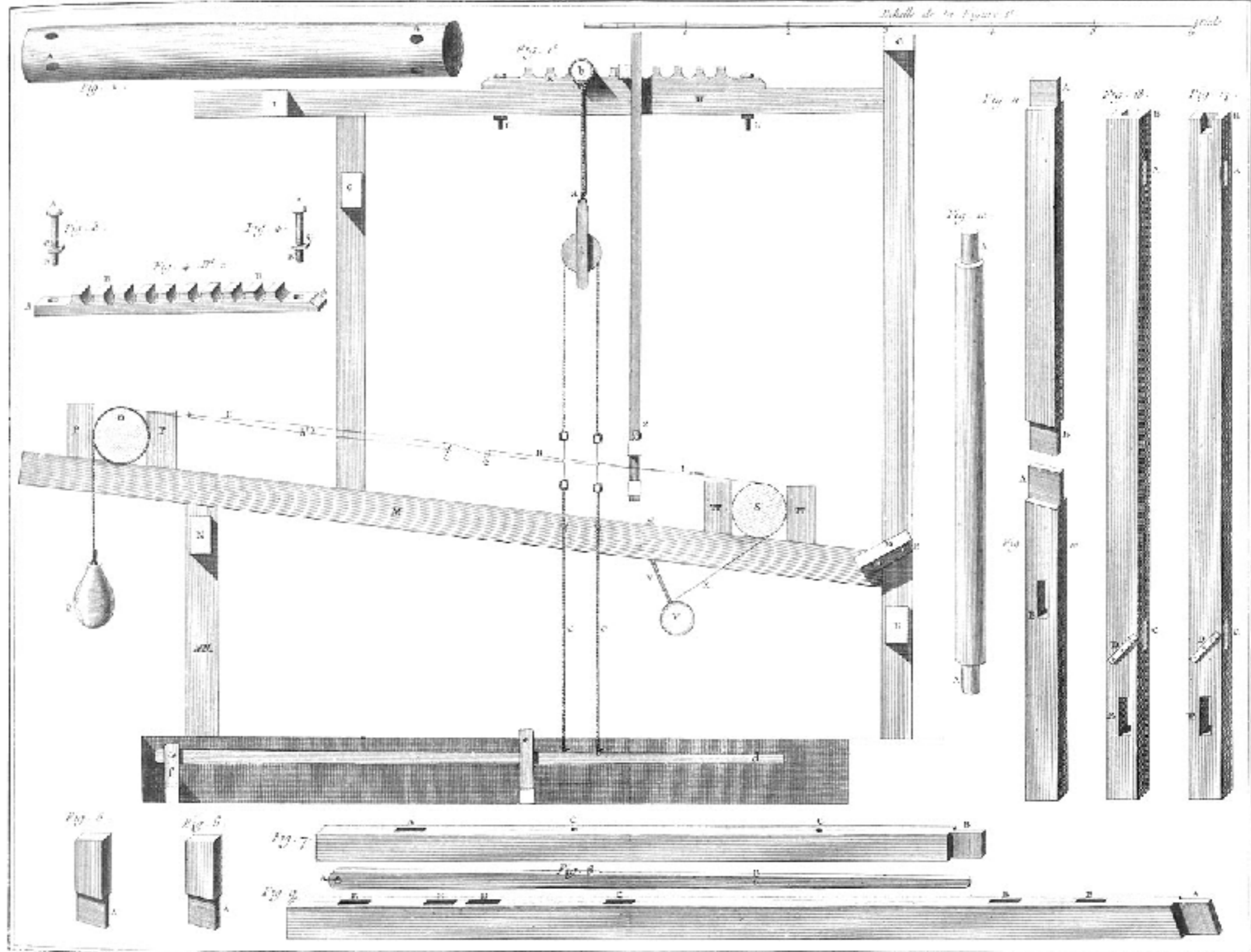

Tisserand, Elevation Laterale du Metier à faire la Toile et Détails.

“Tisserand, ...”  
 The Encyclopedia of Diderot & d'Alembert 1763  
 (University of Michigan)

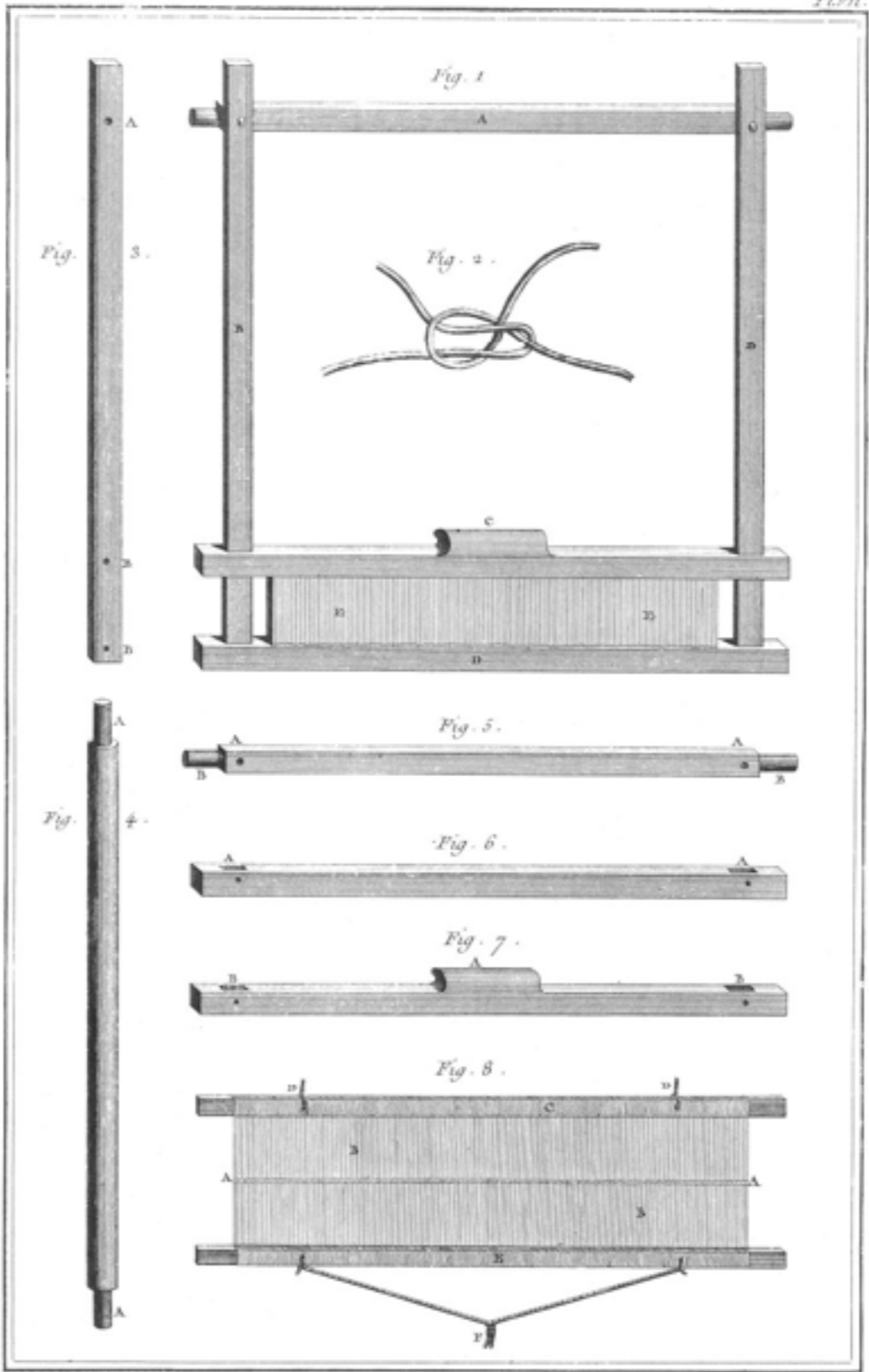

Encore Del.

Benard Esc.

Tisserand, Détails du Métier à faire la Toile.

“Tisserand, ...”

The Encyclopedia of Diderot & d'Alembert 1763  
(University of Michigan)

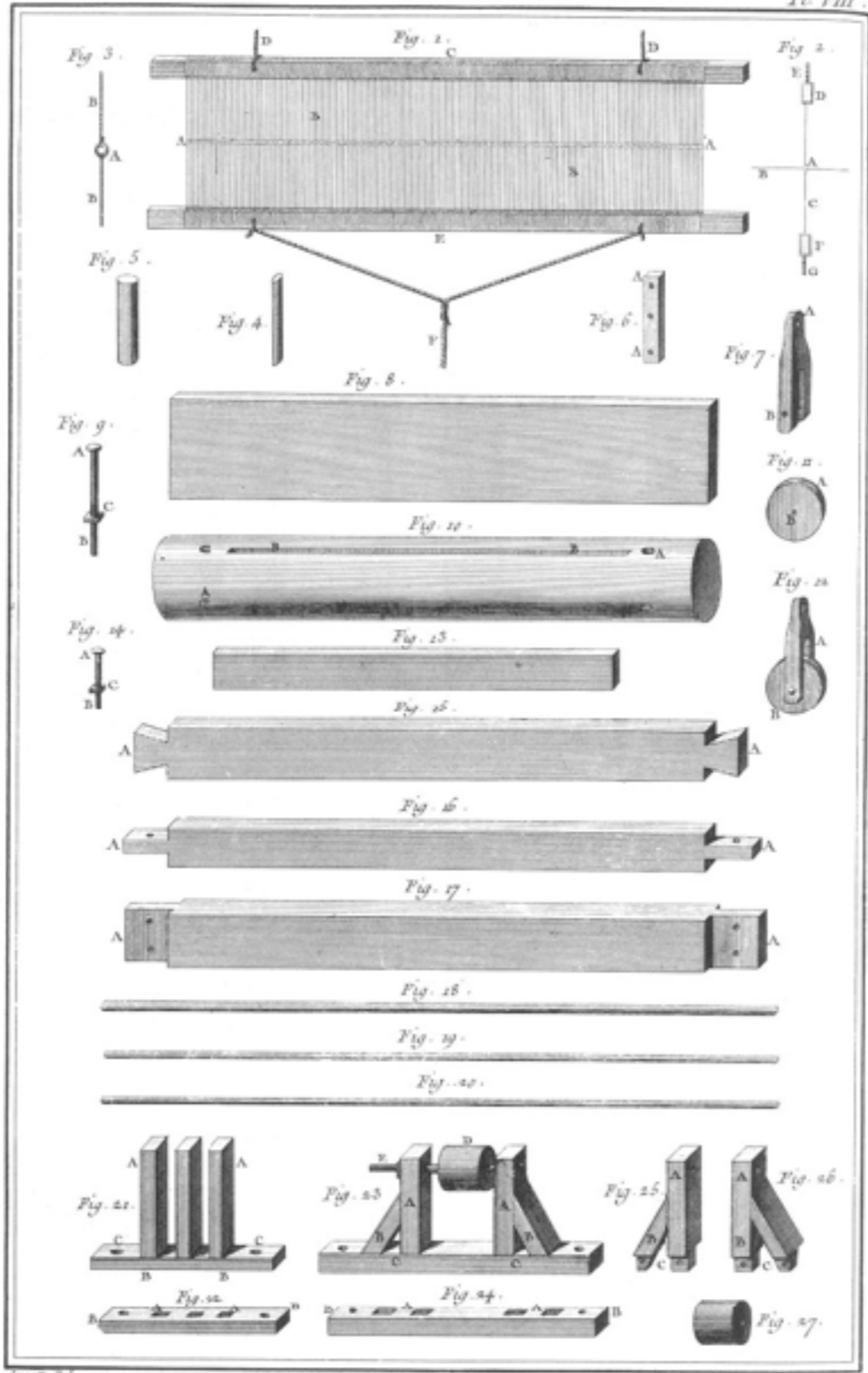

Lacotte Del. Bernard Escut.

Tisserand, Détails du Métier à faire la Toile.

“Tisserand, ...”  
The Encyclopedia of Diderot & d'Alembert 1763  
(University of Michigan)

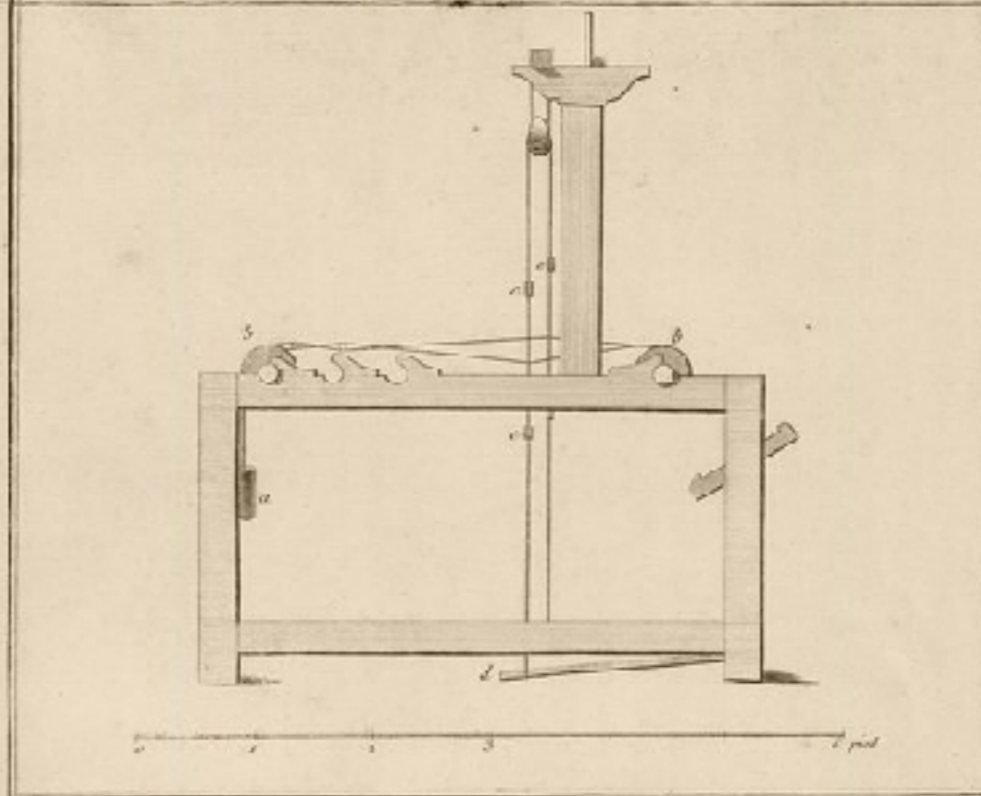
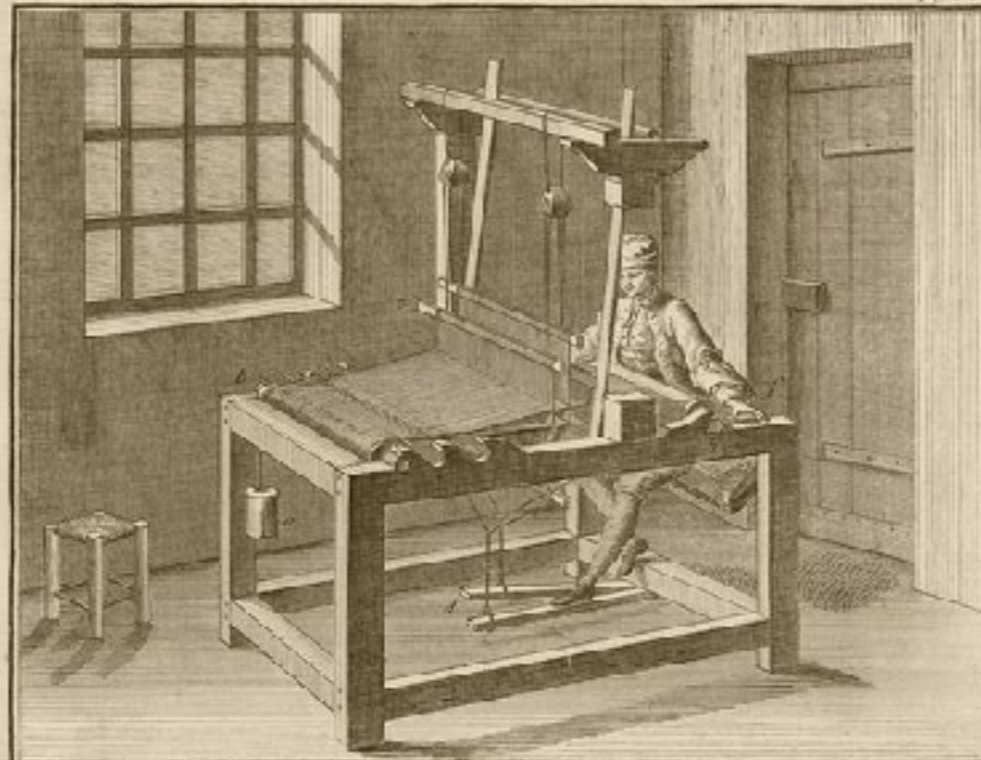

*OEconomie Rustique, Coton.*

Loom "OEconomic Rustique."  
The Encyclopedia of Diderot & d'Alembert 1763  
(Minneapolis Institute of Art)

# Gauze Production

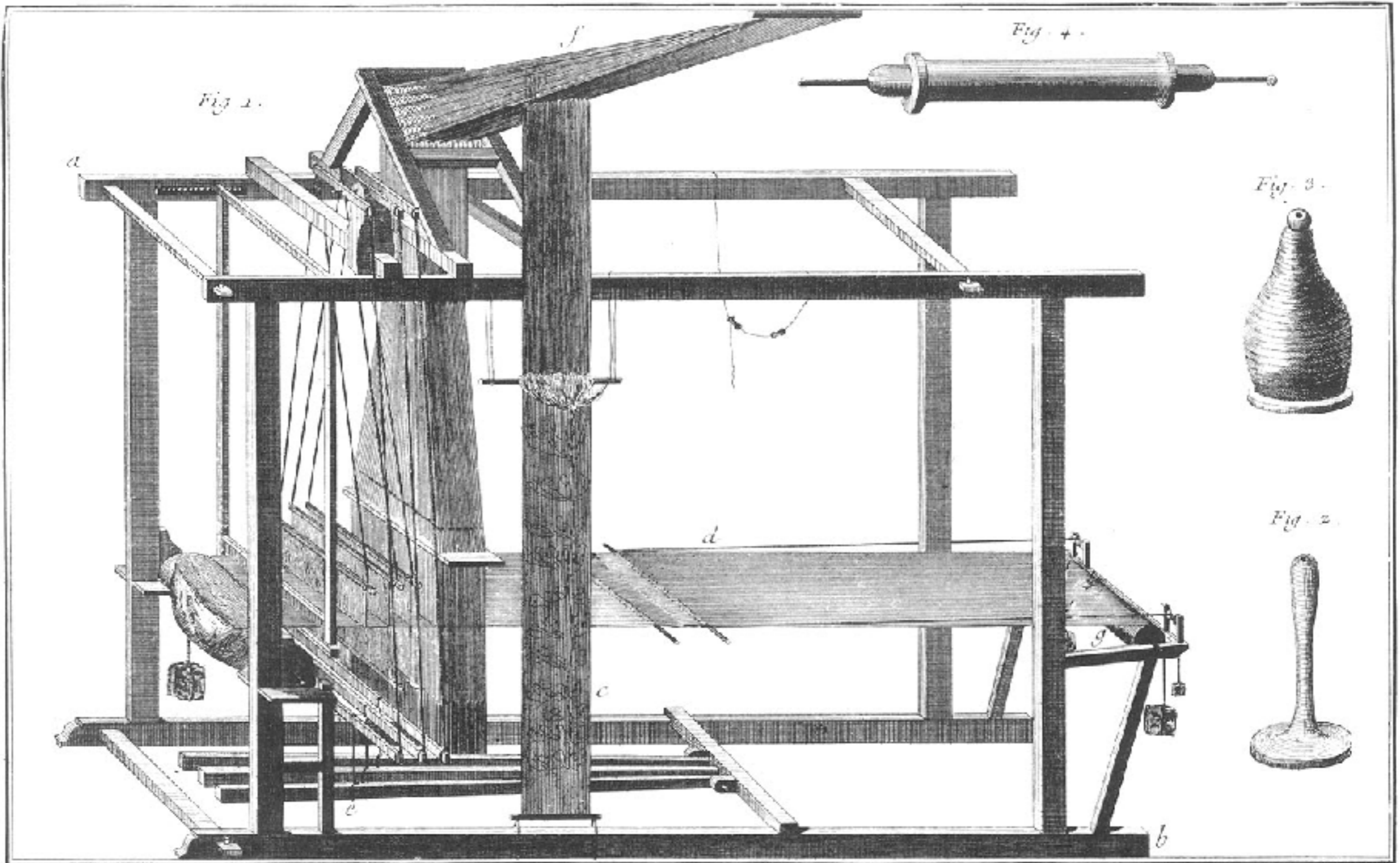

*Gazier, Métier à Gaze vu sur la longueur et Détails.*

*Bernard Pecc.*

“Gazier, ...”

The Encyclopedia of Diderot & d'Alembert 1763  
(University of Michigan)

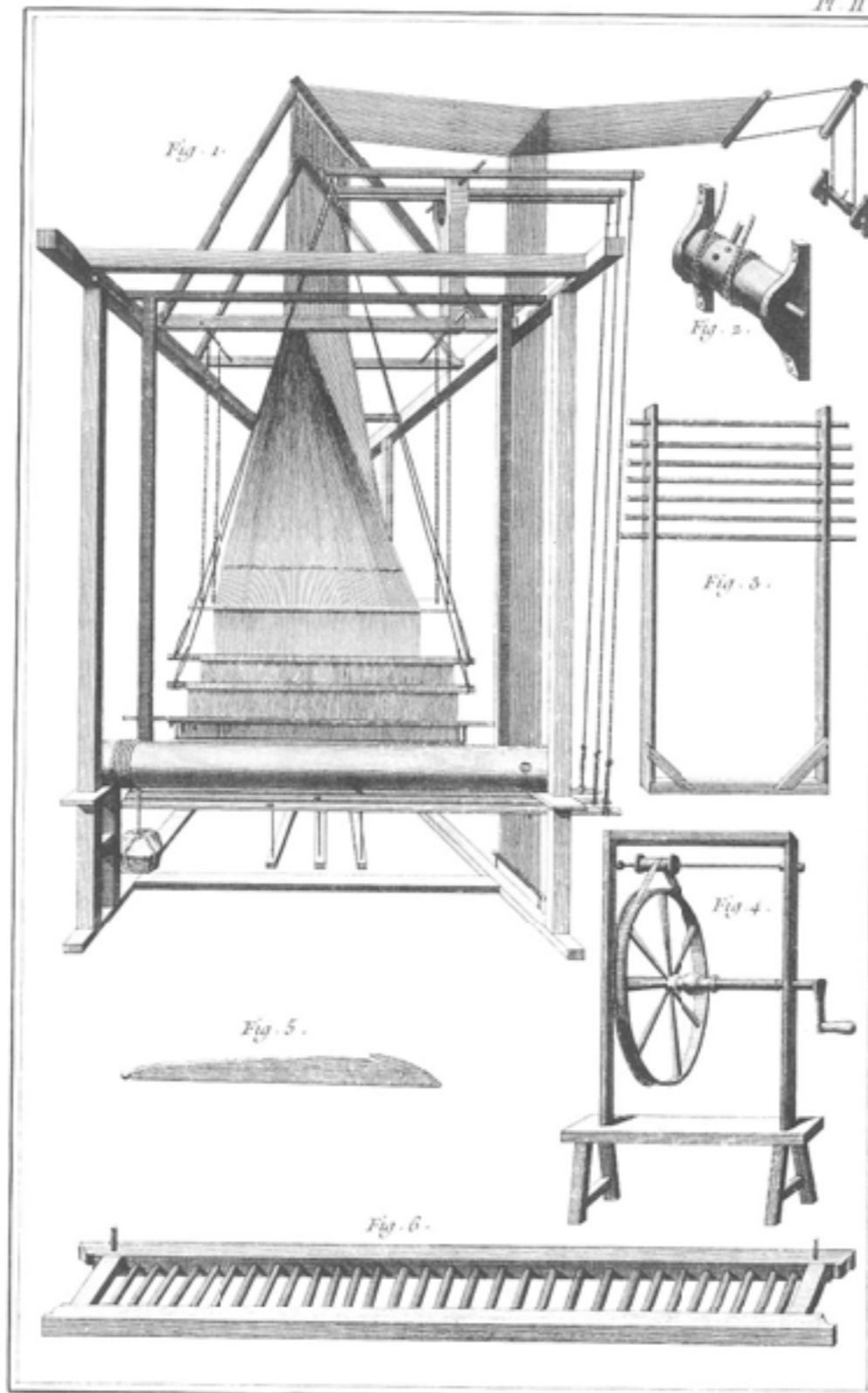

*Gazier, Métier à Gaze vu en face.*

“Gazier, ...”

The Encyclopedia of Diderot & d'Alembert 1763  
(University of Michigan)

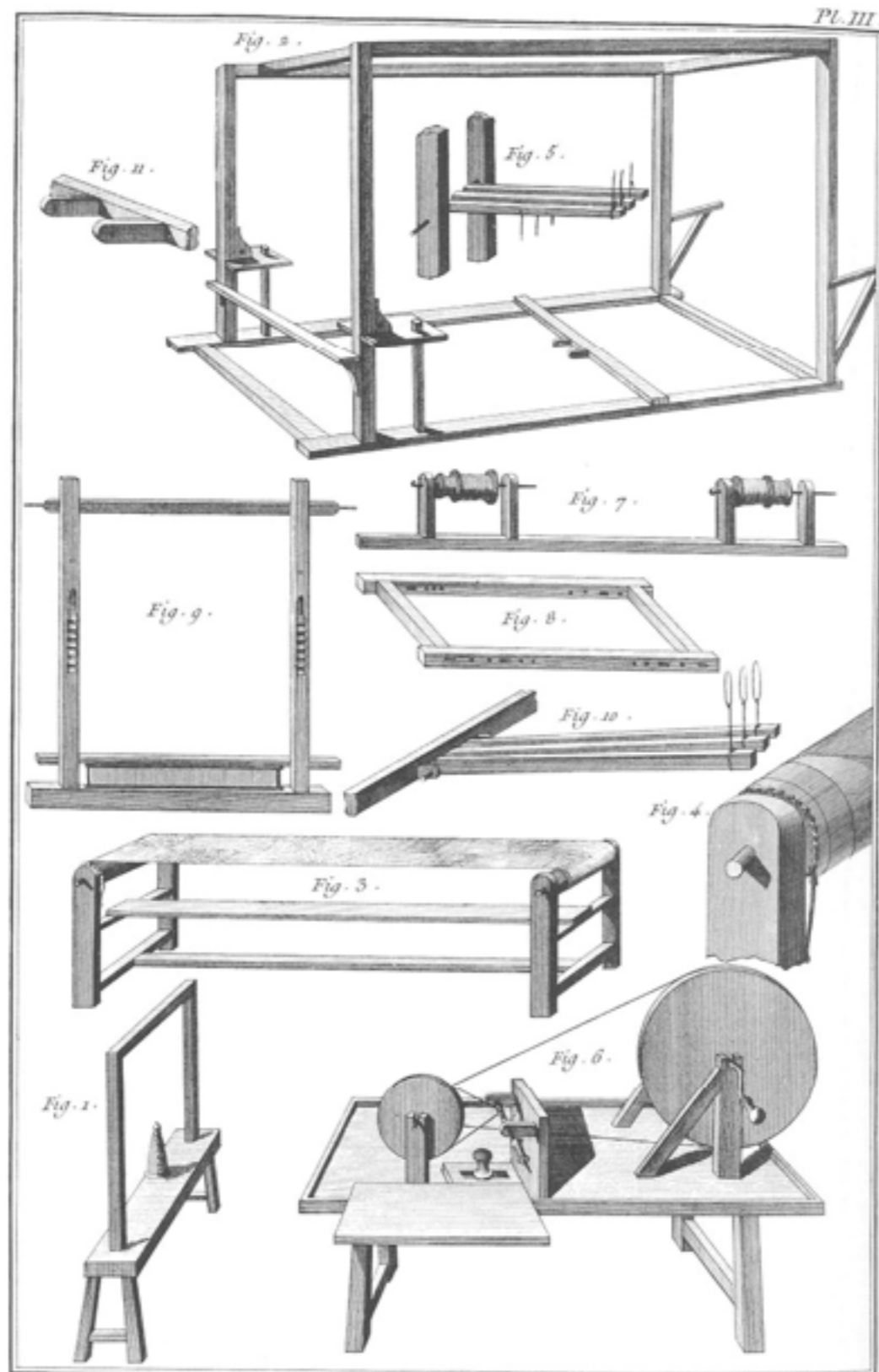

*Gazier, Développement du Mélier à Gaze &c.*

“Gazier, ...”

The Encyclopedia of Diderot & d'Alembert 1763  
(University of Michigan)

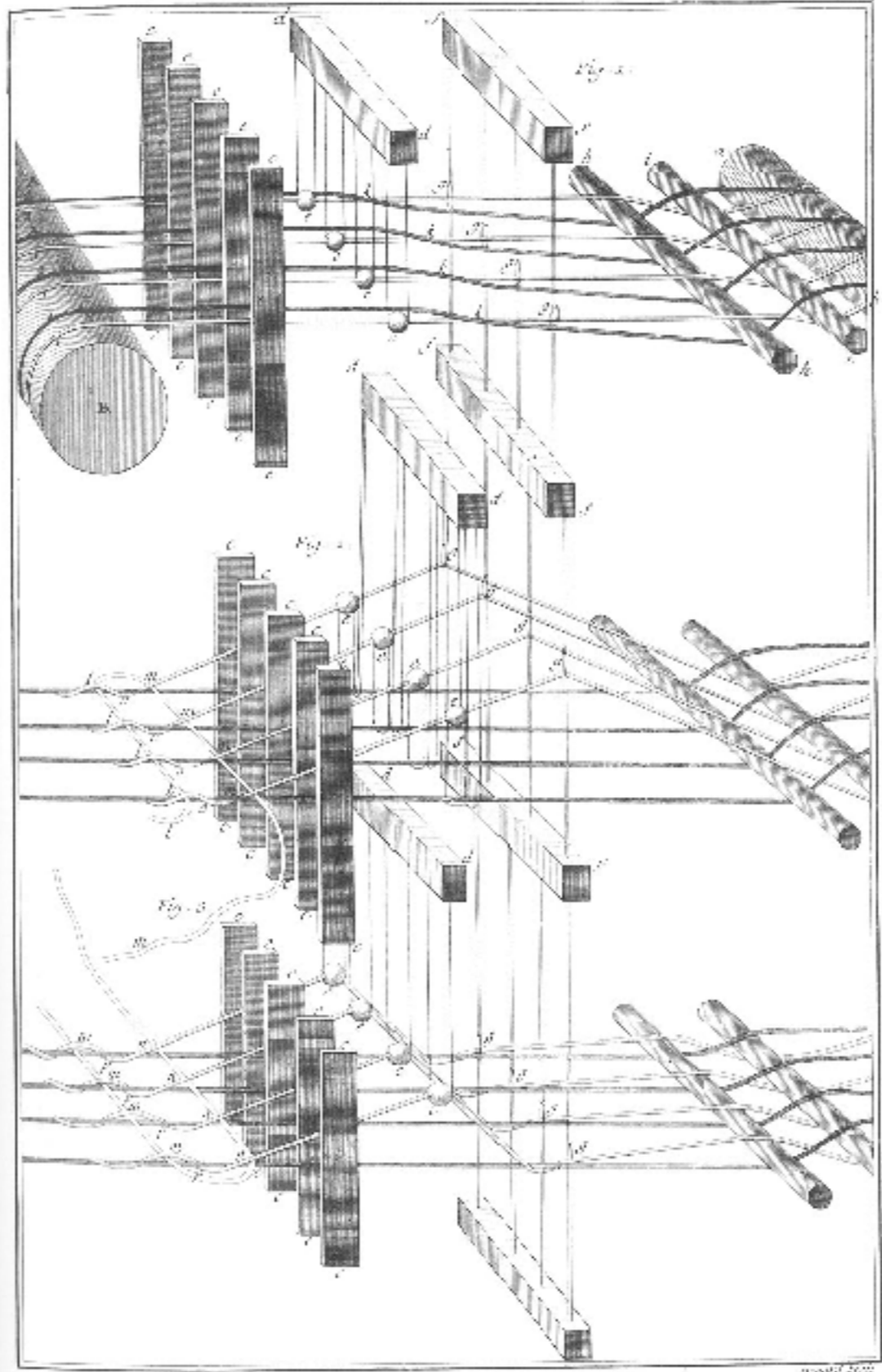

*GAZIER, Fonctions des Lasses du Méier à Gaze.*

“Gazier, ...”

The Encyclopedia of Diderot & d'Alembert 1763  
(University of Michigan)

# Silk Production

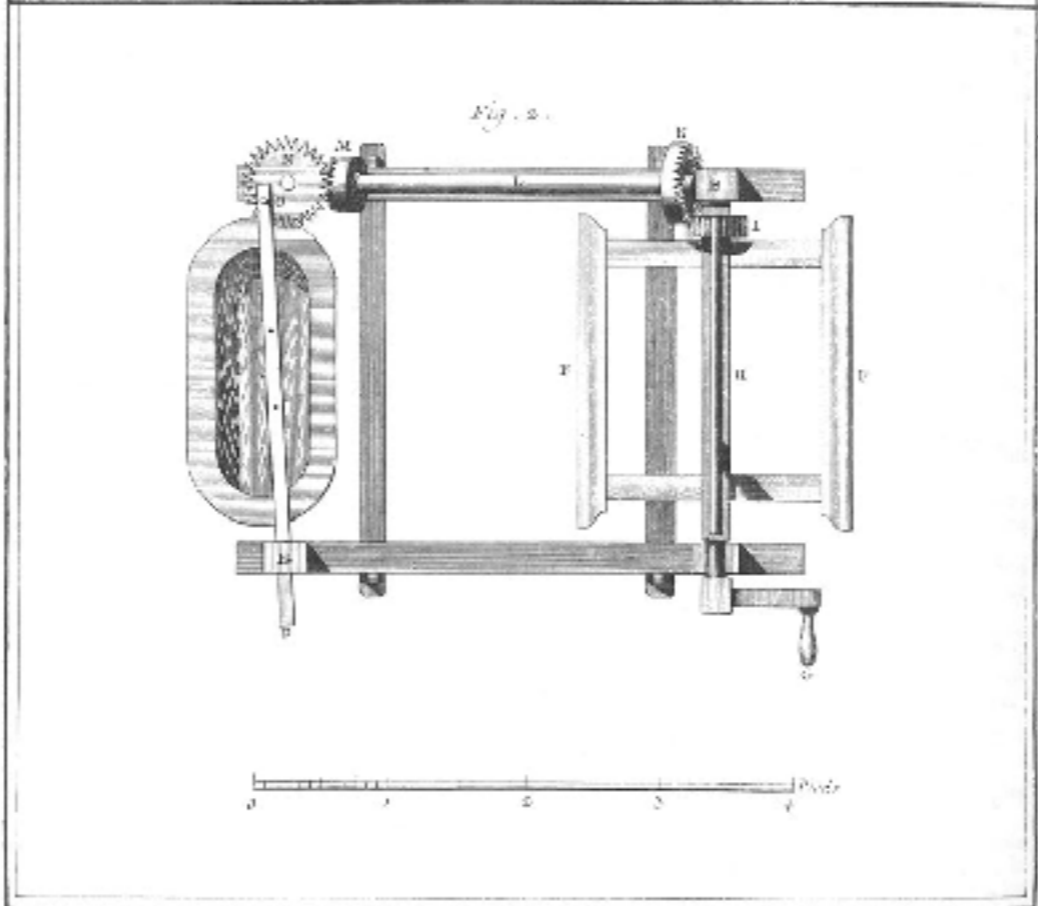
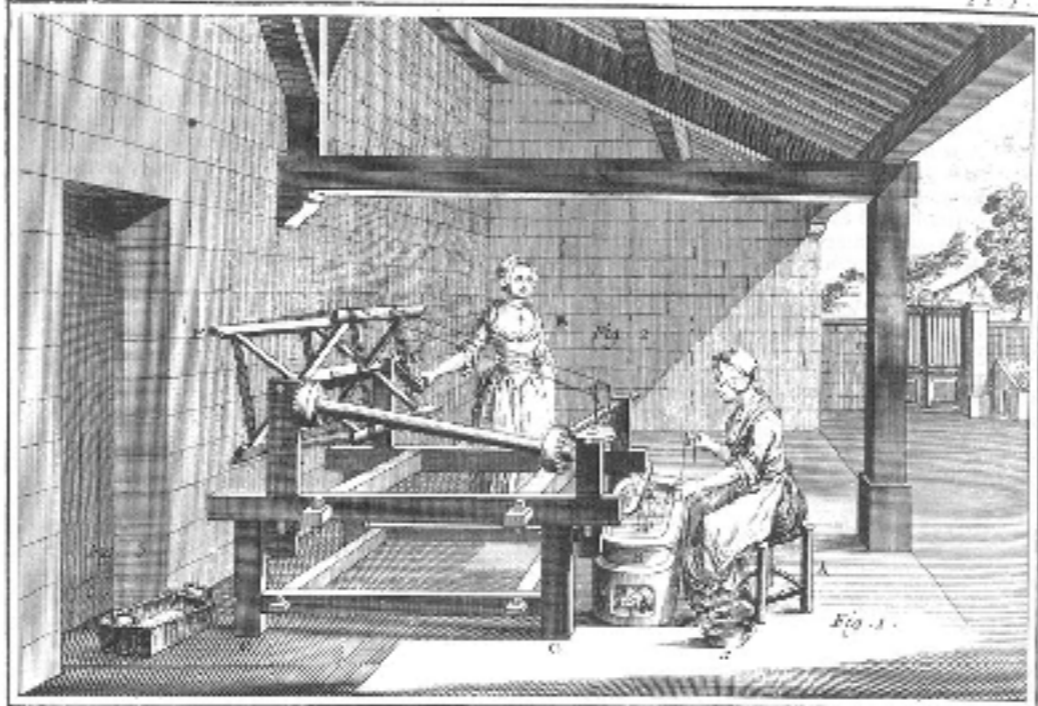

*Soierie del.* *Boed del.*

*Soierie, Tirage de la Soie et Plan du Tour de Piemont.* A

“Soierie, ...”

The Encyclopedia of Diderot & d'Alembert 1763  
(University of Michigan)

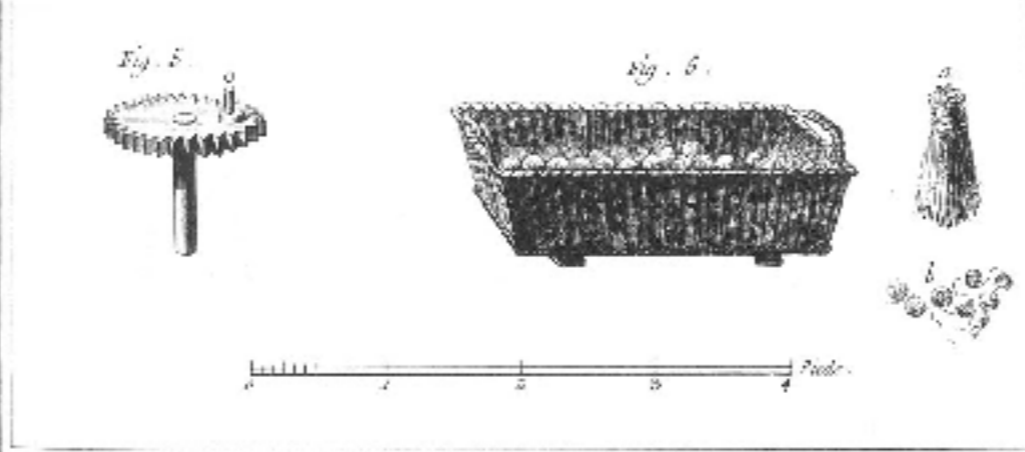
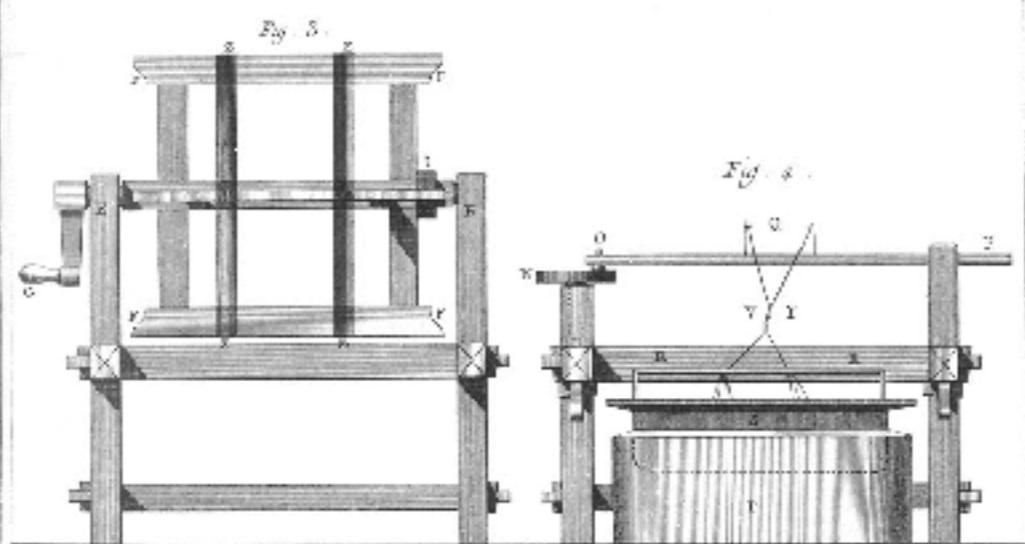
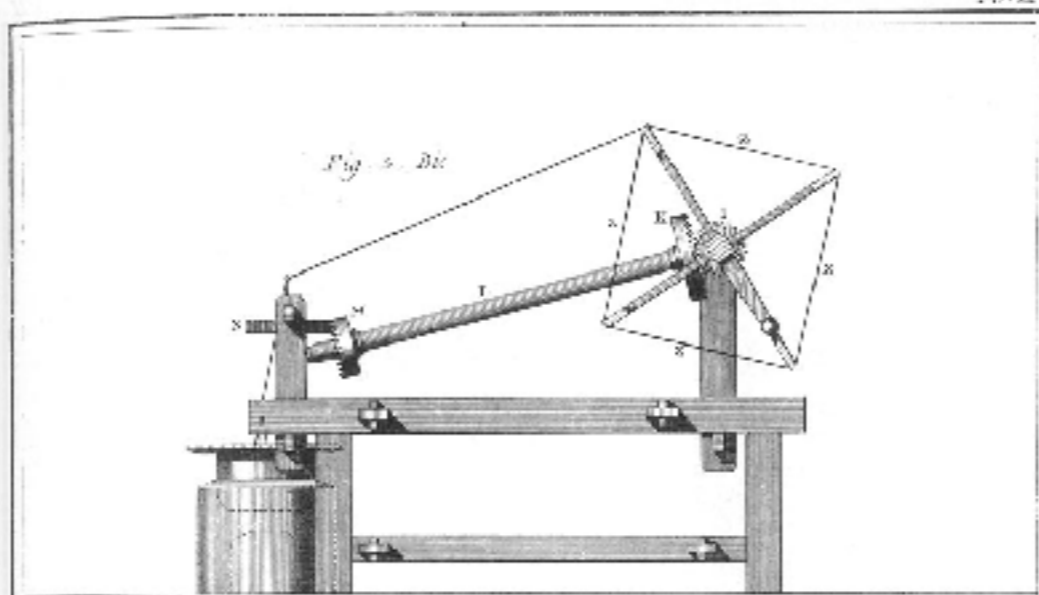

Benard del. Benard fecit.

Soierie, développemens du Tour de Piemont. B

“Soierie, ...”

The Encyclopedia of Diderot & d'Alembert 1763  
(University of Michigan)

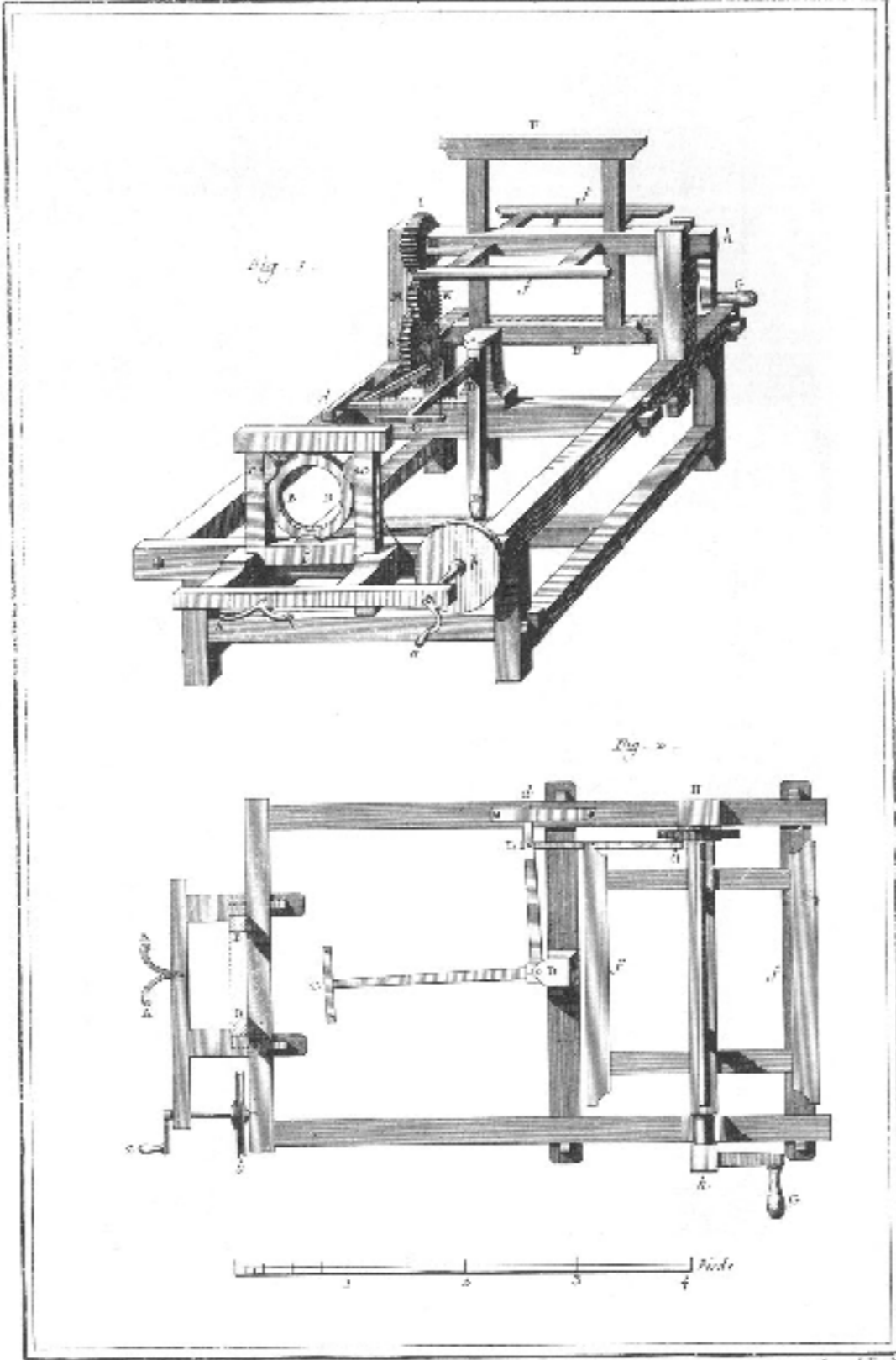

Benard Del.

Benard Sculp.

Soierie, Tour de M. de Vaumason.

C

“Soierie, ...”

The Encyclopedia of Diderot & d'Alembert 1763  
(University of Michigan)

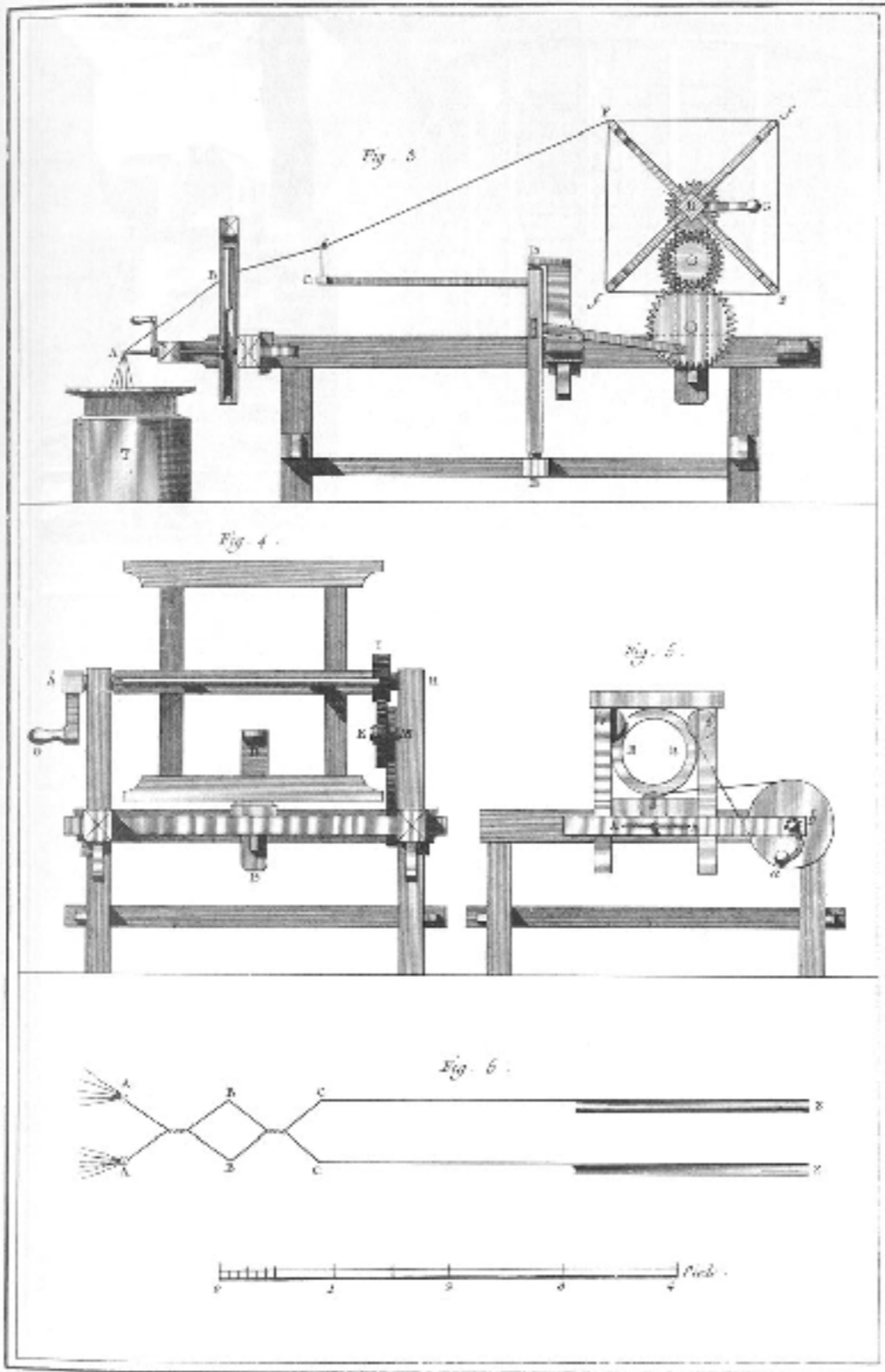

Benard del. Benard fecit.

Soierie, Developpemens du Tour de M<sup>r</sup> de Vaucanson

“Soierie, ...”

The Encyclopedia of Diderot & d'Alembert 1763  
(University of Michigan)

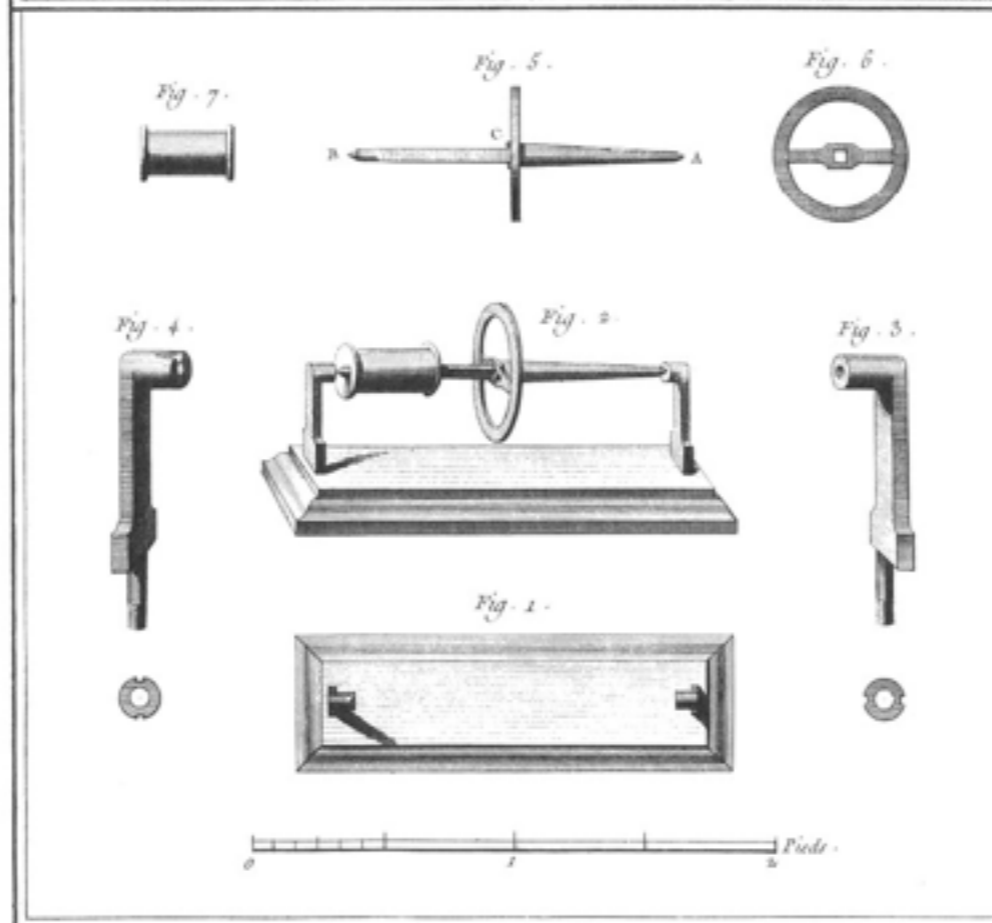
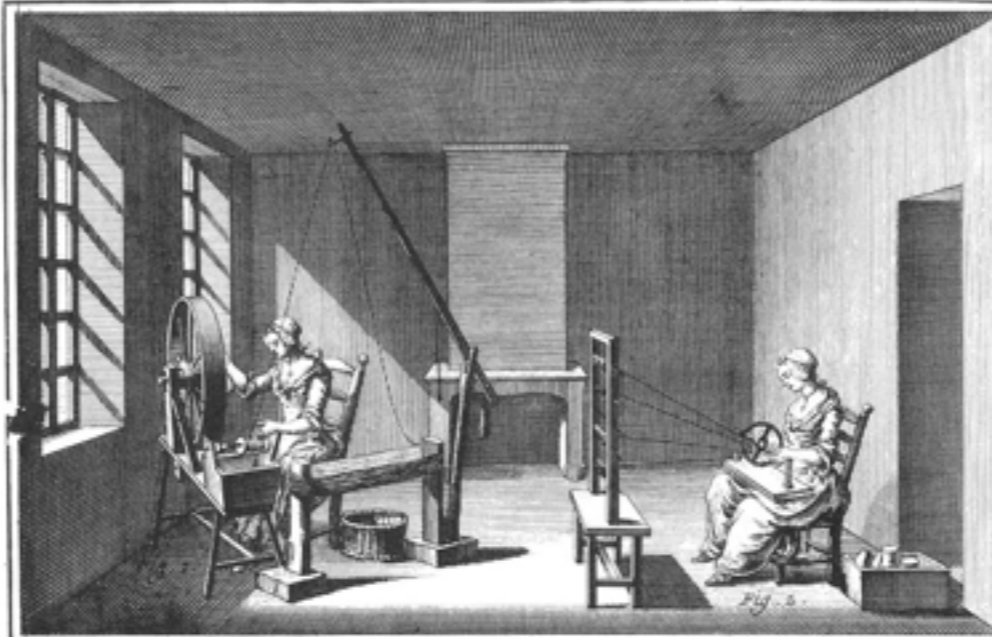

*Soierie, névidage de la soie sur le Tour d'Espagne, Doublage et développement de l'Escaladou.*

“Soierie, ...”

The Encyclopedia of Diderot & d'Alembert 1763  
(University of Michigan)

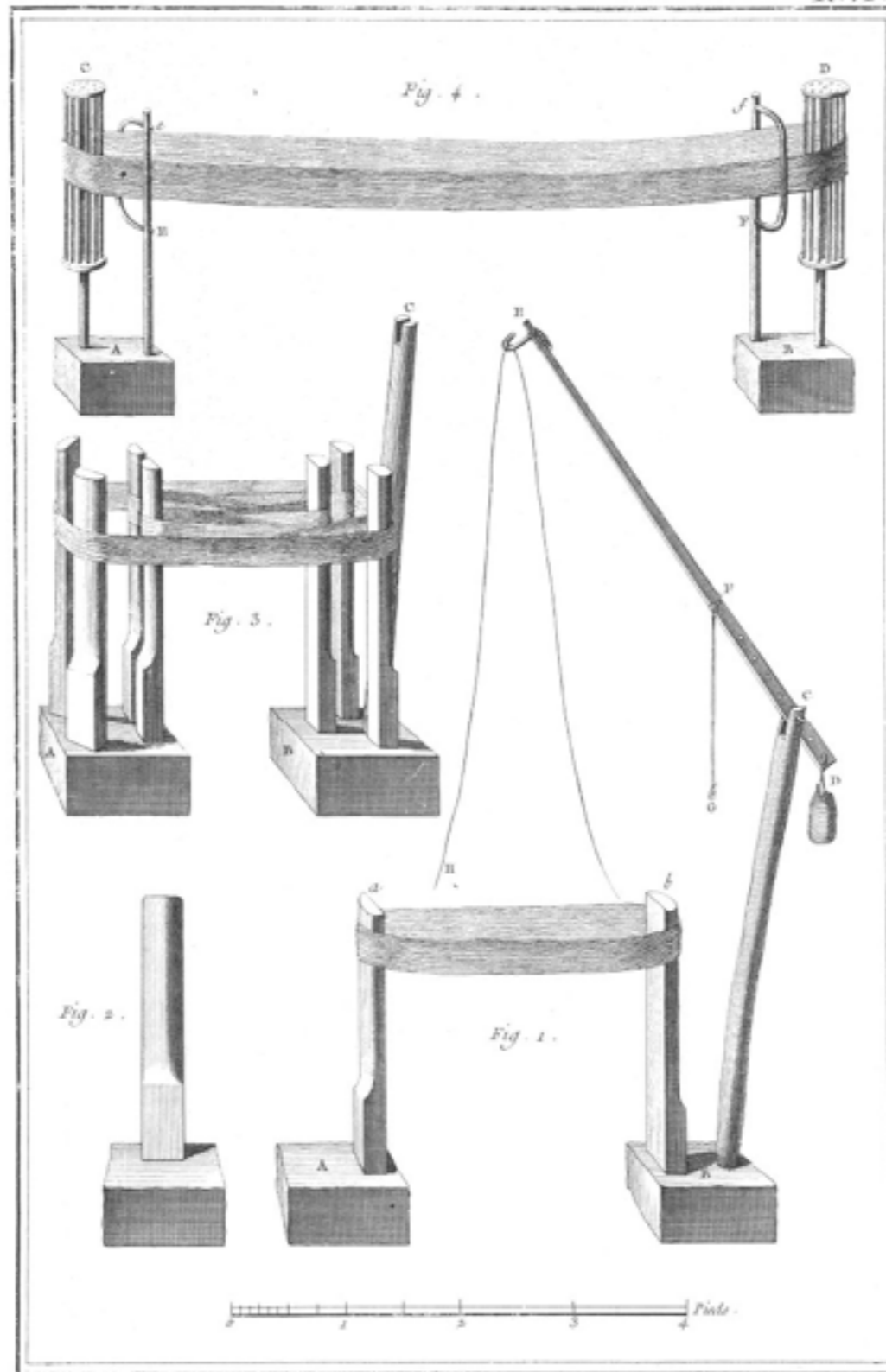

Benard del.

Benard fecit.

*Soierie, Dévidage de la Soie, Tour d'Espagne, Campanas &c. F*

“Soierie, ...”

The Encyclopedia of Diderot & d'Alembert 1763  
(University of Michigan)

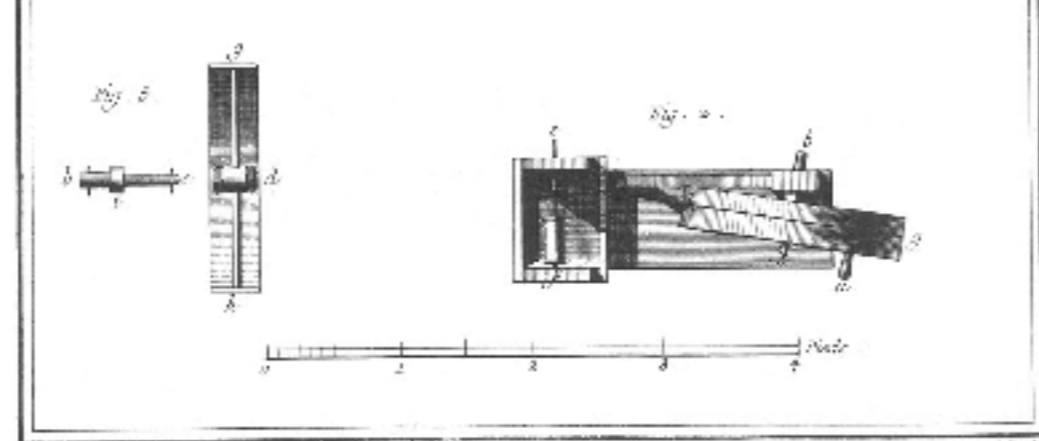
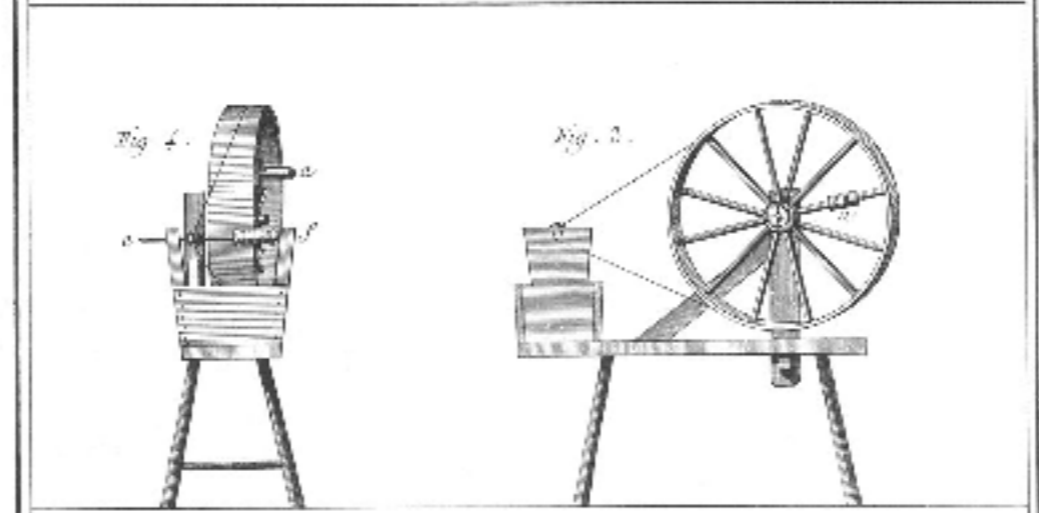
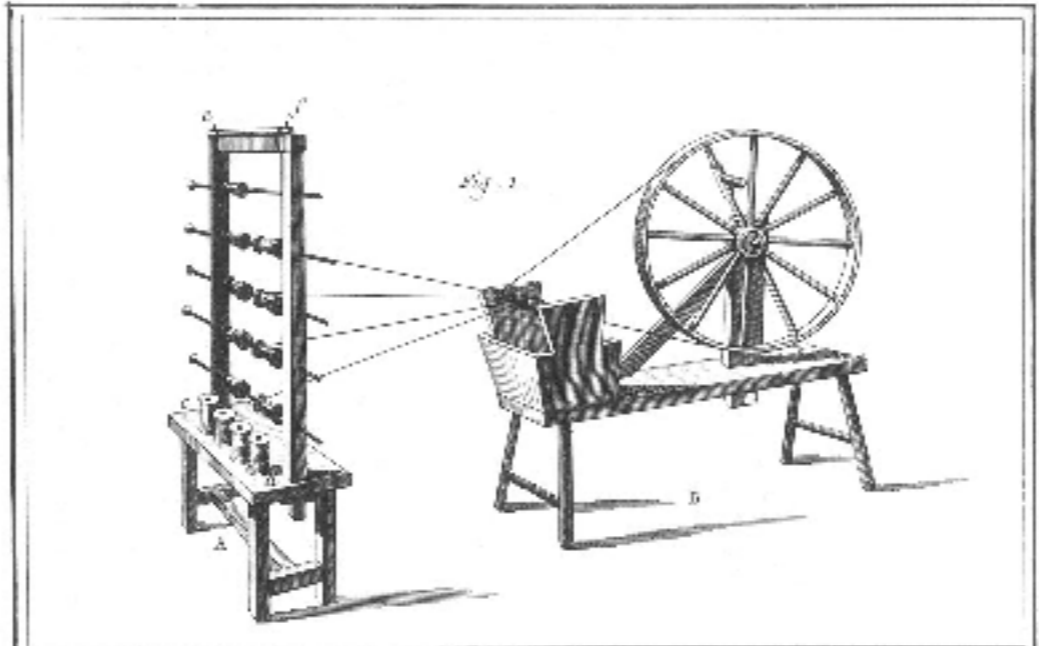

Gravé par Del. Dessiné par Enl.

*Soierie, Doublage des Soies, Construction du Rouet.* G

“Soierie, ...”

The Encyclopedia of Diderot & d'Alembert 1763  
(University of Michigan)

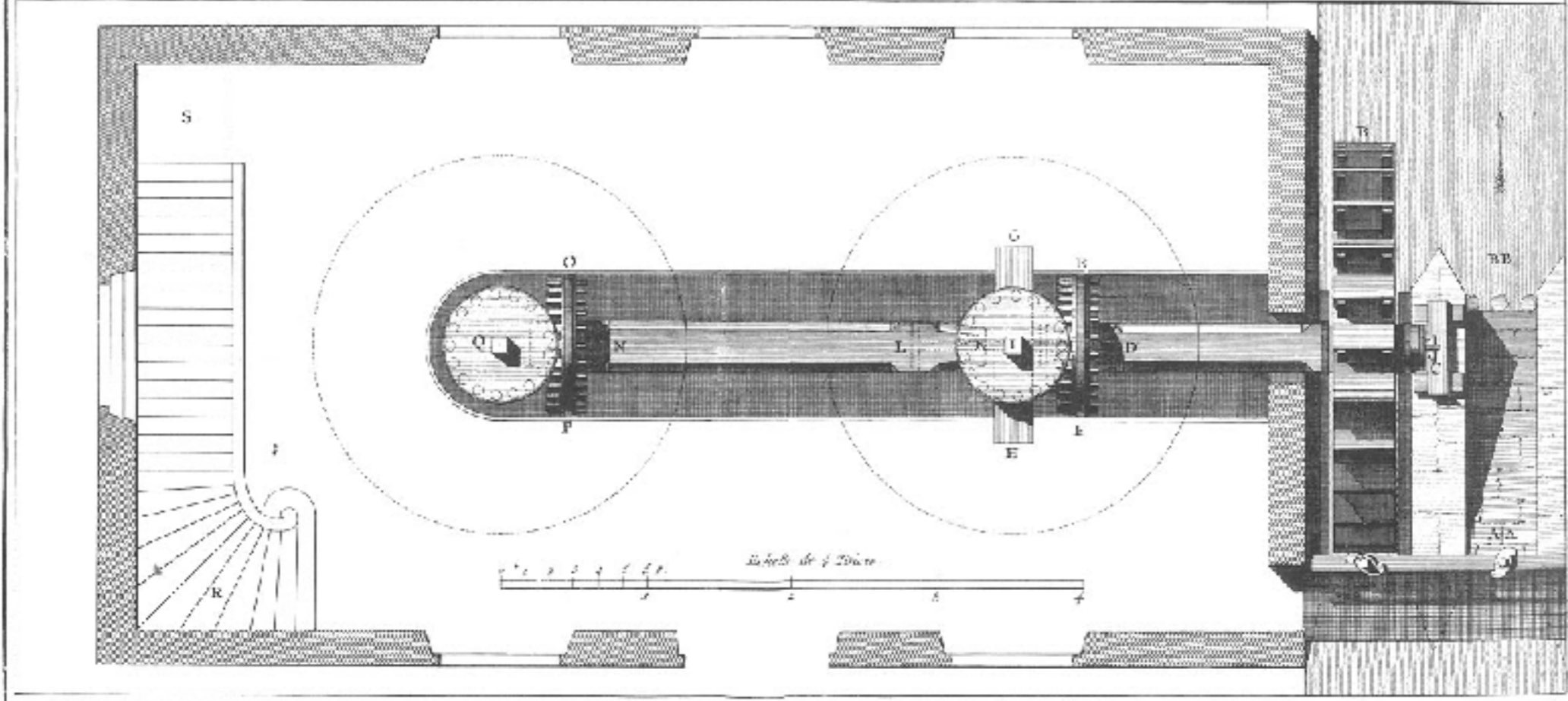
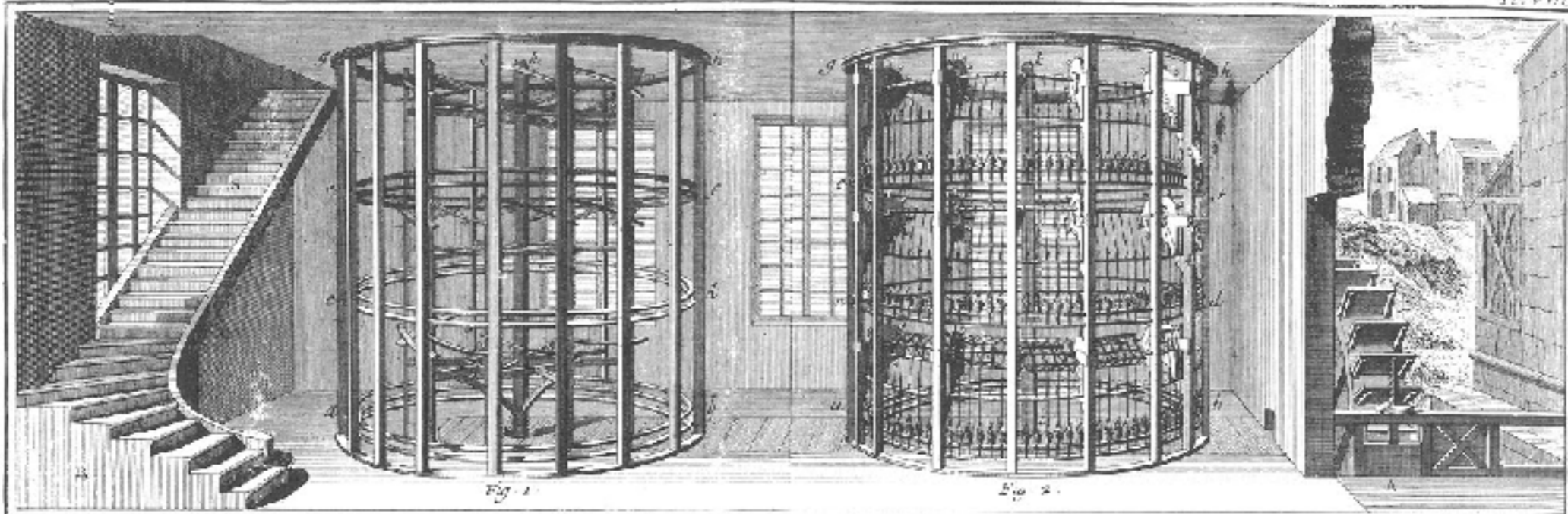

Soierie, Moulin de Piedmont en Perspective, et Plan de la Mécanique au-dessous du Rez de Chaussée. F

“Soierie, ...”  
 The Encyclopedia of Diderot & d'Alembert 1763  
 (University of Michigan)

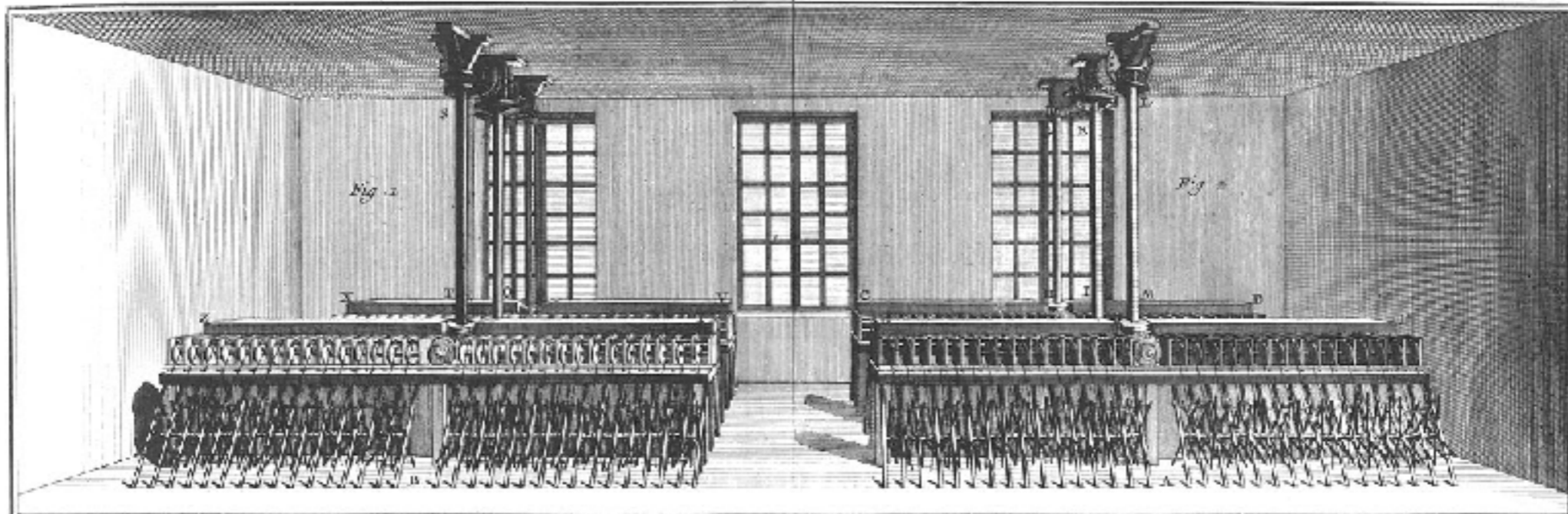
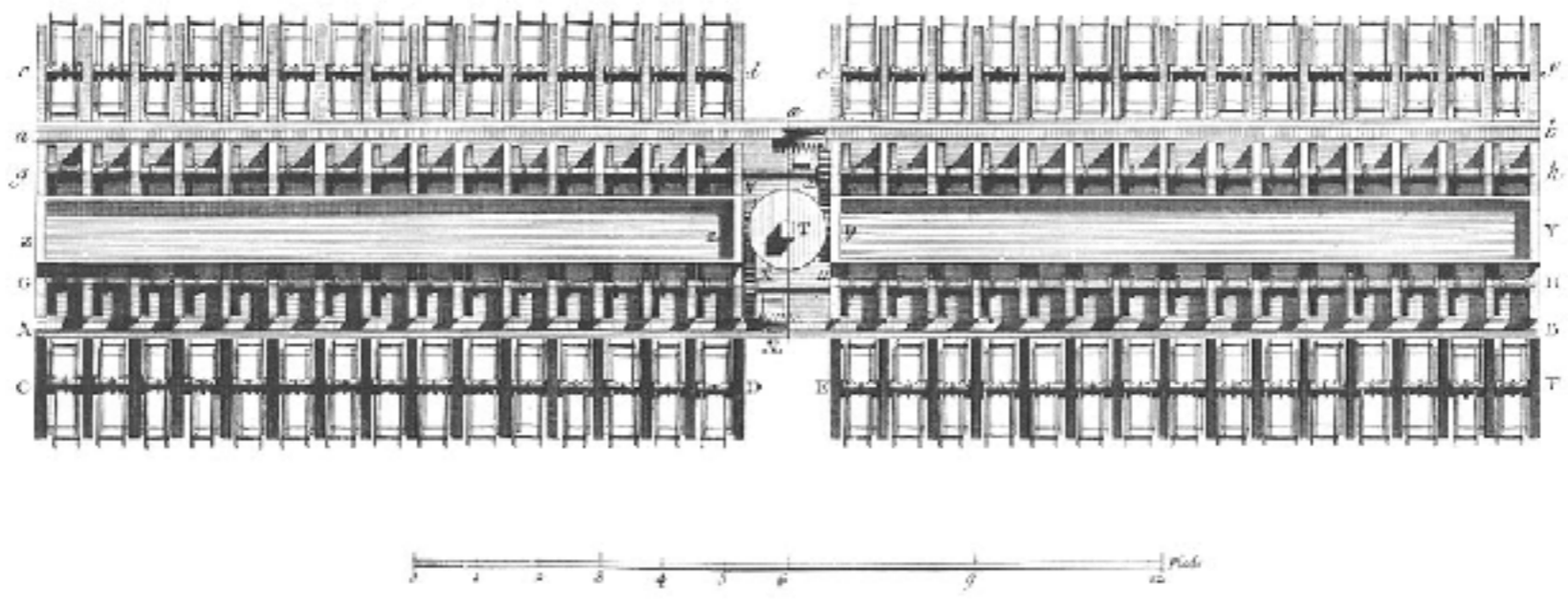

Fig. 3



Del. J. B. LeRoi

Sculp. J. B. LeRoi

Soierie, Elevation perspective d'un grand Dévidage placé au dessus des Moulins représentés cy devant

I

“Soierie, ...”  
 The Encyclopedia of Diderot & d'Alembert 1763  
 (University of Michigan)

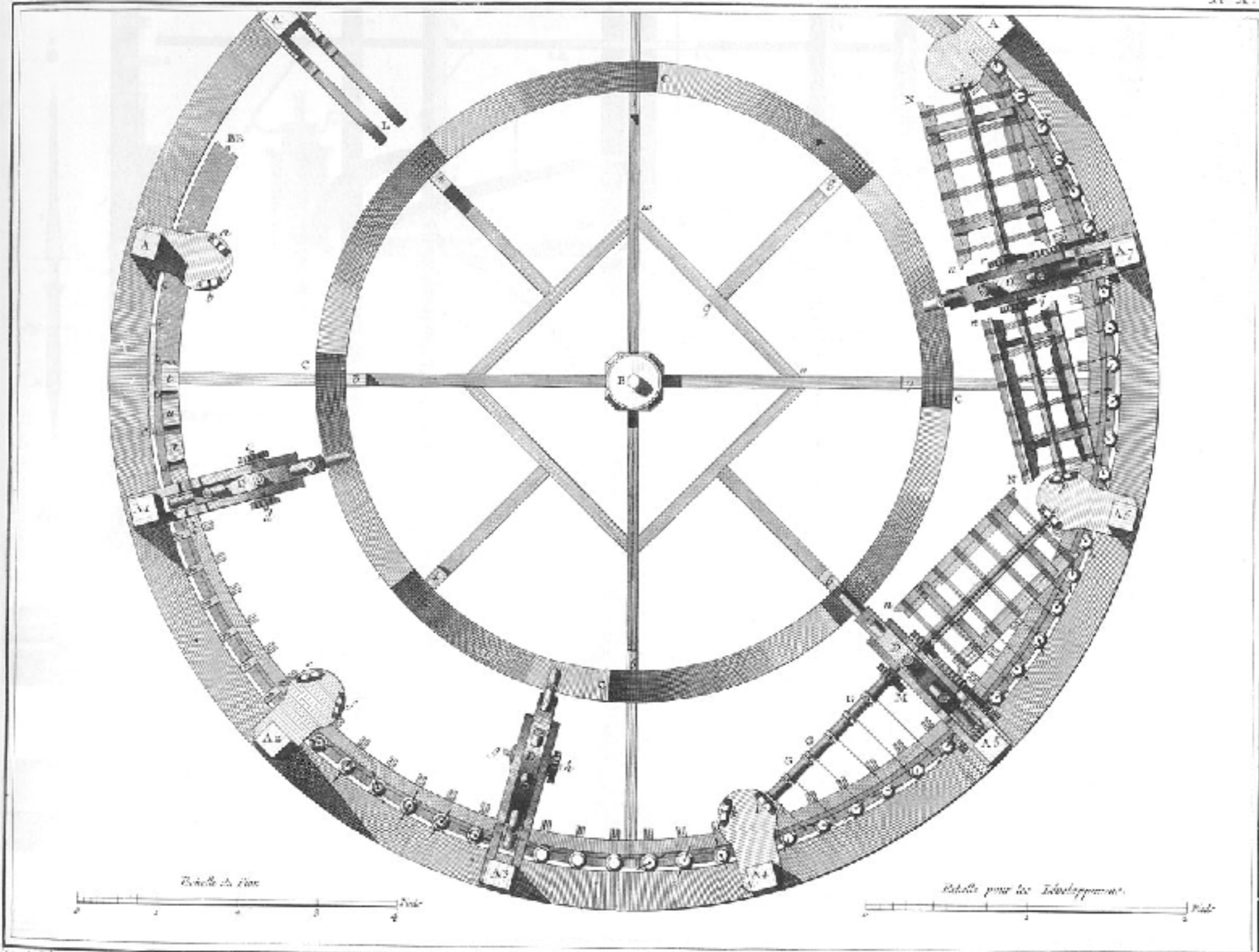

*Soierie, Plan du Moulin de Piémont, à Strafine pour Organiser les Soies.*

*Robert Feut.*

“Soierie, ...”

The Encyclopedia of Diderot & d'Alembert 1763  
(University of Michigan)

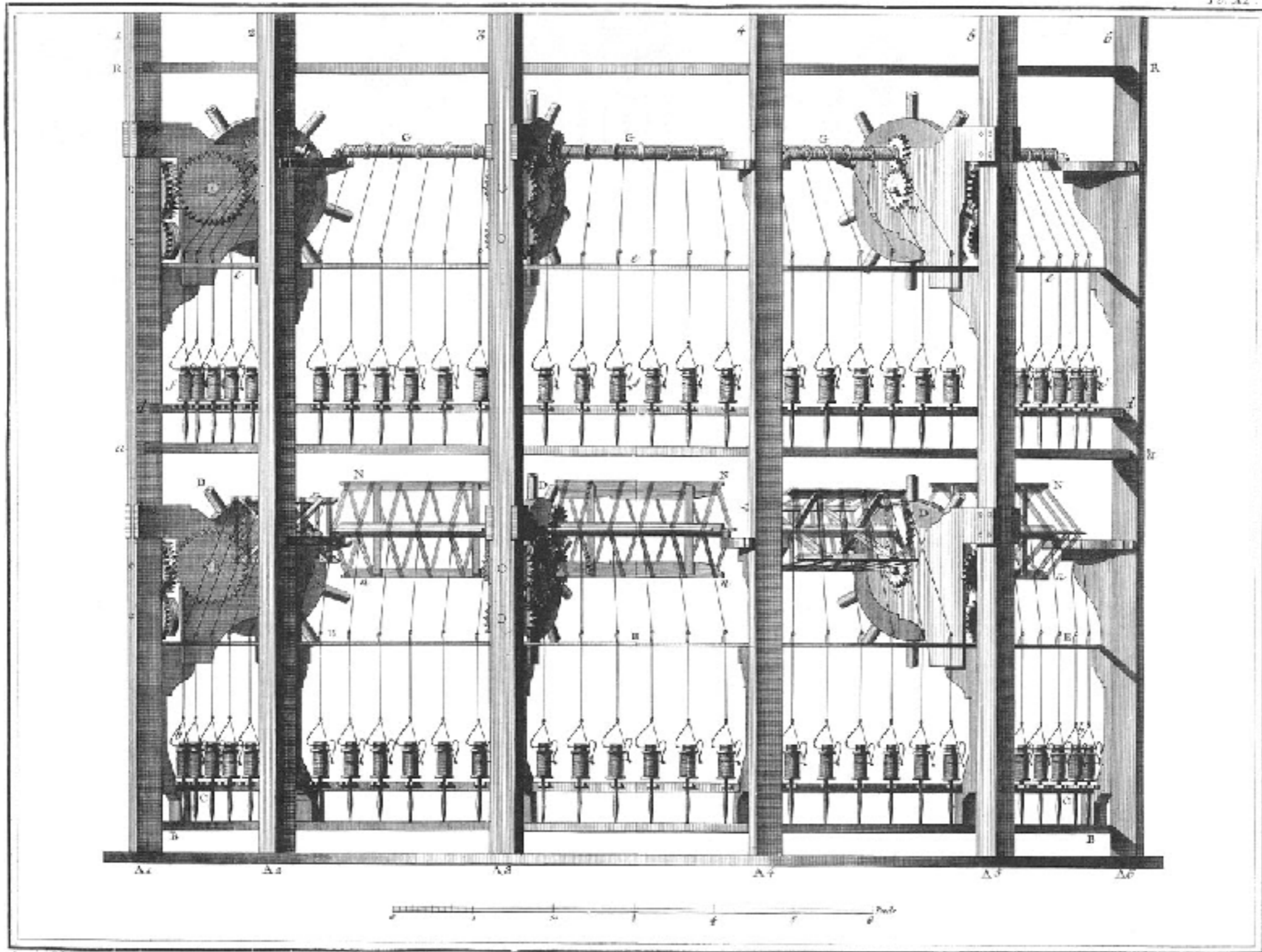

*Soierie, Elevation Géométrale du Moulin de Prémont, pour Organiser les Soies.*

L.

“Soierie, ...”

The Encyclopedia of Diderot & d'Alembert 1763  
(University of Michigan)

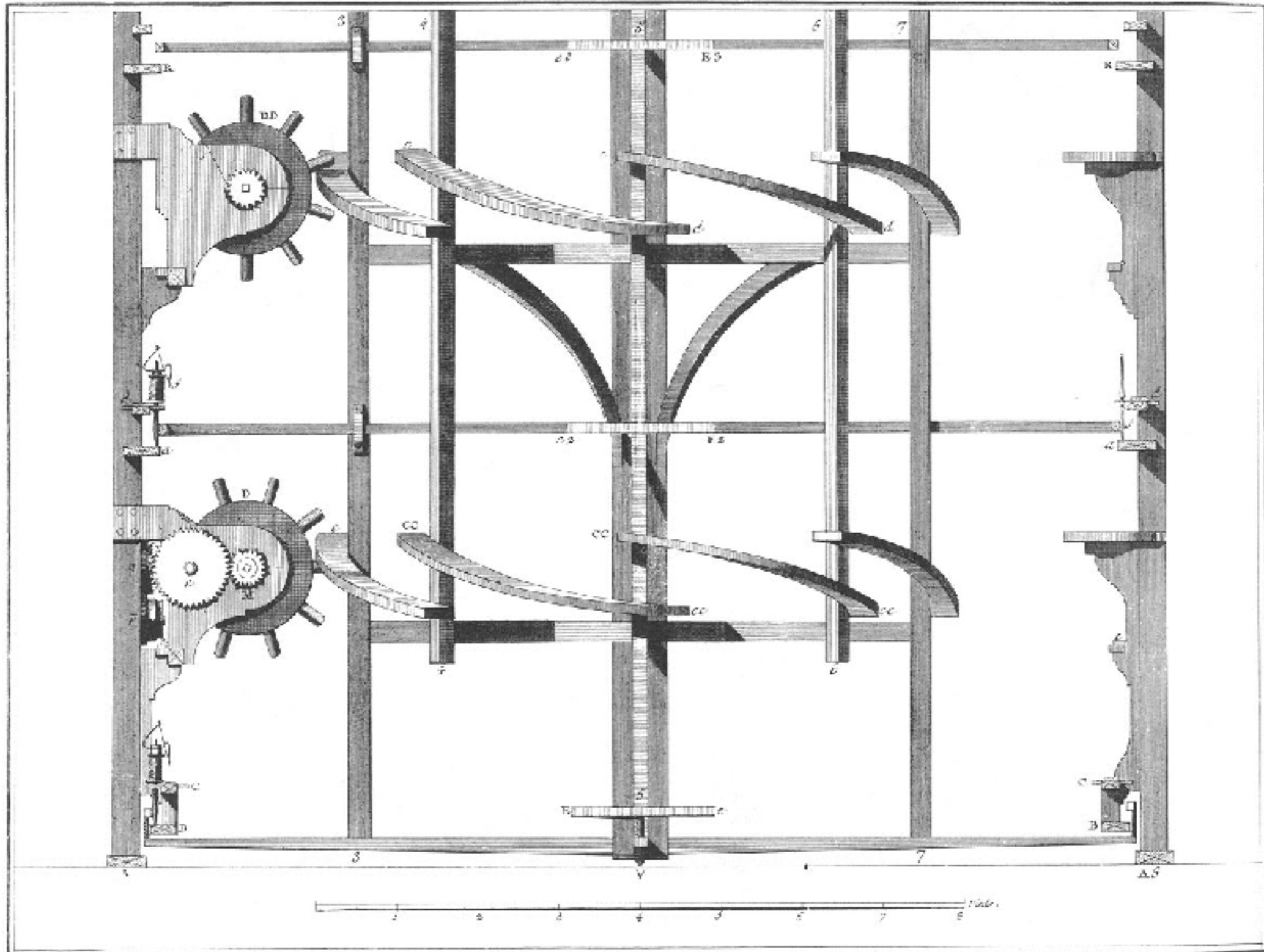

*Soierie, Coupe Diamétrale du Moulin de Fismont et Élévation de la Lanterne qui est dans l'Intérieur.*

M

“Soierie, ...”

The Encyclopedia of Diderot & d'Alembert 1763  
 (University of Michigan)

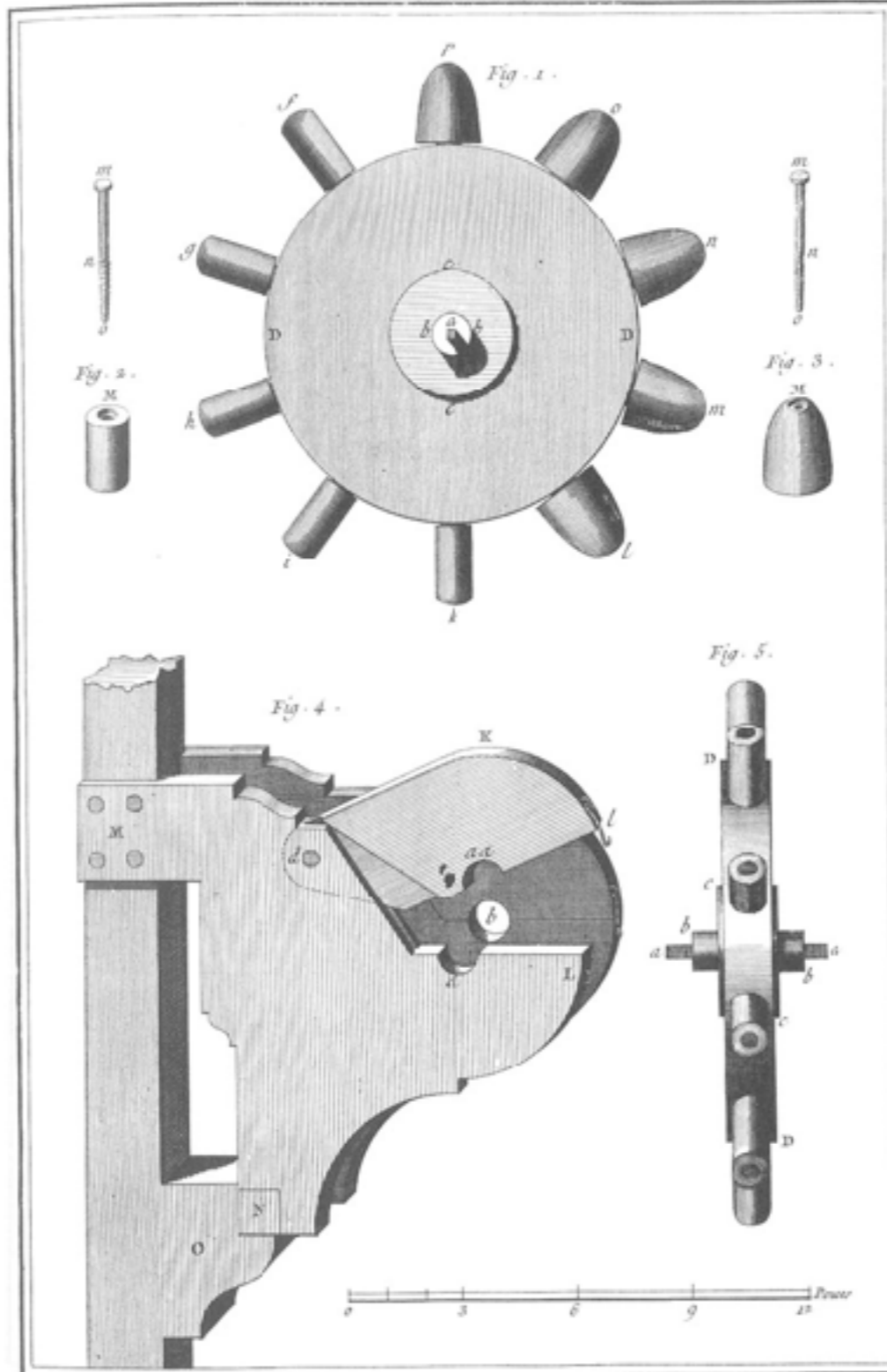

Benard Del.

Benard Sculp.

*Soierie, Moulin de Piémont pour Organiser les Soies, Construction et Développement des Ponçonelles.*

“Soierie, ...”

The Encyclopedia of Diderot & d'Alembert 1763  
 (University of Michigan)

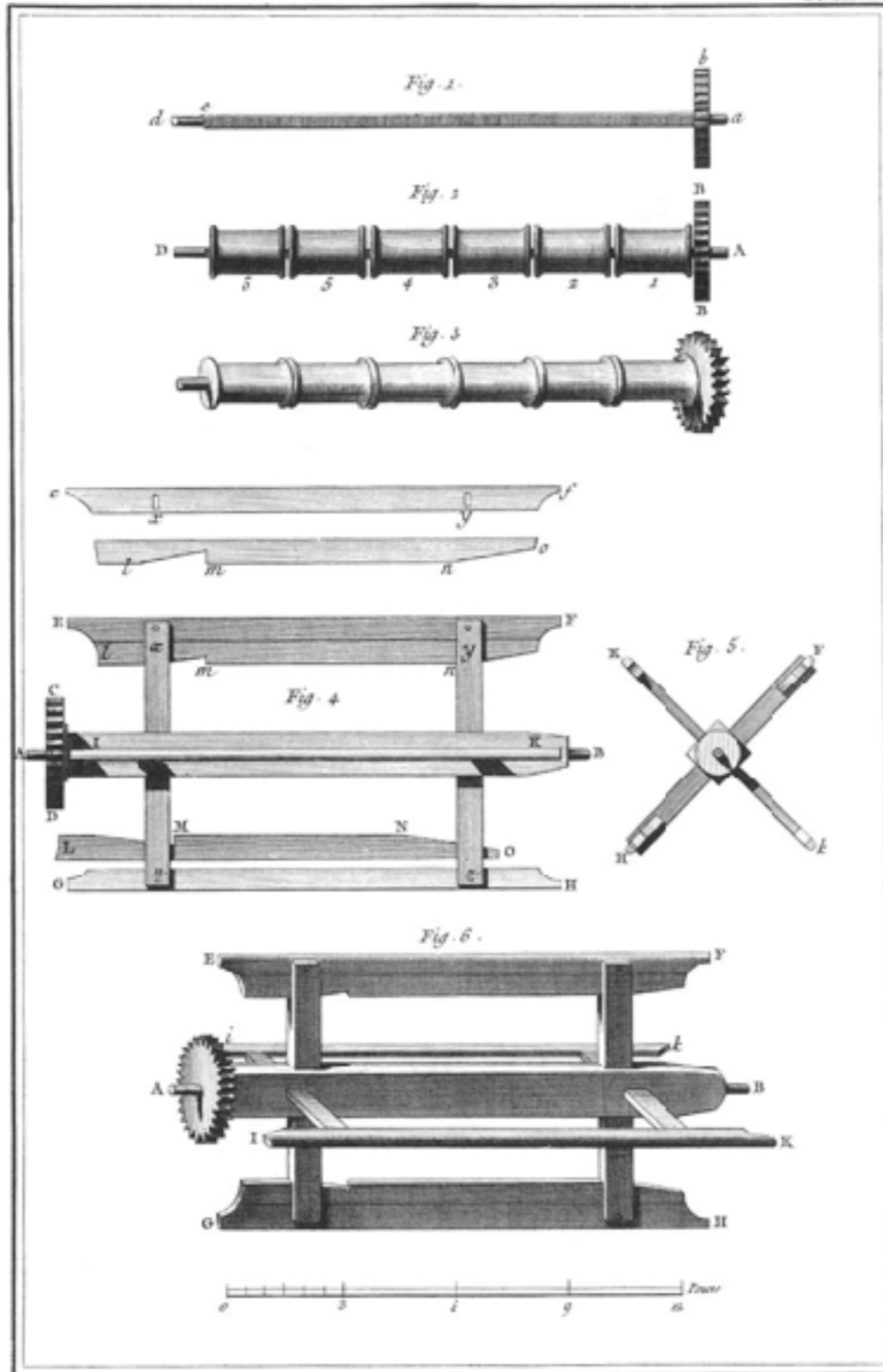

*Soierie, Modin pour Organiser les Soies Construction et Développement -> O  
des Asples ->*

“Soierie, ...”

The Encyclopedia of Diderot & d'Alembert 1763  
(University of Michigan)

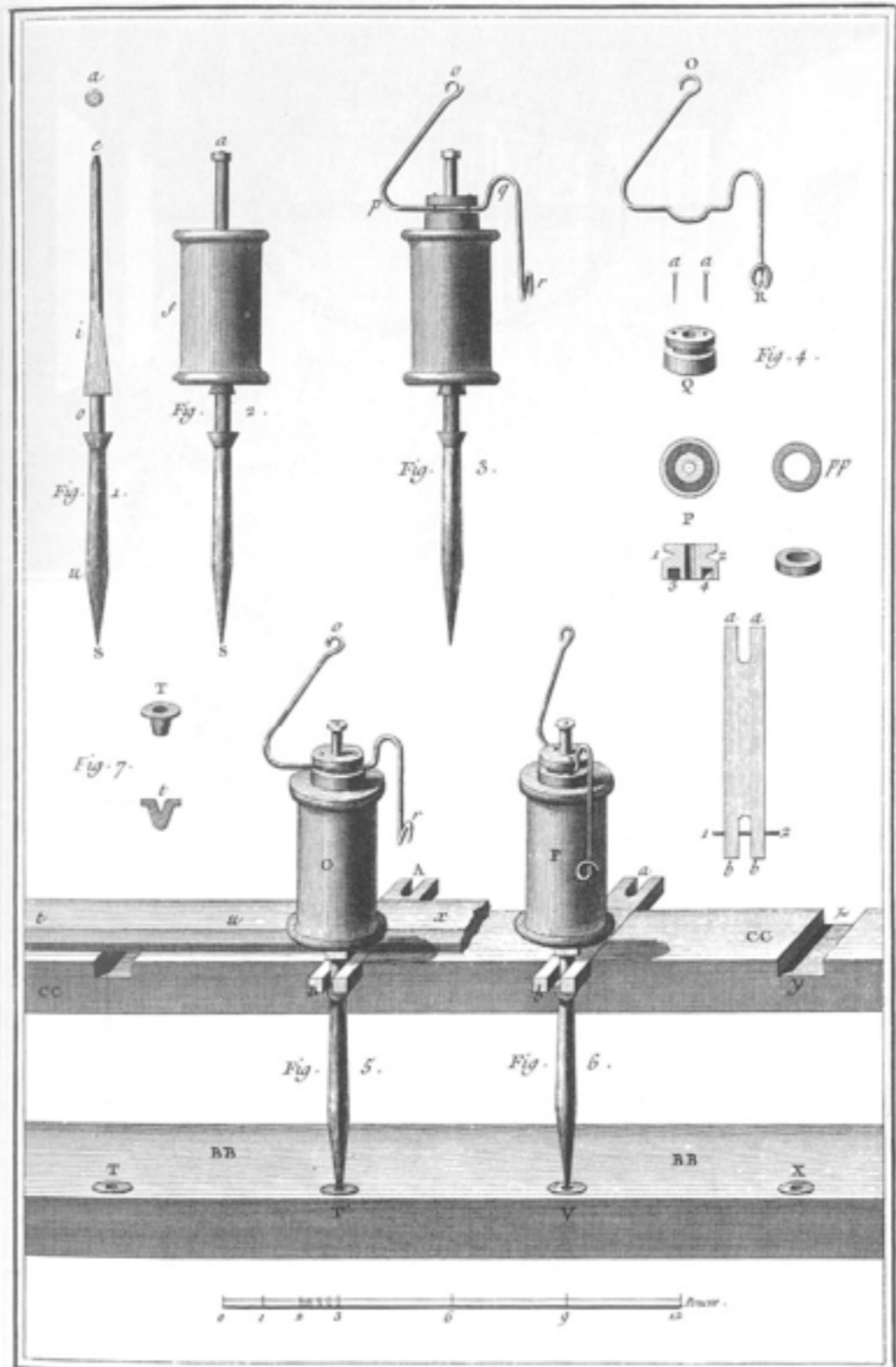

Soierie, Moulin pour Organiser les Soies, Construction et Développement des Fusées. P

“Soierie, ...”  
 The Encyclopedia of Diderot & d'Alembert 1763  
 (University of Michigan)

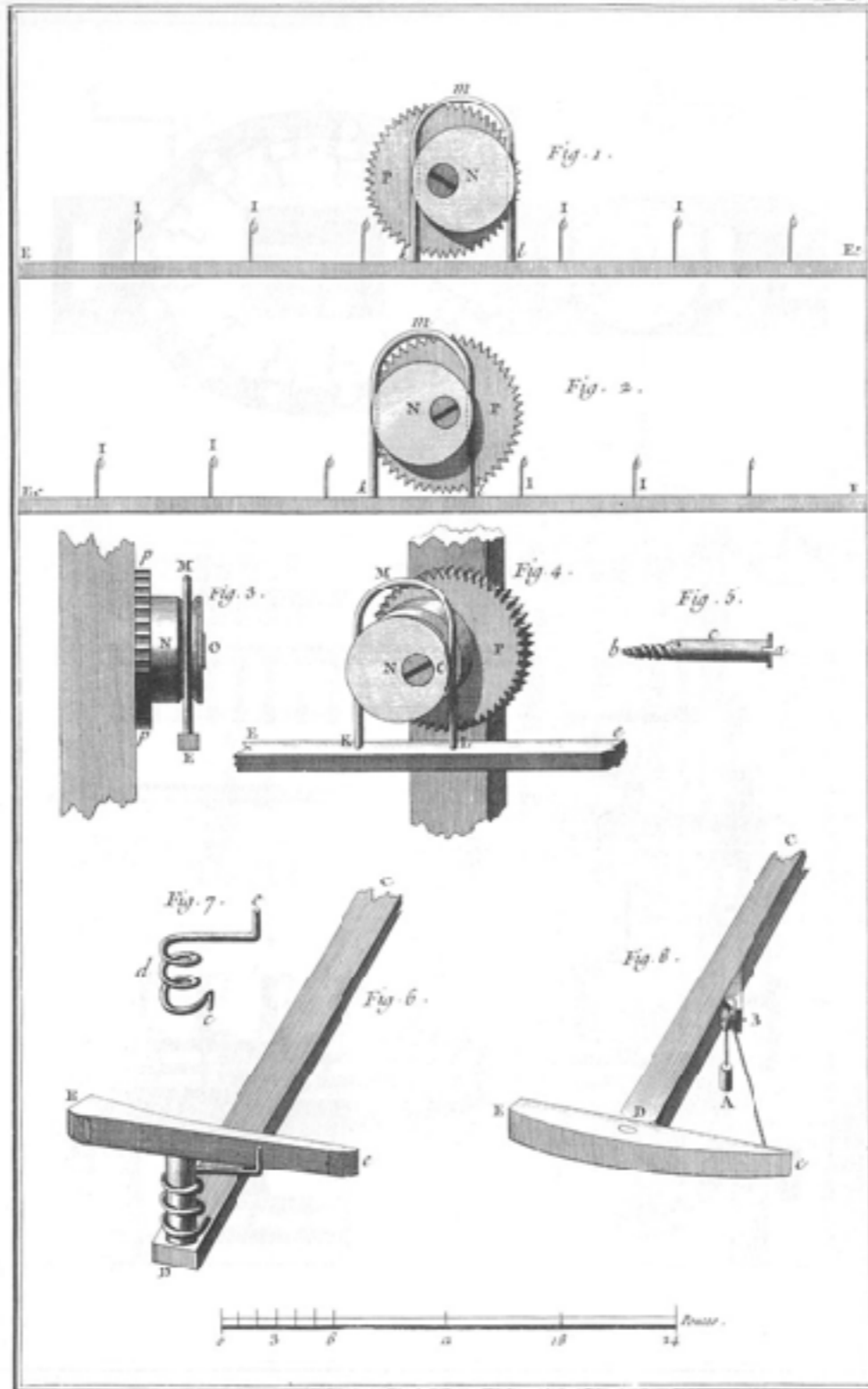

*Soierie, Moulin pour Organsiner les Soies, Développement du Fâ-à-Vent, et des surfiles.*

“Soierie, ...”

The Encyclopedia of Diderot & d'Alembert 1763  
(University of Michigan)

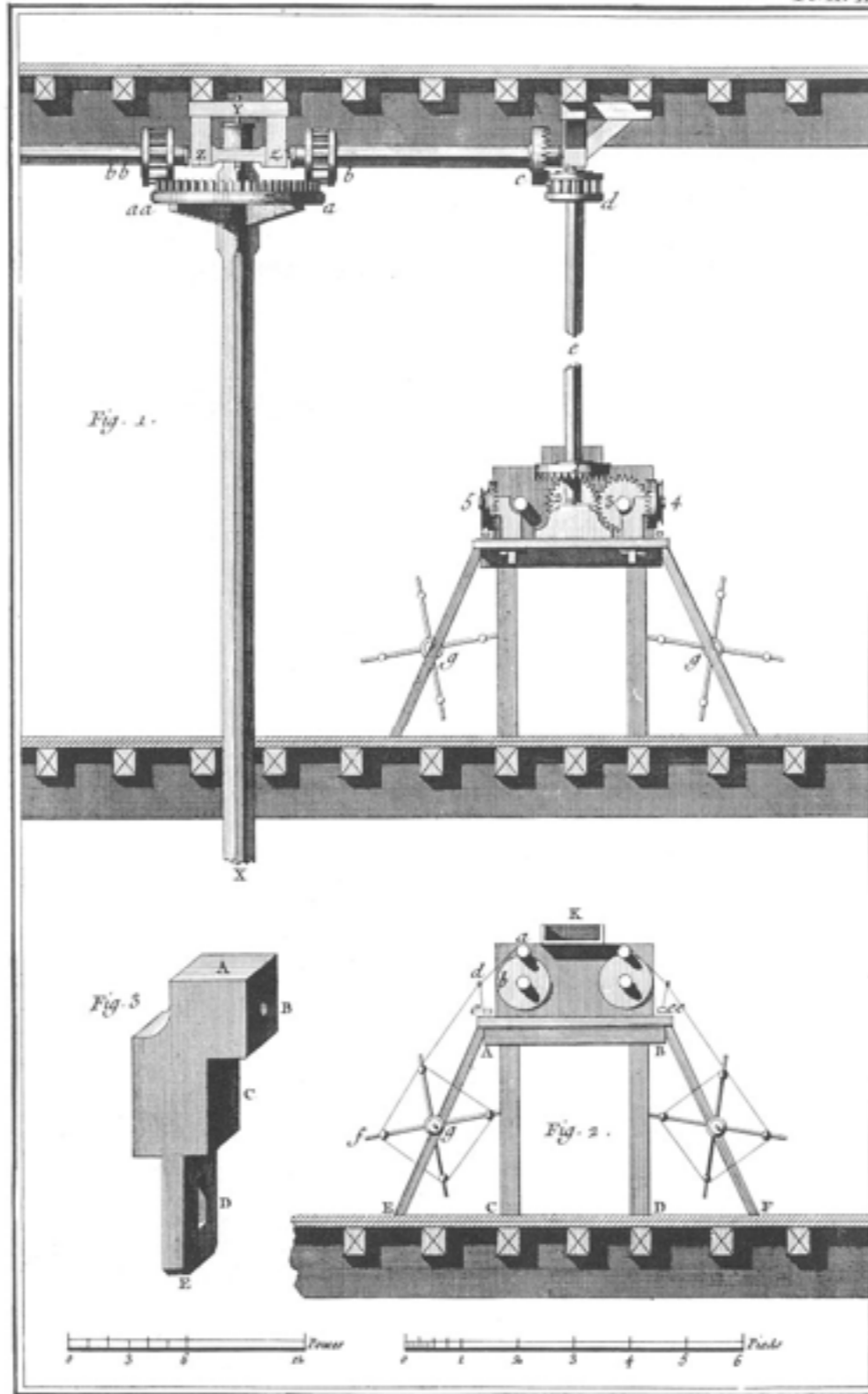

Guarner Del.

Benard Scul.

Soierie, Profile du Devidage qui est au dessus des Moulins à Organiser les Soies. R

“Soierie, ...”

The Encyclopedia of Diderot & d'Alembert 1763  
(University of Michigan)

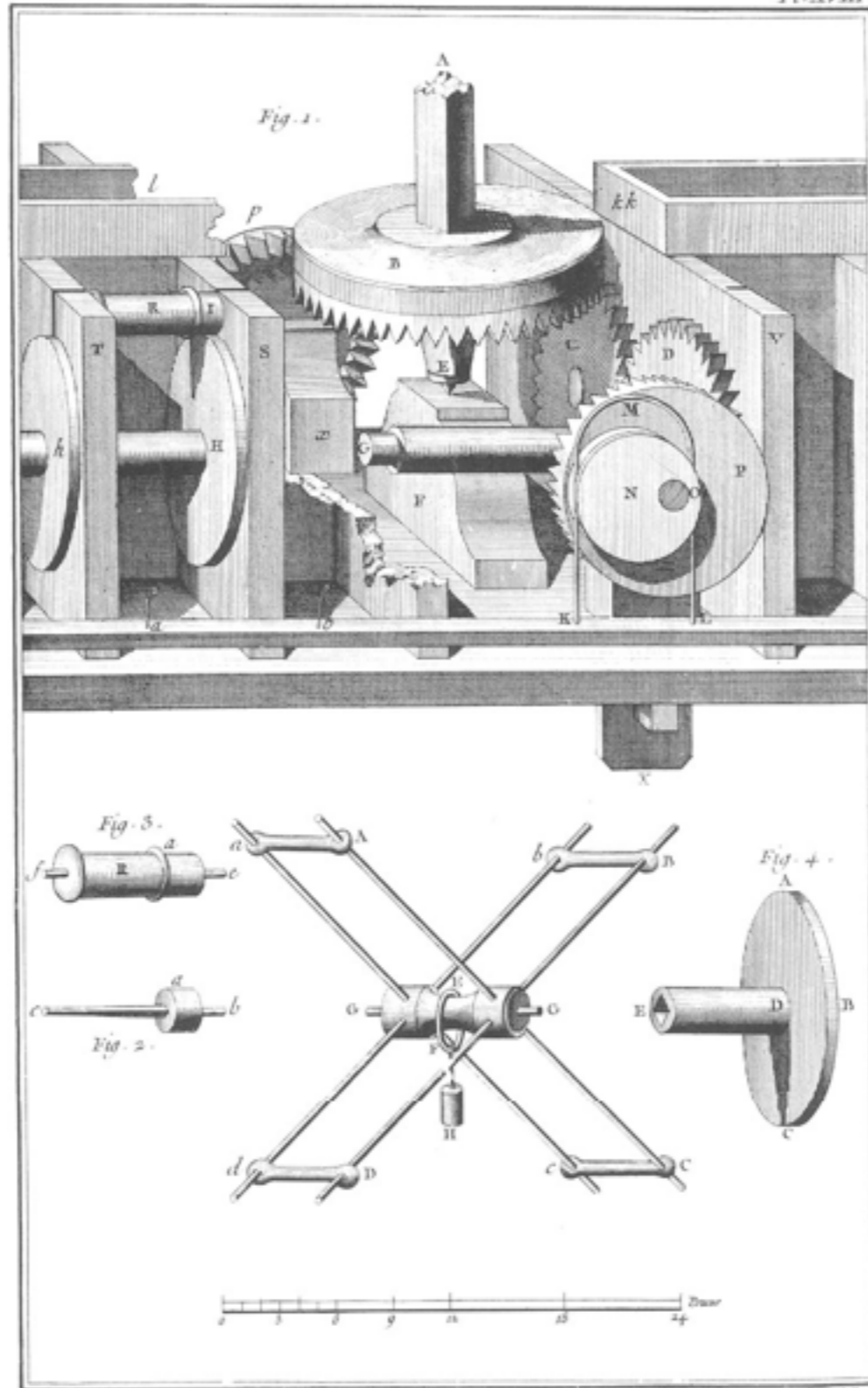

Soierie, Développement du Va - et - Vient du Devidage &c. S

“Soierie, ...”

The Encyclopedia of Diderot & d'Alembert 1763  
(University of Michigan)

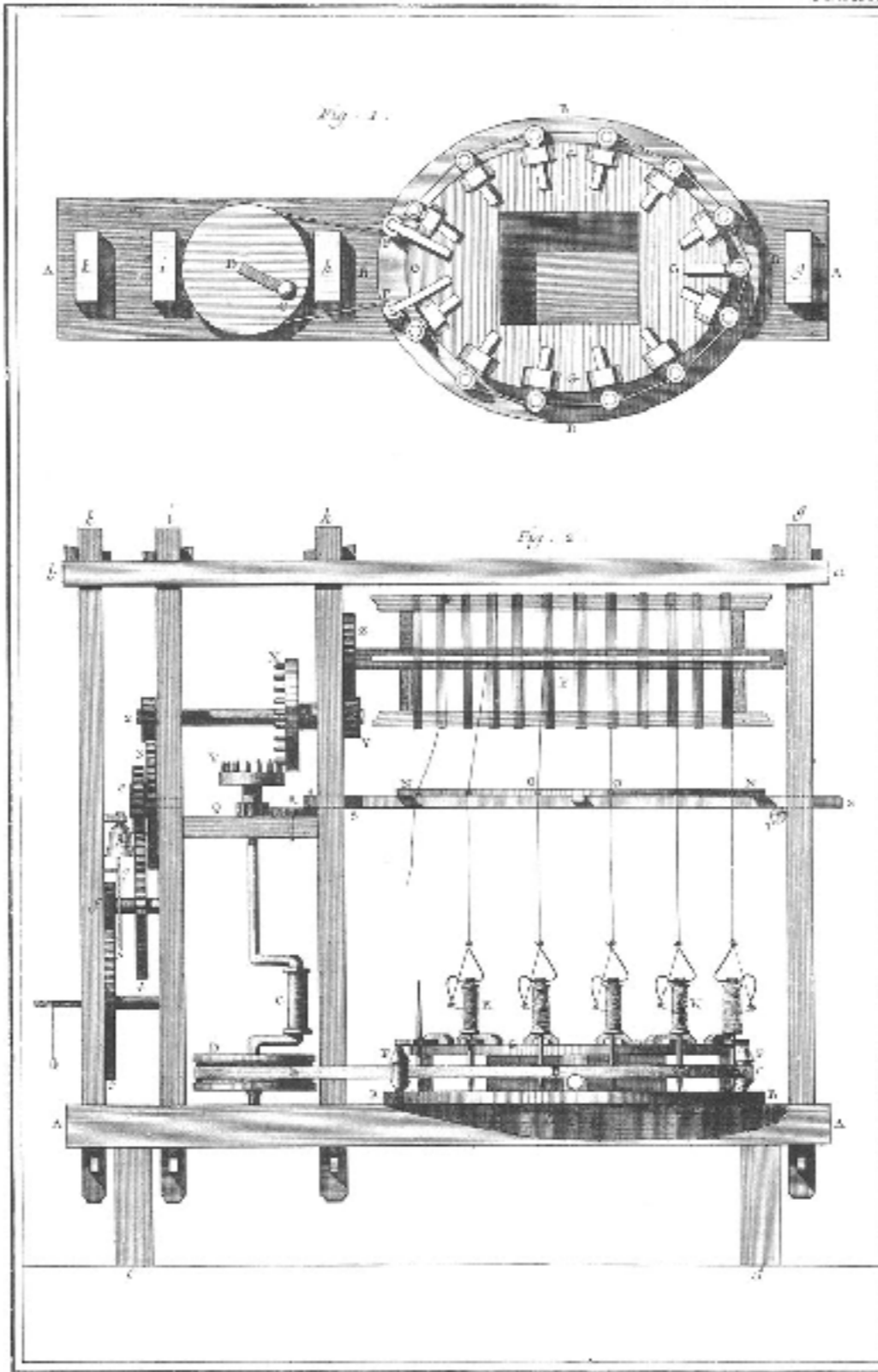

*Soierie, Ovale Plan et Elevation.*

T

“Soierie, ...”

The Encyclopedia of Diderot & d'Alembert 1763  
(University of Michigan)

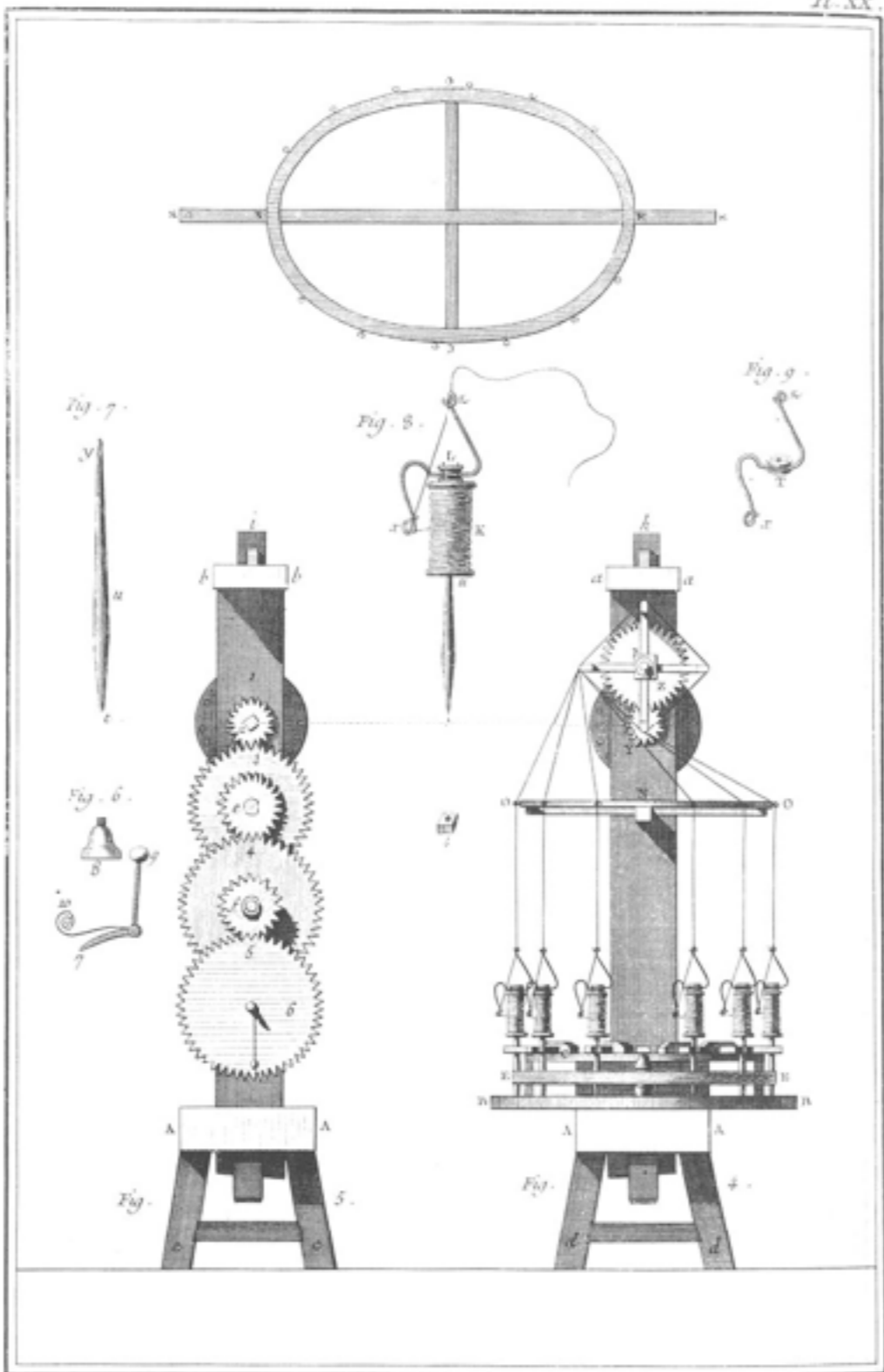

Wouvier del.

Beard fecit.

Soierie; Ovale, Coupes Transversalles et Developpemens de plusieurs Parties.

V

“Soierie, ...”

The Encyclopedia of Diderot & d'Alembert 1763 (University of Michigan)

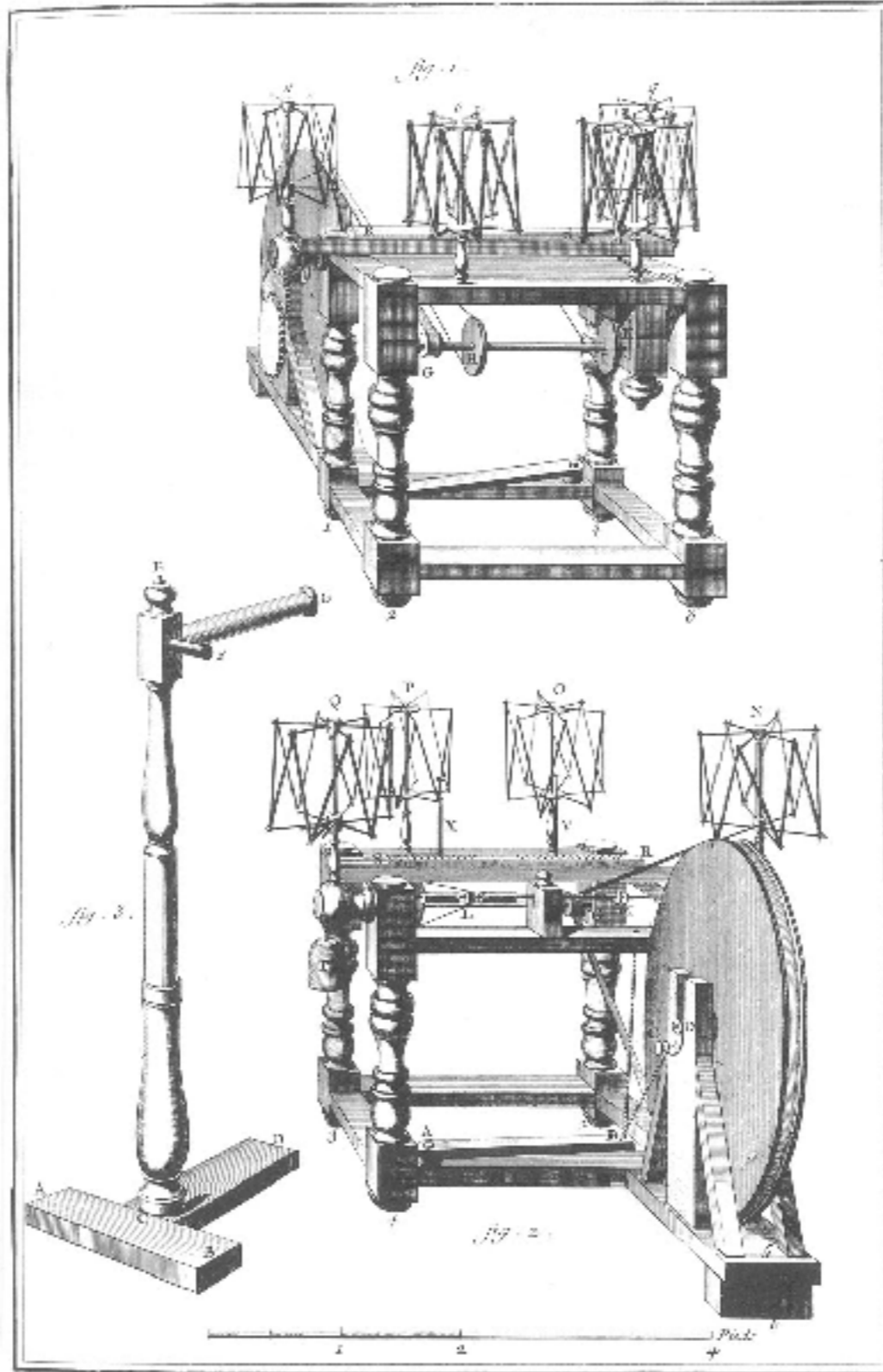

*Soierie, Rouet de Lion en Perspective vu des deux côtés. X*

“Soierie, ...”

The Encyclopedia of Diderot & d'Alembert 1763  
(University of Michigan)

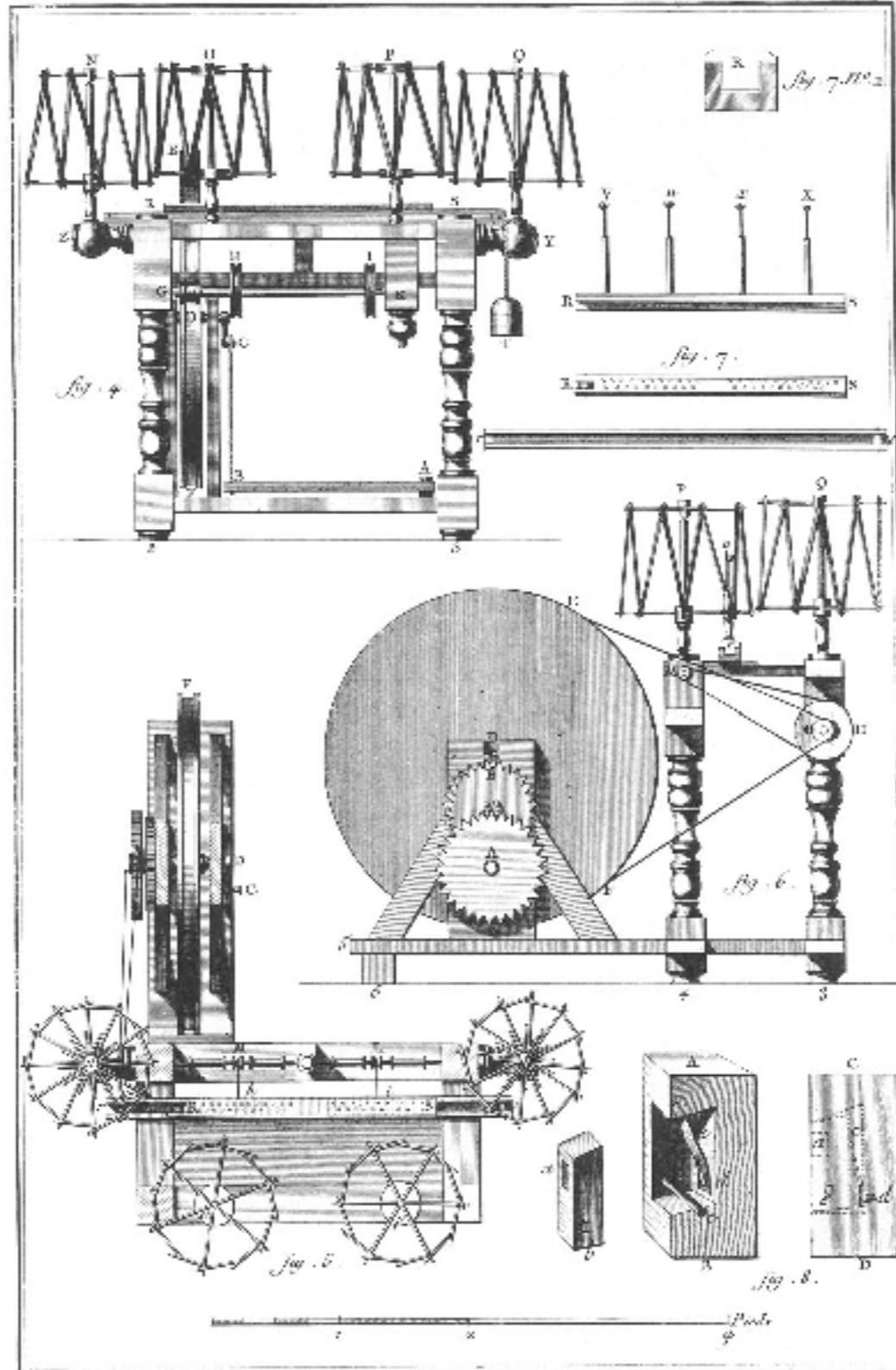

Soierie, Rouet de Lion, Développemens. Y

“Soierie, ...”  
The Encyclopedia of Diderot & d'Alembert 1763  
(University of Michigan)

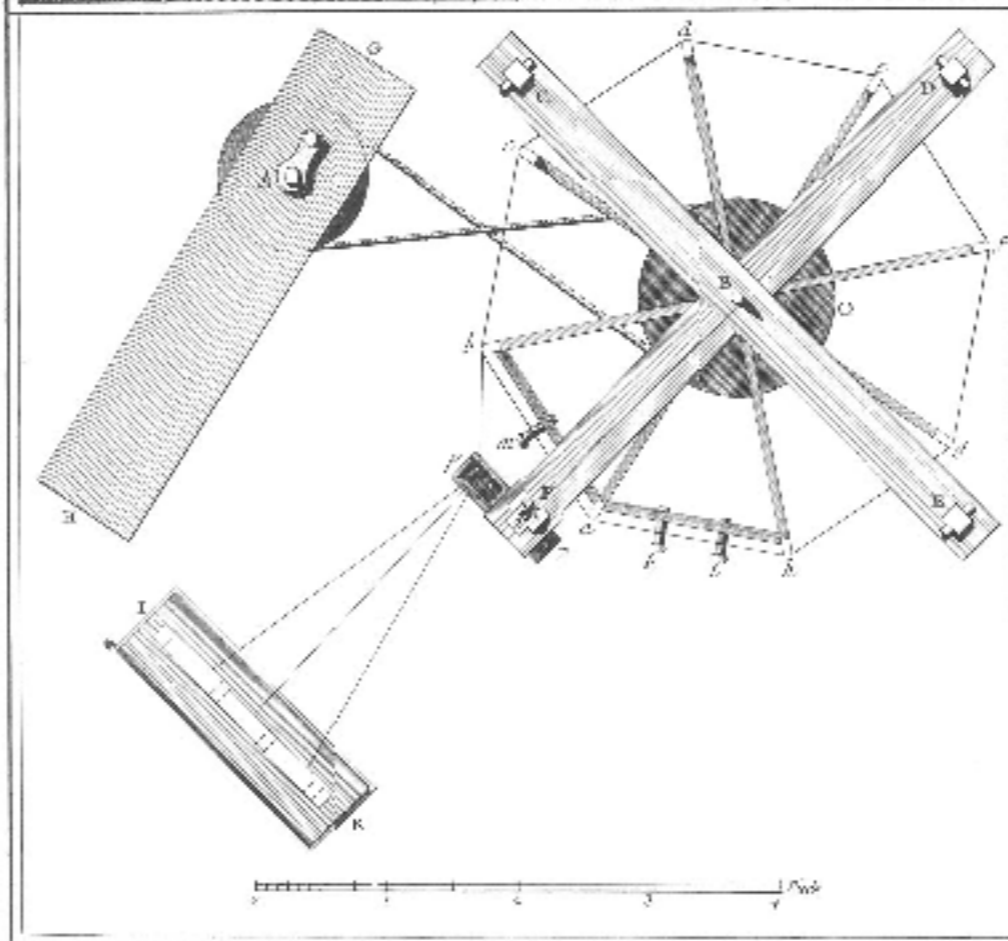
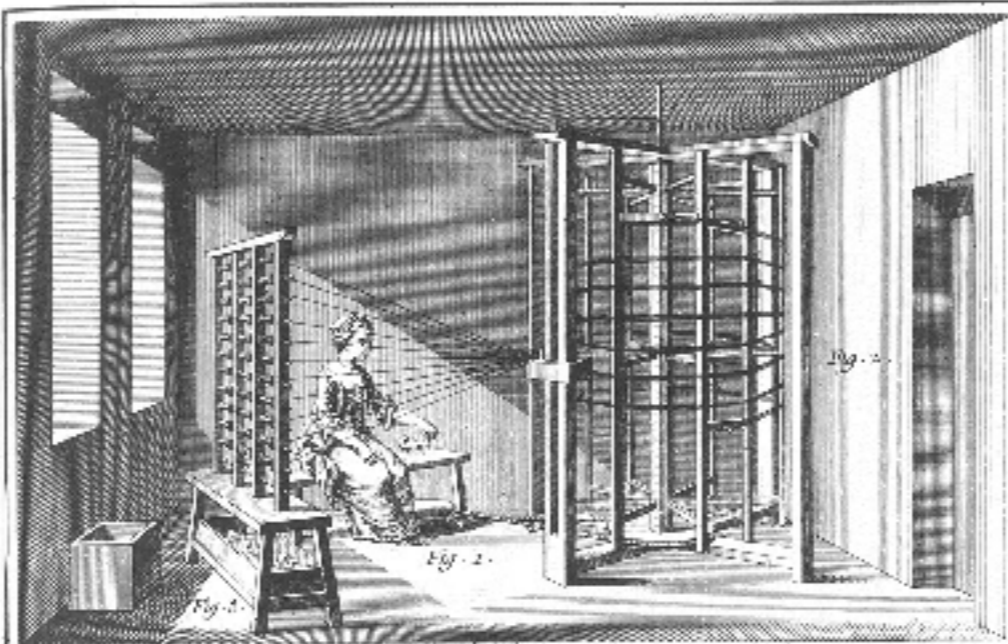

Soierie, l'opération d'ourdier la chaîne des litesffes. 2.

“Soierie, ...”

The Encyclopedia of Diderot & d'Alembert 1763  
(University of Michigan)

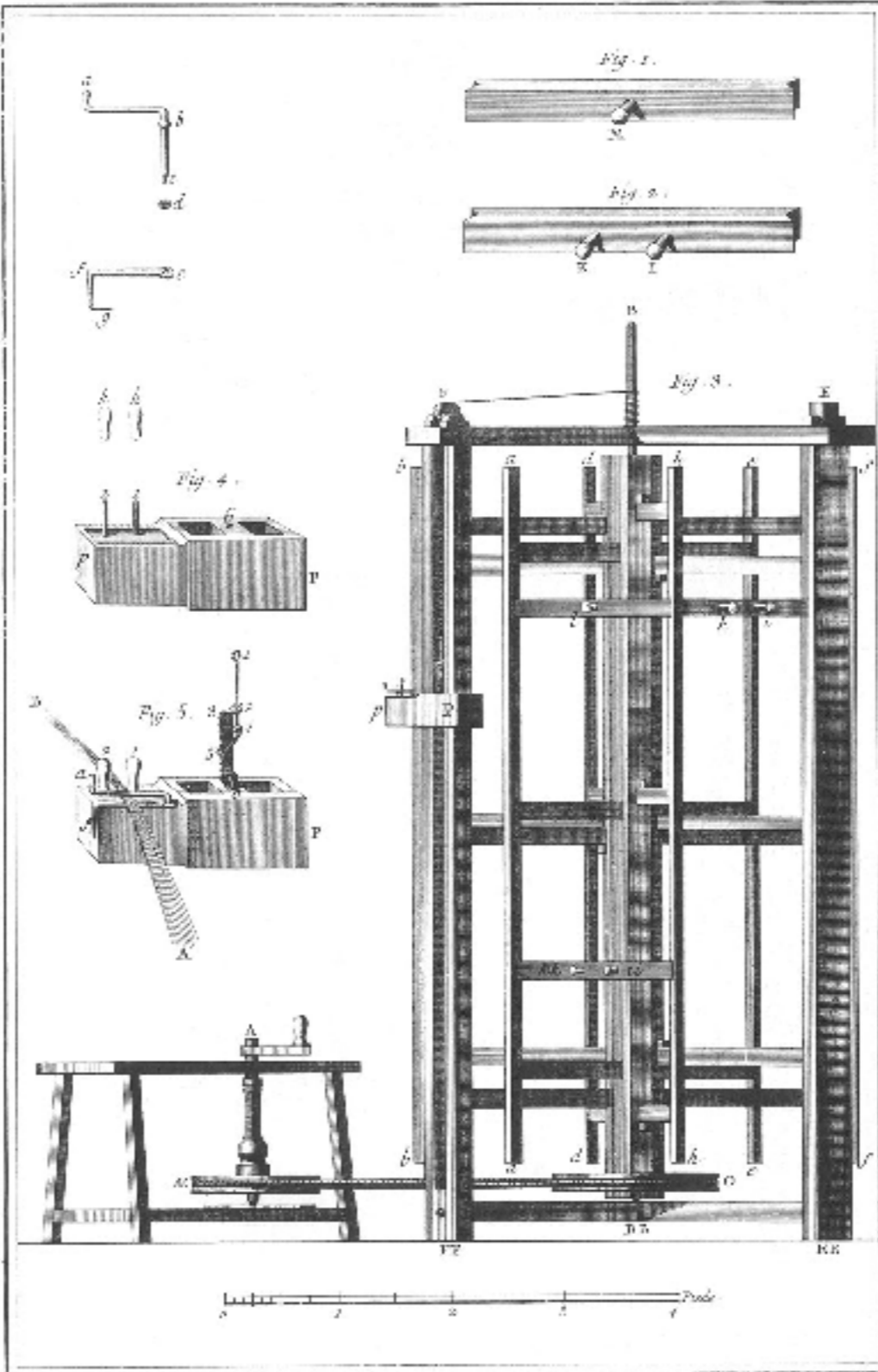

Traverse Del.

Anquet Grav.

*Soierie, Développement de l'ourdissage.*

AA

“Soierie, ...”

The Encyclopedia of Diderot & d'Alembert 1763  
(University of Michigan)

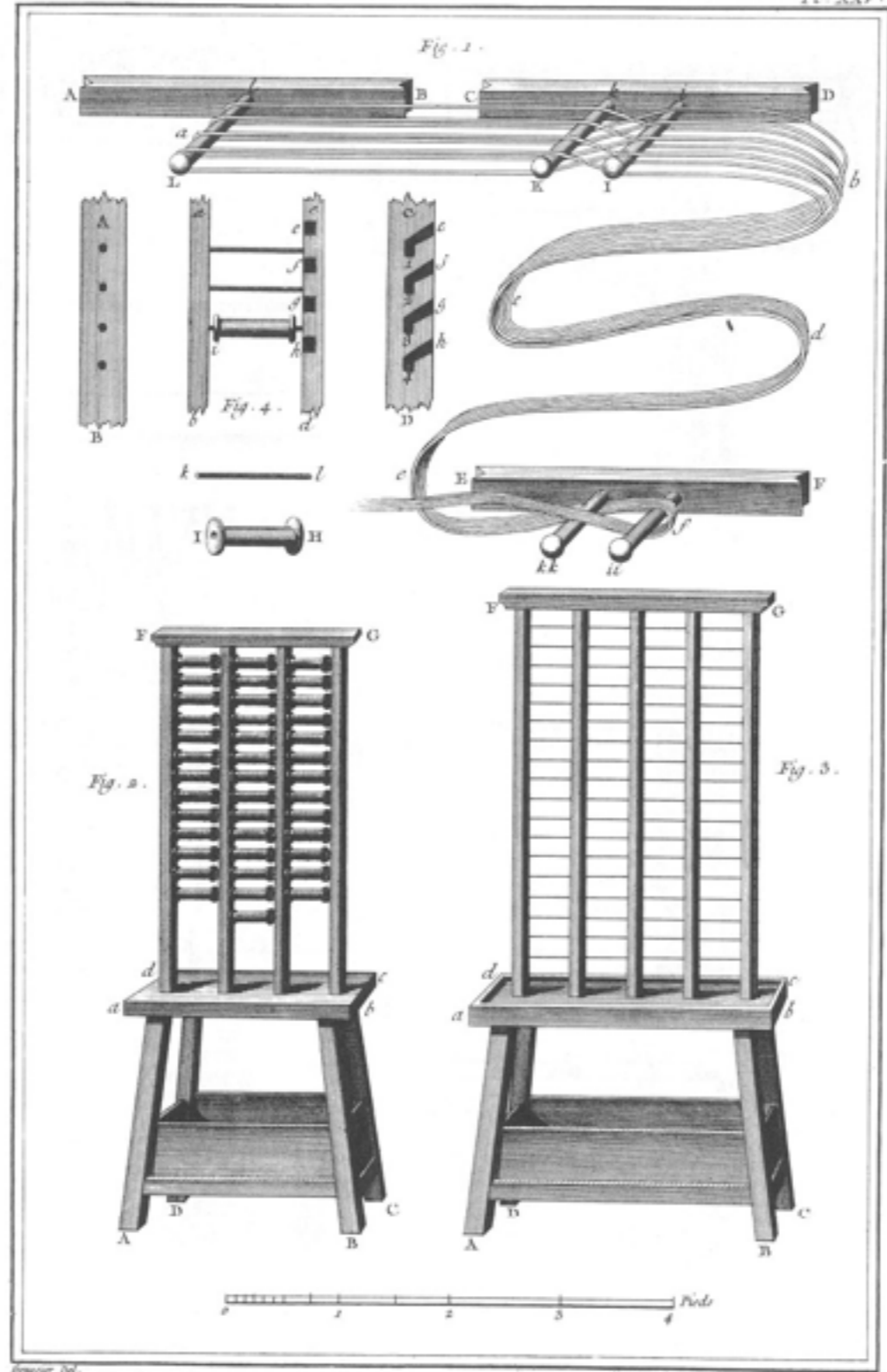

*Soierie, Développement de la Canthre ou Banque et de l'Encroix par Fils et par Portées* B.B

“Soierie, ...”

The Encyclopedia of Diderot & d'Alembert 1763  
(University of Michigan)

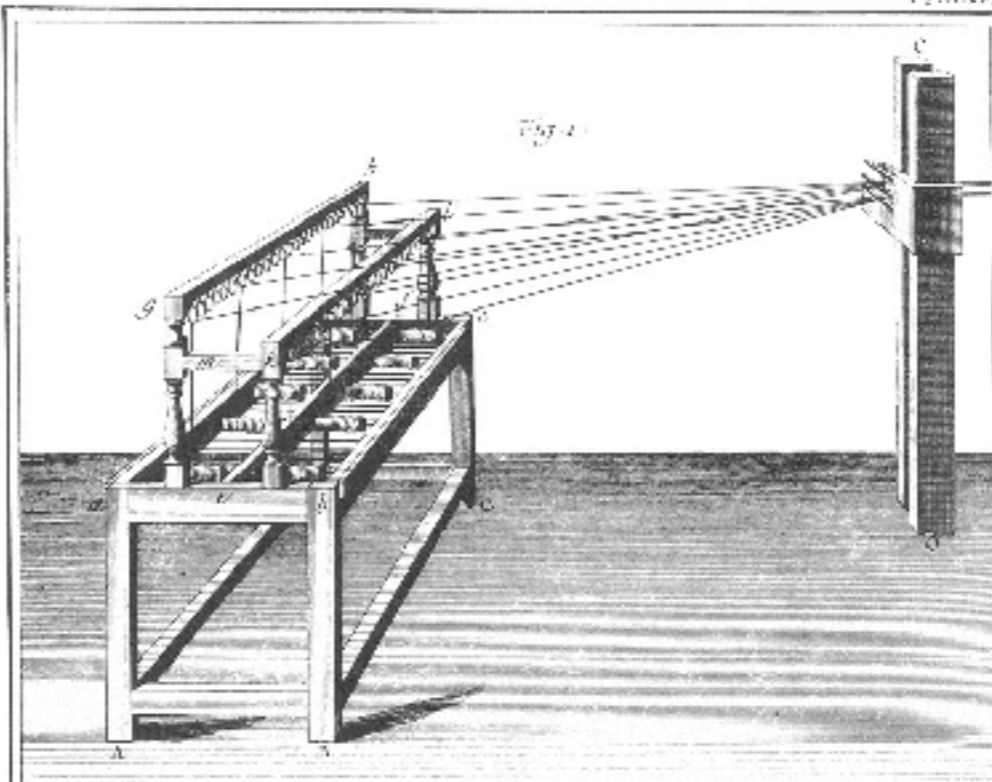
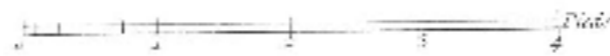
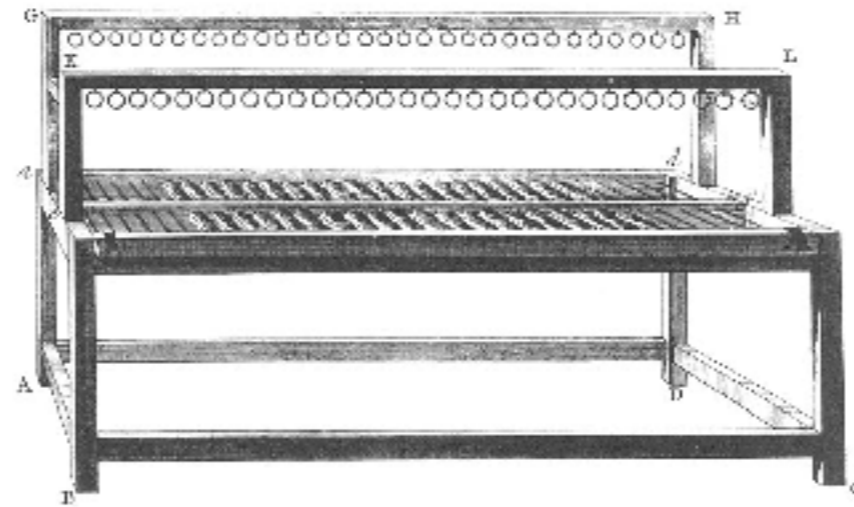

Fig. 2



Benard del.

Benard fecit.

Soierie, centre à la Lilloise. Vue en Perspective.

CC

“Soierie, ...”

The Encyclopedia of Diderot & d'Alembert 1763  
(University of Michigan)

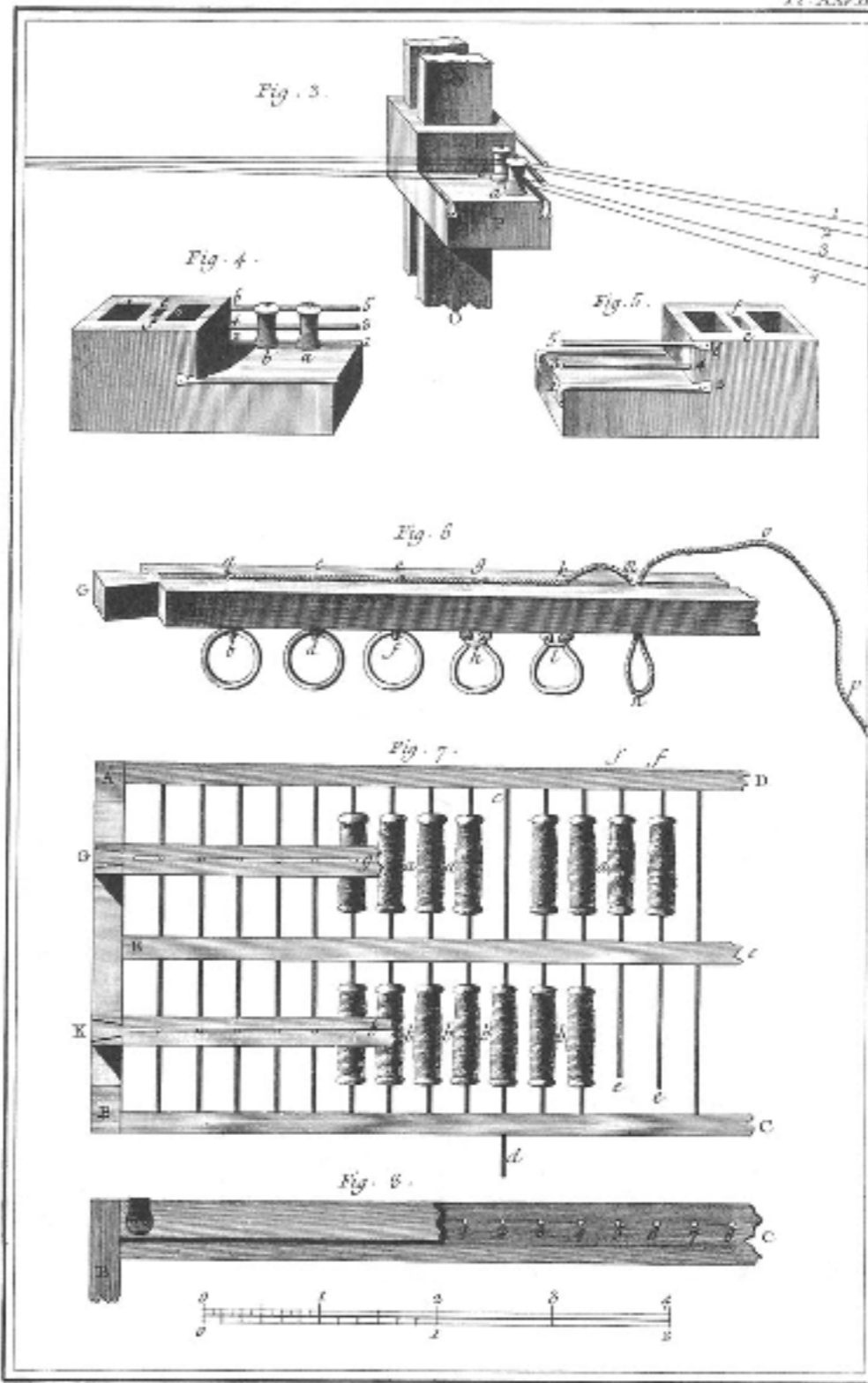

Benard Del. Benard Sculp.

Soierie,

Centre à la Lionnoise; Développemens de la Centre et du Plot à trois triangles. DDD

“Soierie, ...”

The Encyclopedia of Diderot & d'Alembert 1763 (University of Michigan)

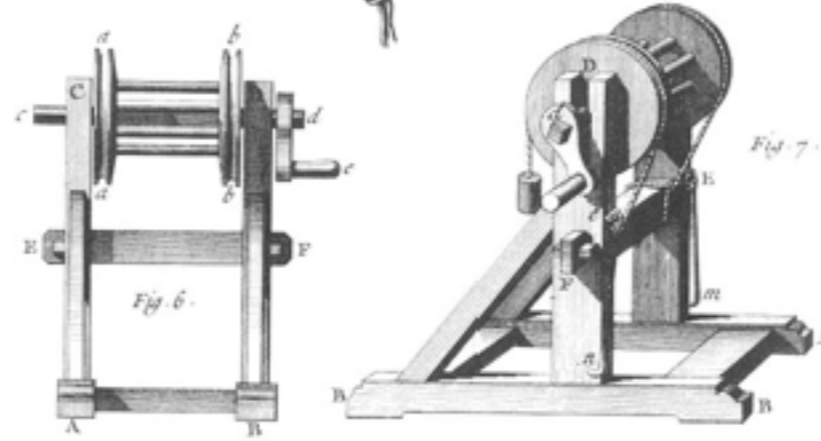
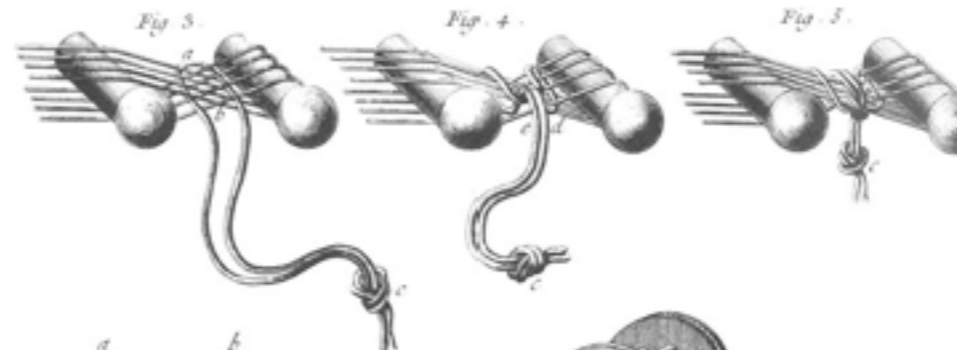
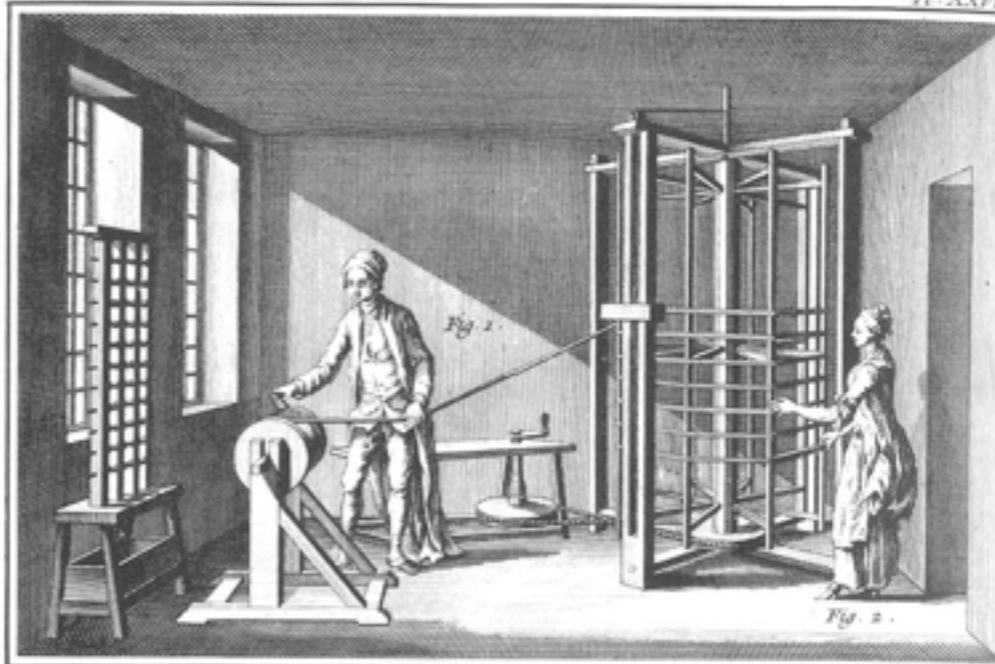

Benard del.

Benard fecit.

Soierie, l'opération de Relever.

E.E.

“Soierie, ...”

The Encyclopedia of Diderot & d'Alembert 1763  
(University of Michigan)

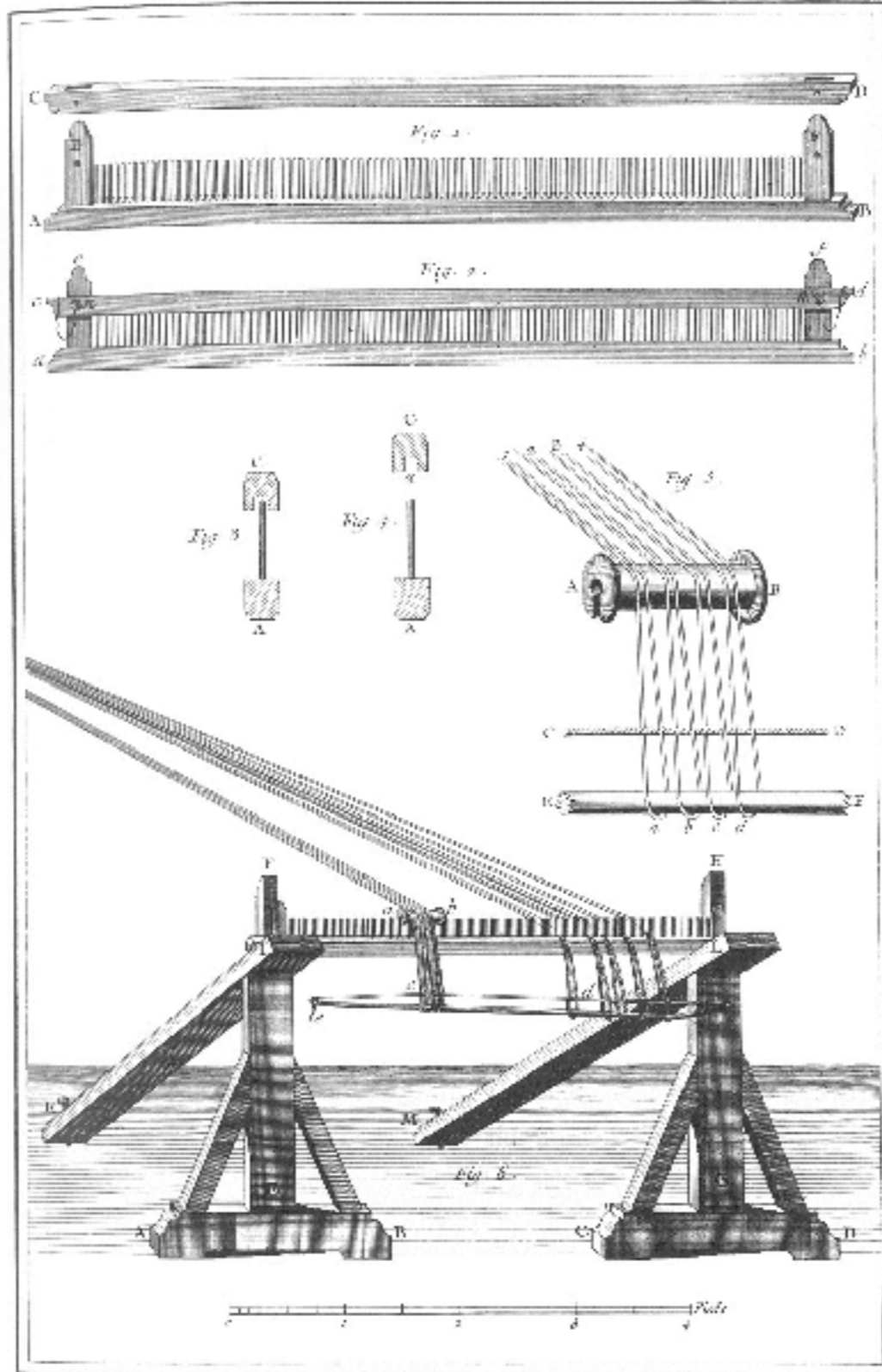

Soierie, l'opération de Ployer et Développement du Ratoum. FF

“Soierie, ...”

The Encyclopedia of Diderot & d'Alembert 1763  
(University of Michigan)

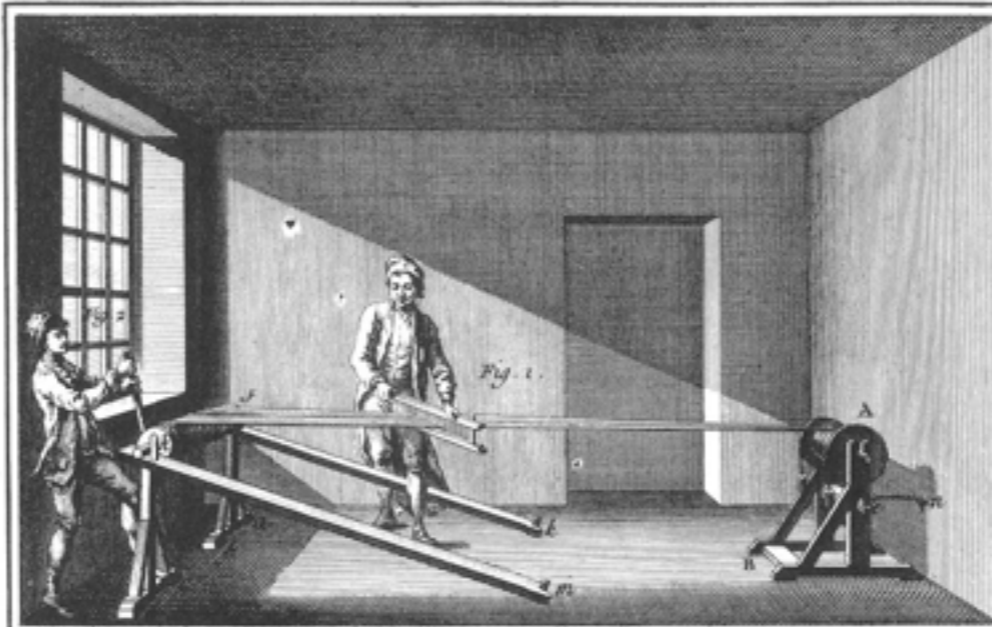

Fig. 3.



Fig. 4.



Fig. 5.

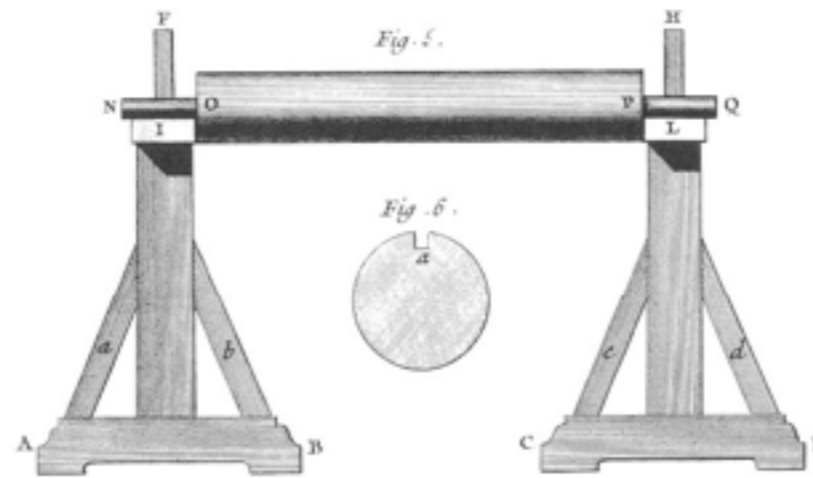
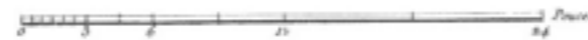

Fig. 6.



Soierie, l'opération de Ployer la Chaîne des Etoffes sur l'Étrépile.

GG

“Soierie, ...”

The Encyclopedia of Diderot & d'Alembert 1763  
(University of Michigan)

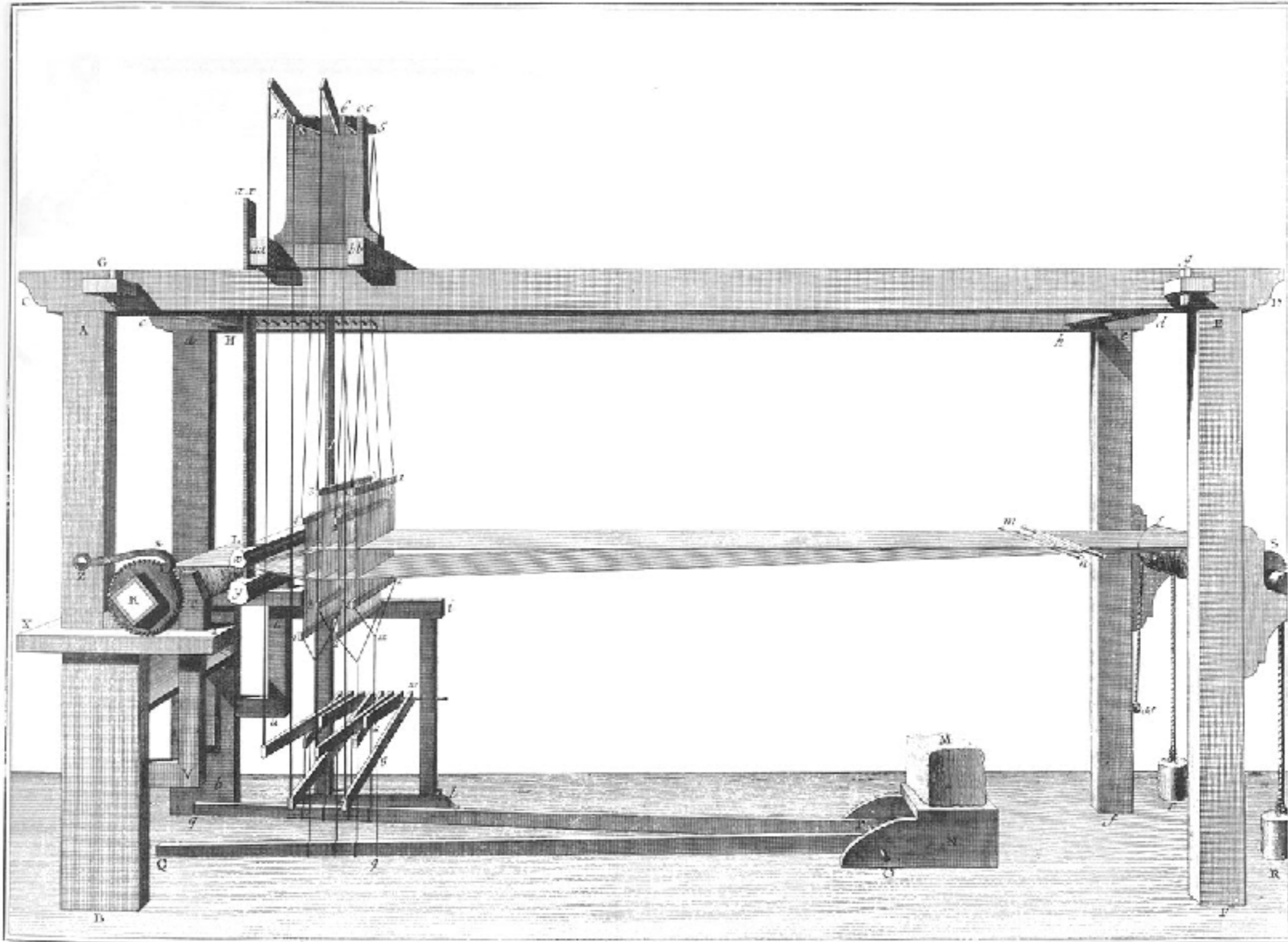

Plancher del.

Benard fecit.

*Soierie, Vue Perspective du métier pour fabriquer les Étoffes unies. Comme Taffetas, Satin et Serge, la chaîne ouverte au premier coup du Taffetas.* HH

“Soierie, ...”

The Encyclopedia of Diderot & d'Alembert 1763  
(University of Michigan)

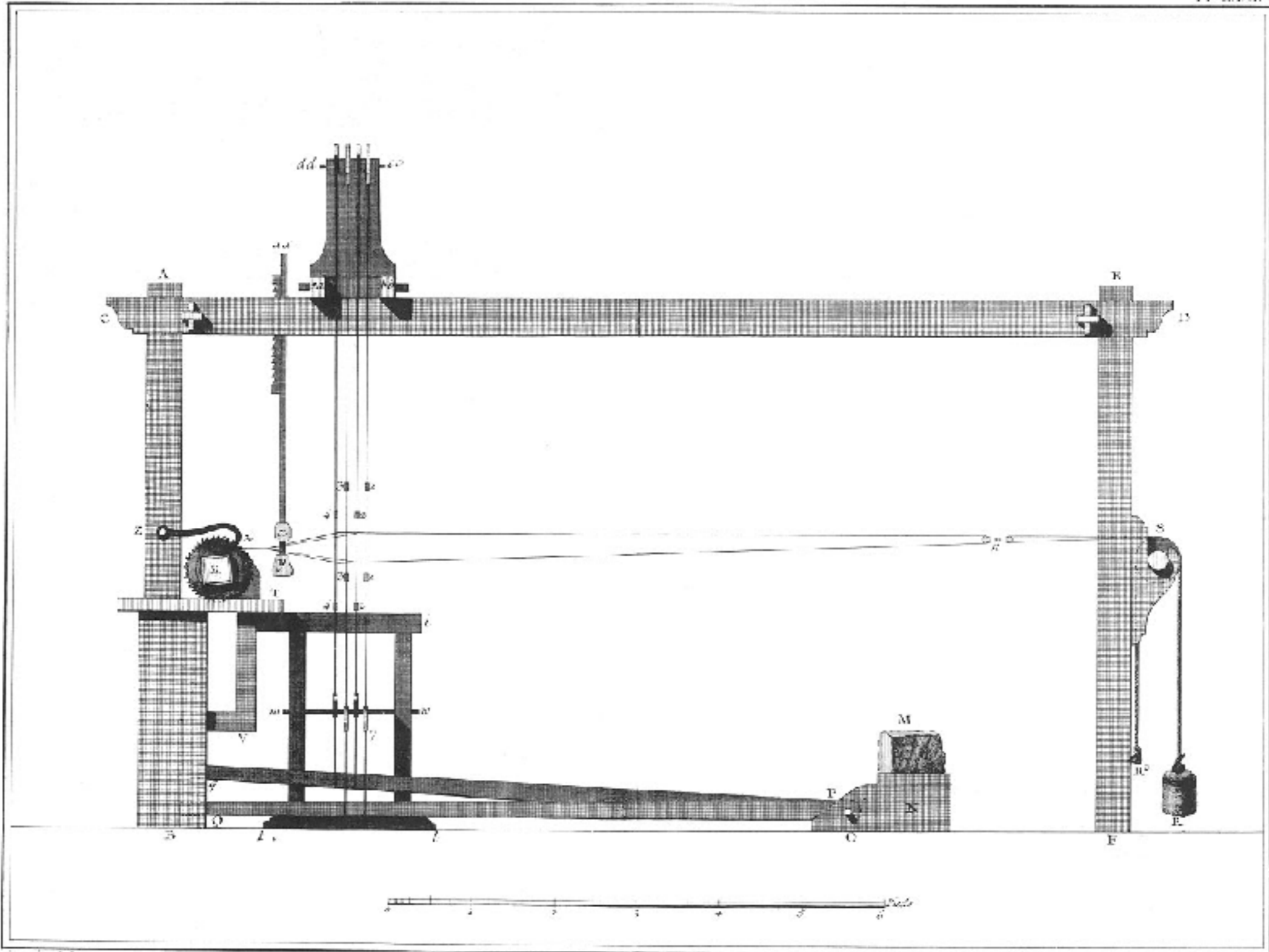

Benard Peul.

Benard Peul.

*Soierie, Elevation Géométrale de la partie Lateralle du Mélier pour fabriquer les Basses unies comme Tuffetas, Satin et Serge* II

“Soierie, ...”

The Encyclopedia of Diderot & d'Alembert 1763  
(University of Michigan)

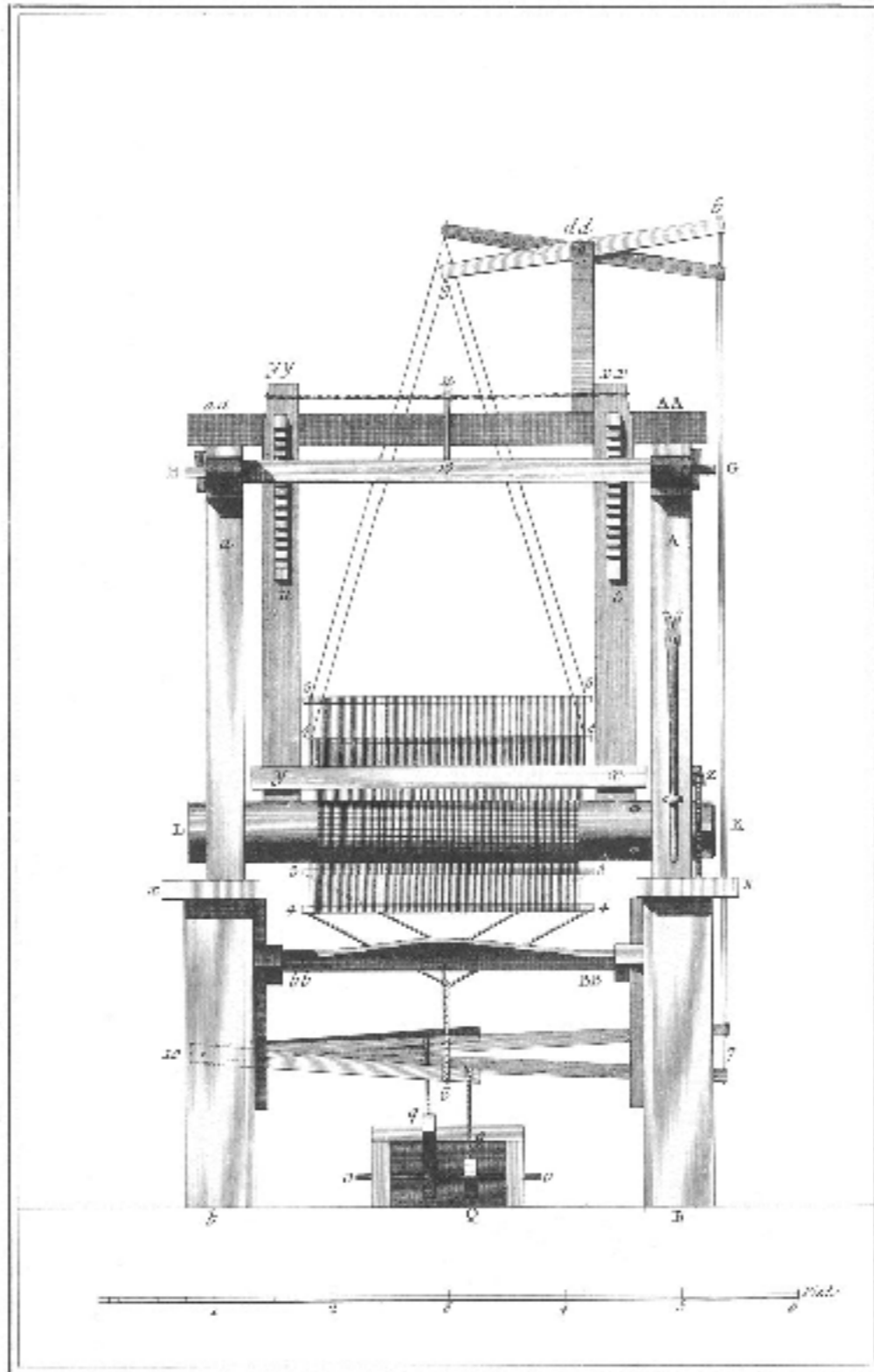

*Soierie, Élévation Géométrale de la partie antérieure  
du métier pour fabriquer les étoffes unies, comme Taffetas, satin, et Serge.* KK

“Soierie, ...”

The Encyclopedia of Diderot & d'Alembert 1763  
(University of Michigan)

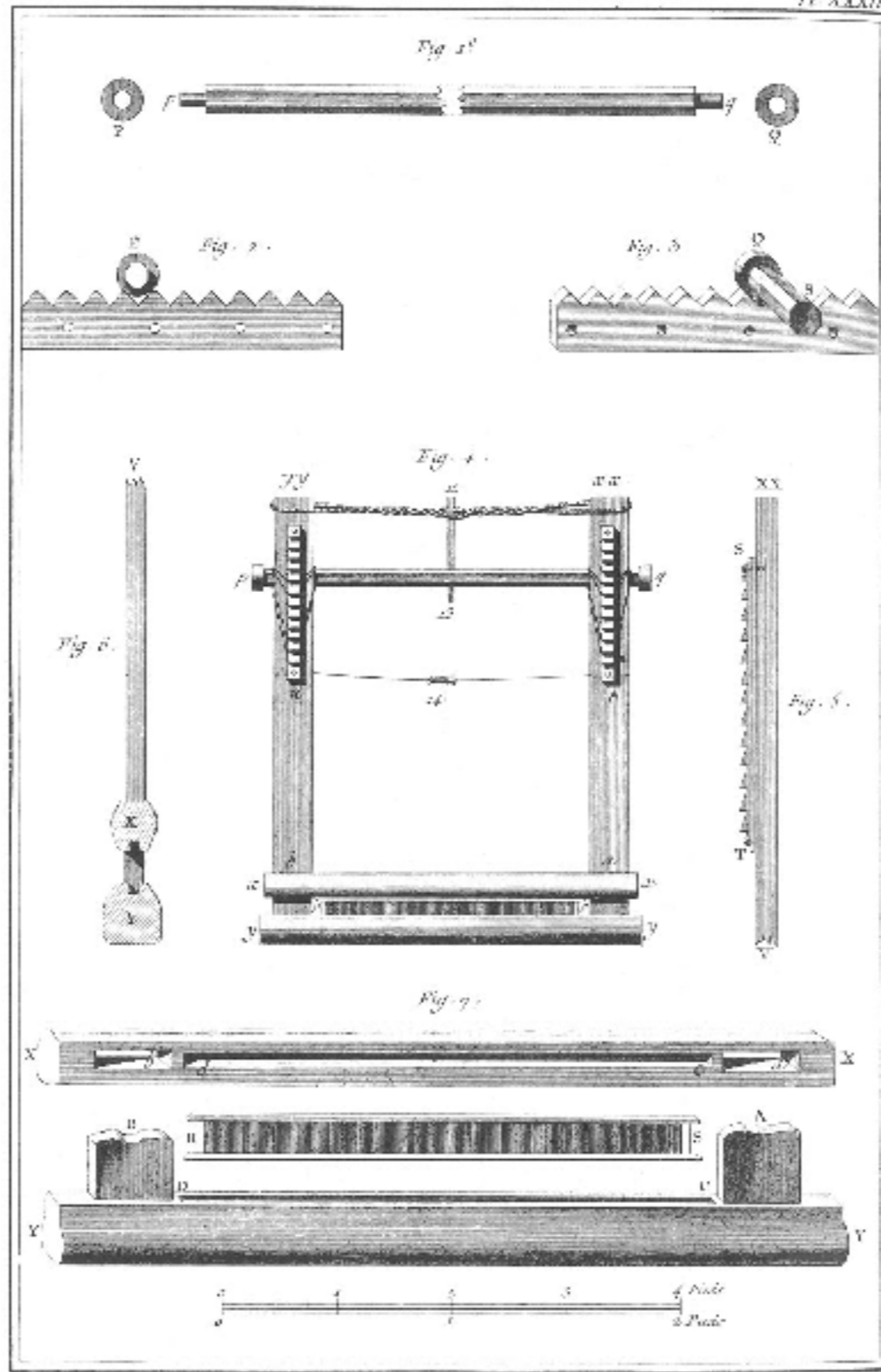

Benard 206

Benard 206

*Soierie, Développement du Basot du Mâtier pour fabriquer les Filles.* I.L.

“Soierie, ...”

The Encyclopedia of Diderot & d'Alembert 1763  
(University of Michigan)

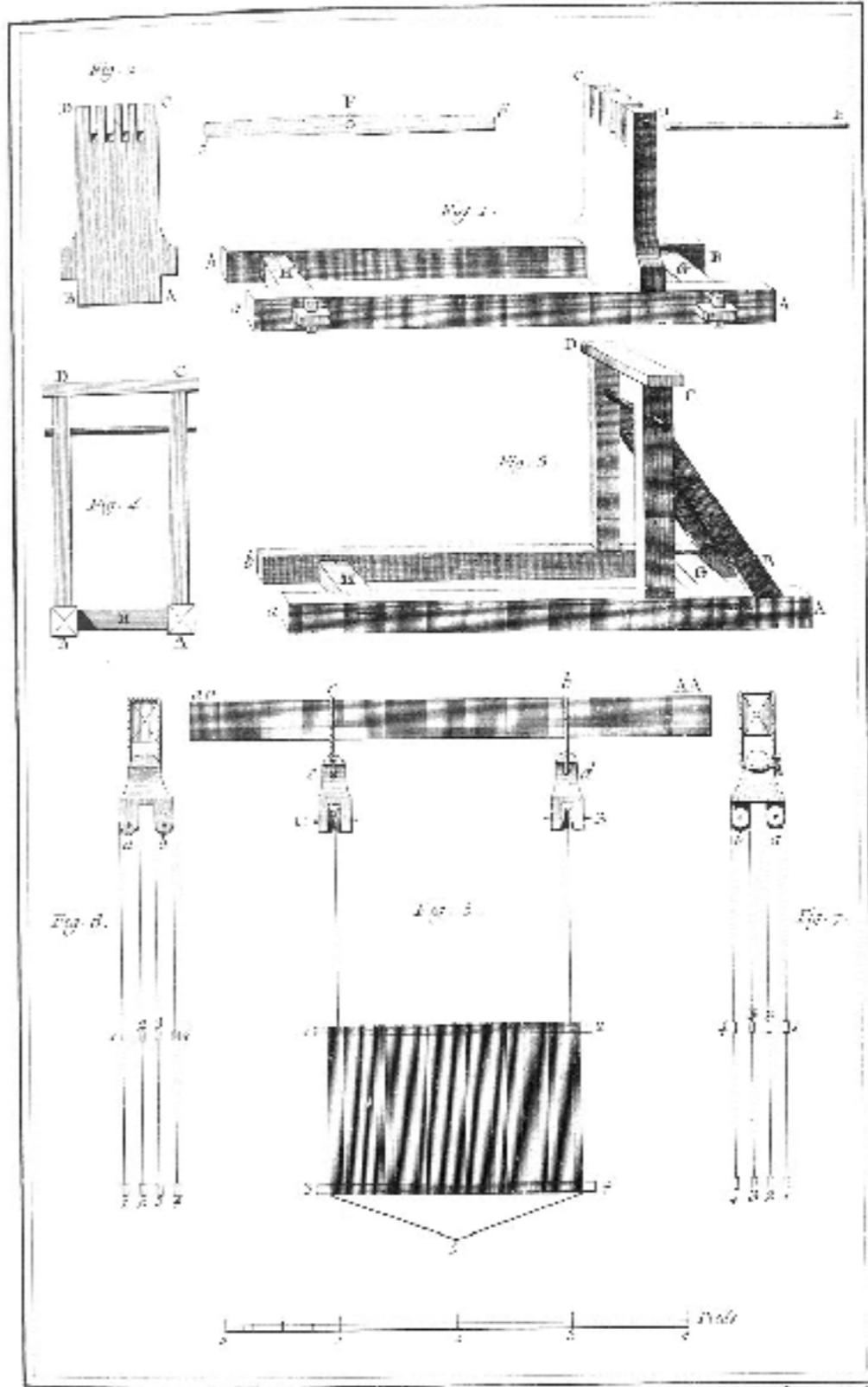

Soierie, Développement de la Cuculle et du Porte-Licse.

M31

“Soierie, ...”

The Encyclopedia of Diderot & d'Alembert 1763  
(University of Michigan)

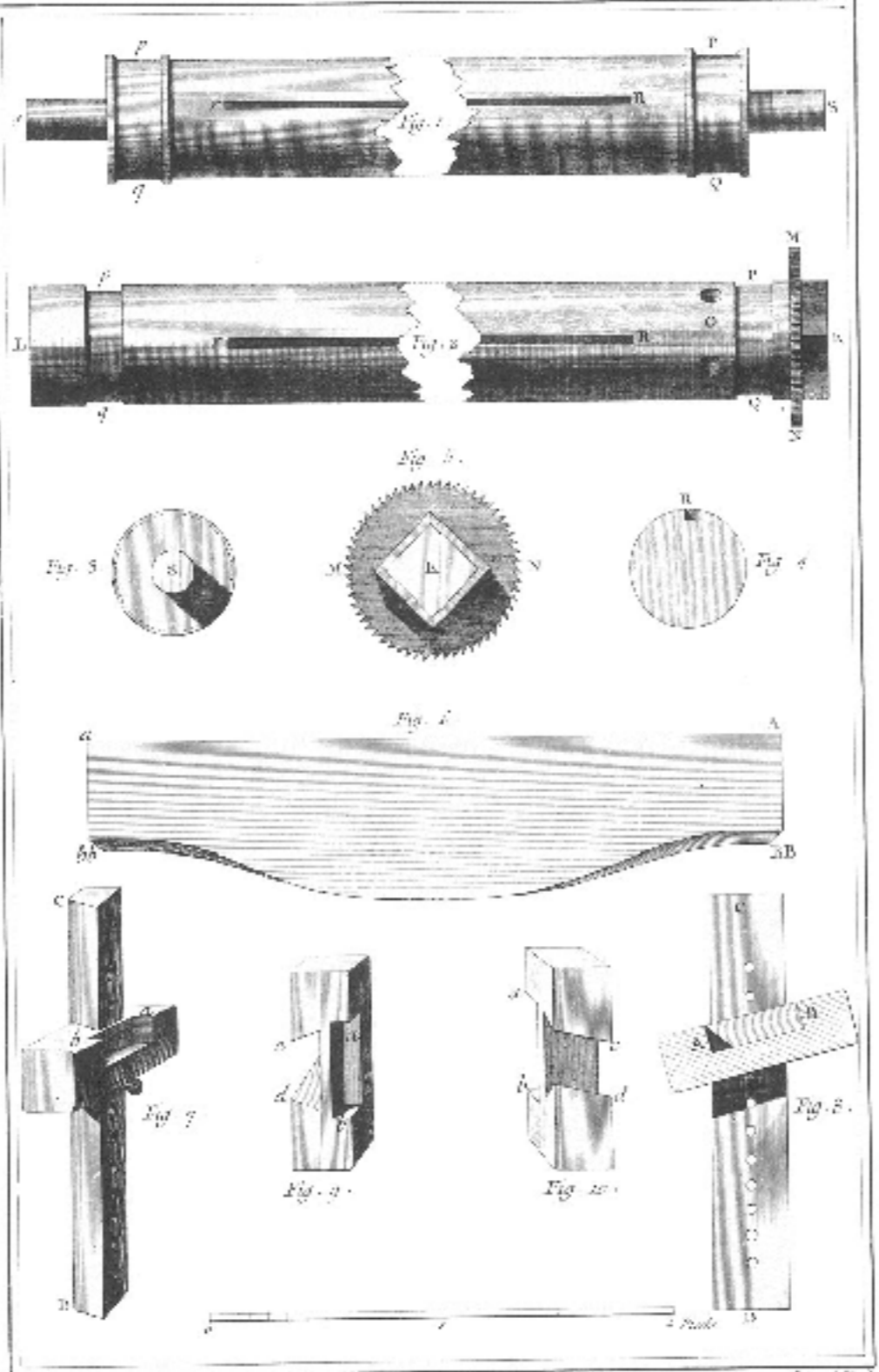

*Soierie, développement des Envelopes du métal pour fabriquer les Etoffes, et Construction du tronc de l'Ourier.*

“Soierie, ...”

The Encyclopedia of Diderot & d'Alembert 1763  
(University of Michigan)

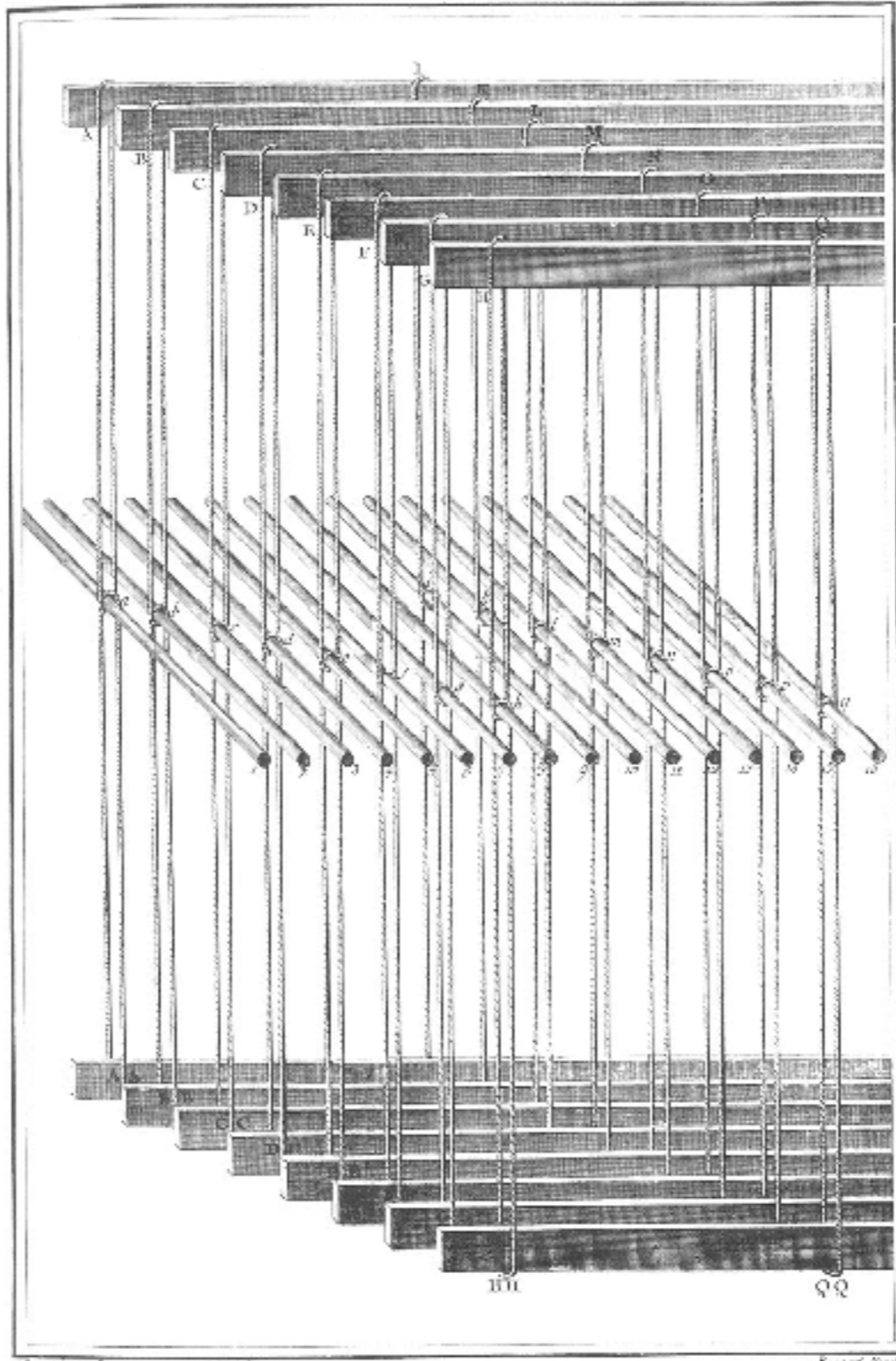

*Encour. 2d.*

*Repart. 2d.*

*SOIERIE, Remettage ou Passage des Fils de la Chaîne dans les Taffets.*

“Soierie, ...”

The Encyclopedia of Diderot & d'Alembert 1763  
(University of Michigan)

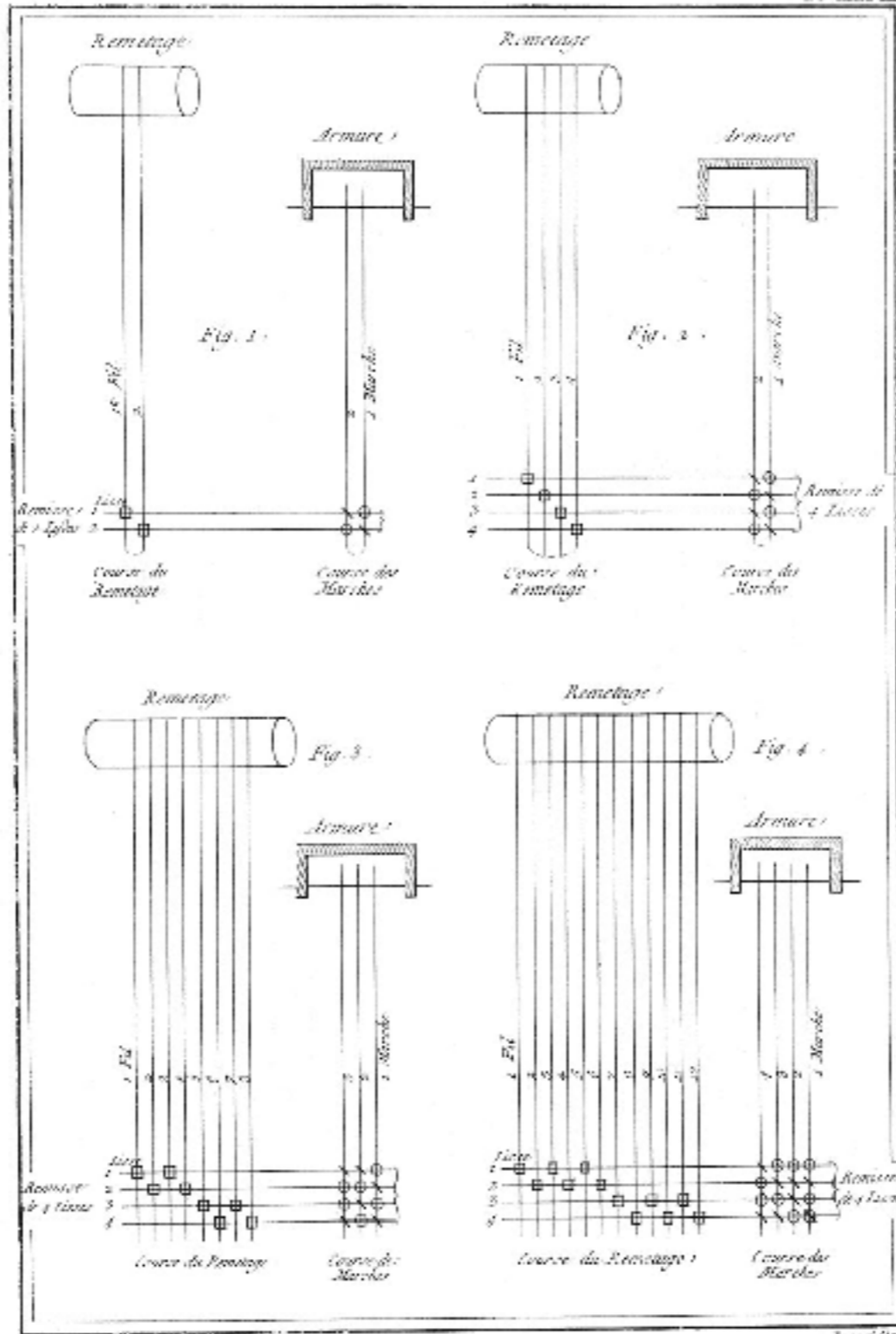

Soierie, Armures du Taffetas à 2 Lisses ou Armures, autre Armure générale pour toutes sortes de Taffetas et Gros de Tours: Armure de l'Ettoffe nommée Vrai de Poille, et Armure pour la Siamoise.

“Soierie, ...”

The Encyclopedia of Diderot & d'Alembert 1763  
(University of Michigan)

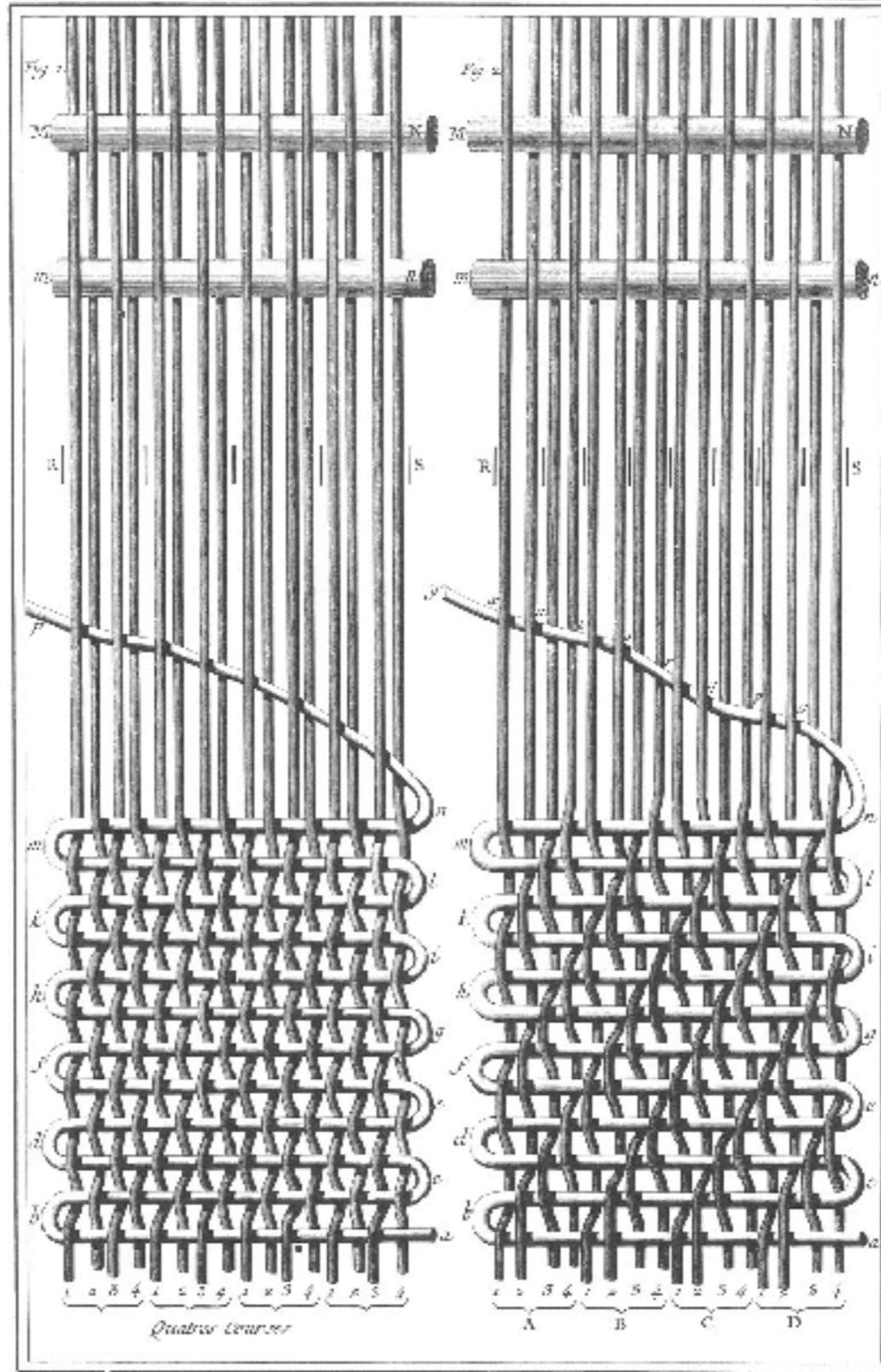

Soierie, Ruffes en Plain, le Taffetas et le Ras de St. Sire.

Q Q

“Soierie, ...”

The Encyclopedia of Diderot & d'Alembert 1763  
(University of Michigan)

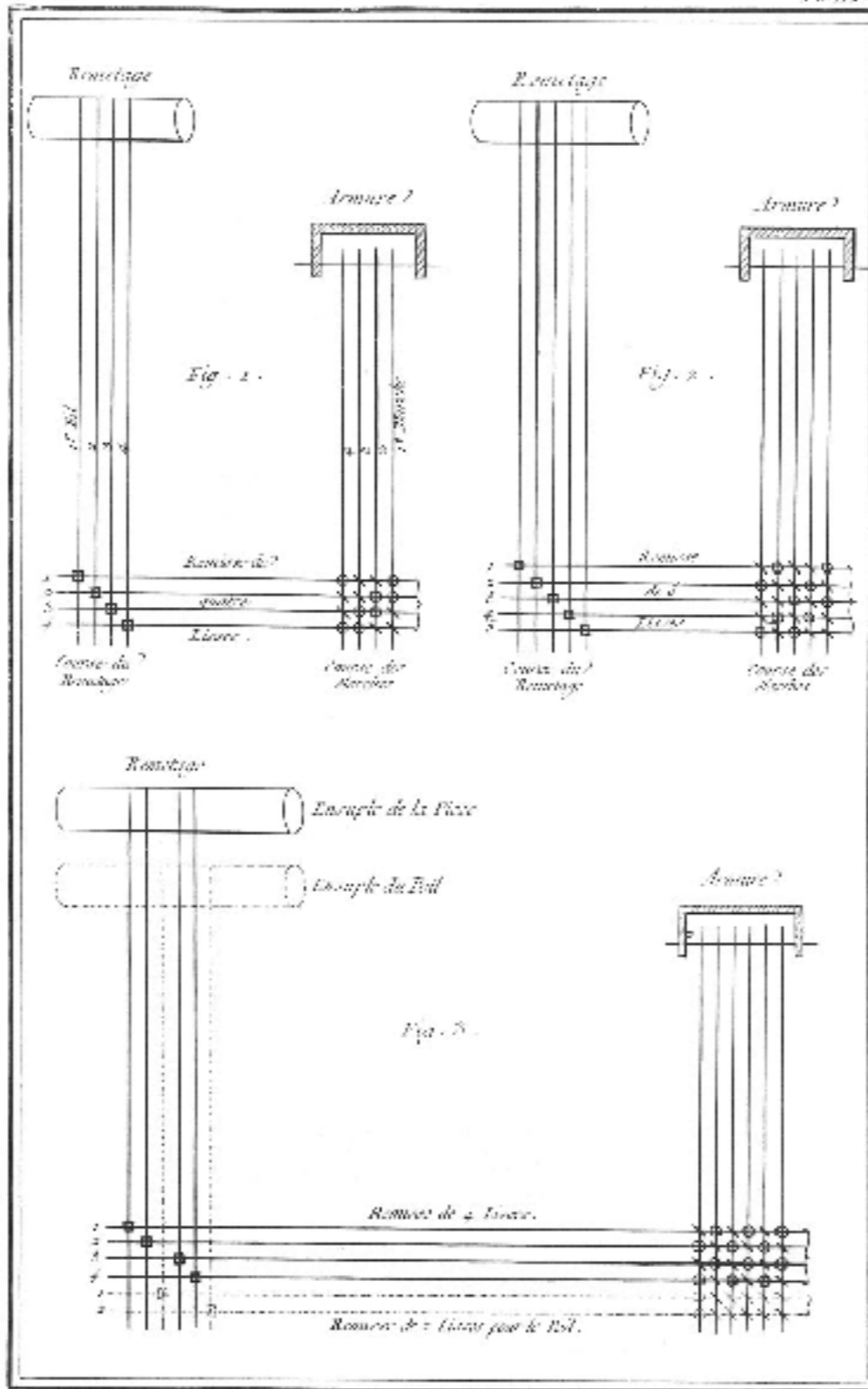

*Soierie*. RR  
 1. Raz de St. Maur, 2. Stoffe qui est Gros de Naples d'un côté et Raz de St. Maur de l'autre, 3. Canelé à Poil.

“Soierie, ...”

The Encyclopedia of Diderot & d'Alembert 1763  
 (University of Michigan)

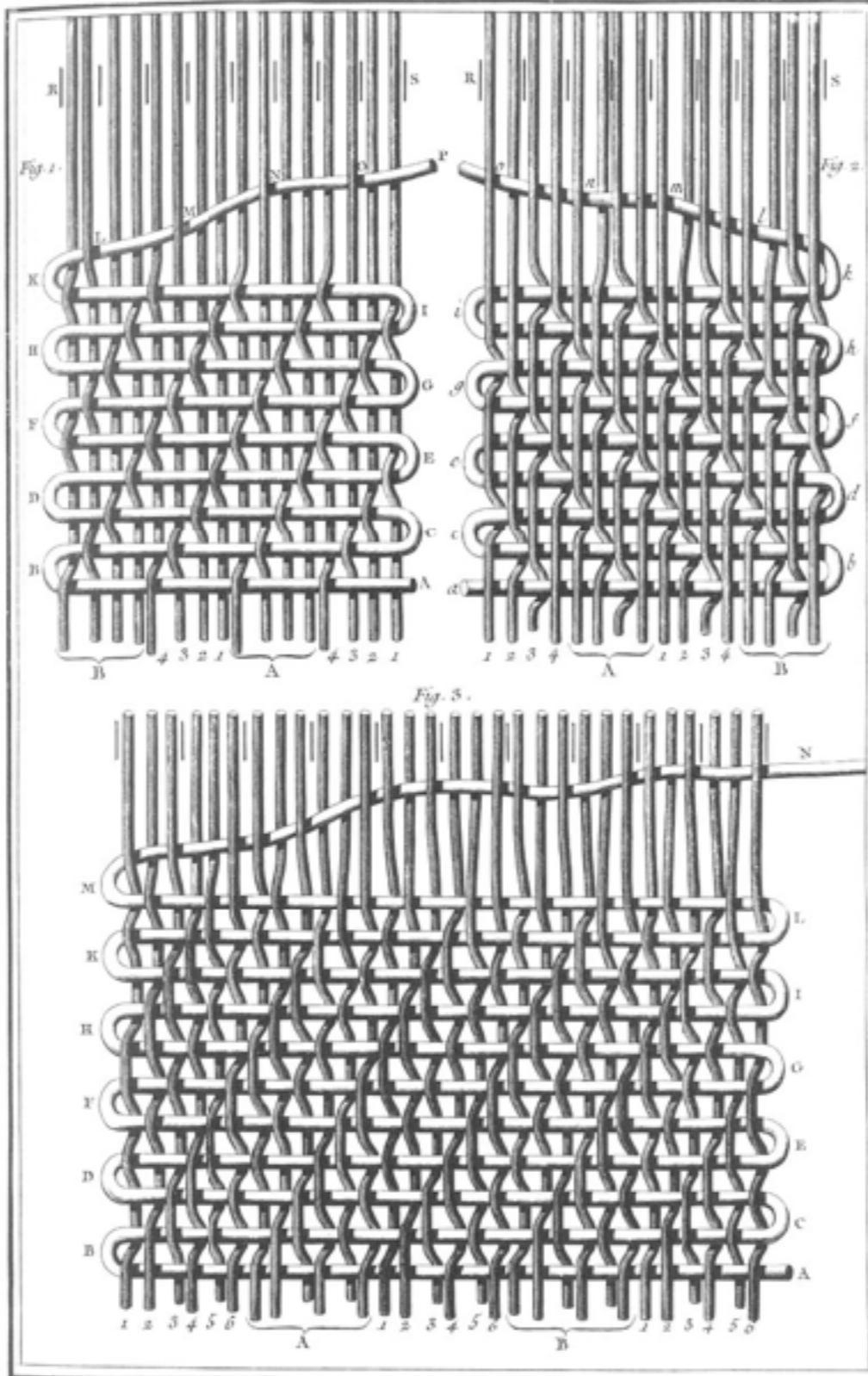

Chausser Bel.

Amant Fecit.

*Soierie,*  
*Étoffes en Plein, la Serge satinée et la Serge à 6 Lisses.*

VV

“Soierie, ...”

The Encyclopedia of Diderot & d'Alembert 1763  
 (University of Michigan)

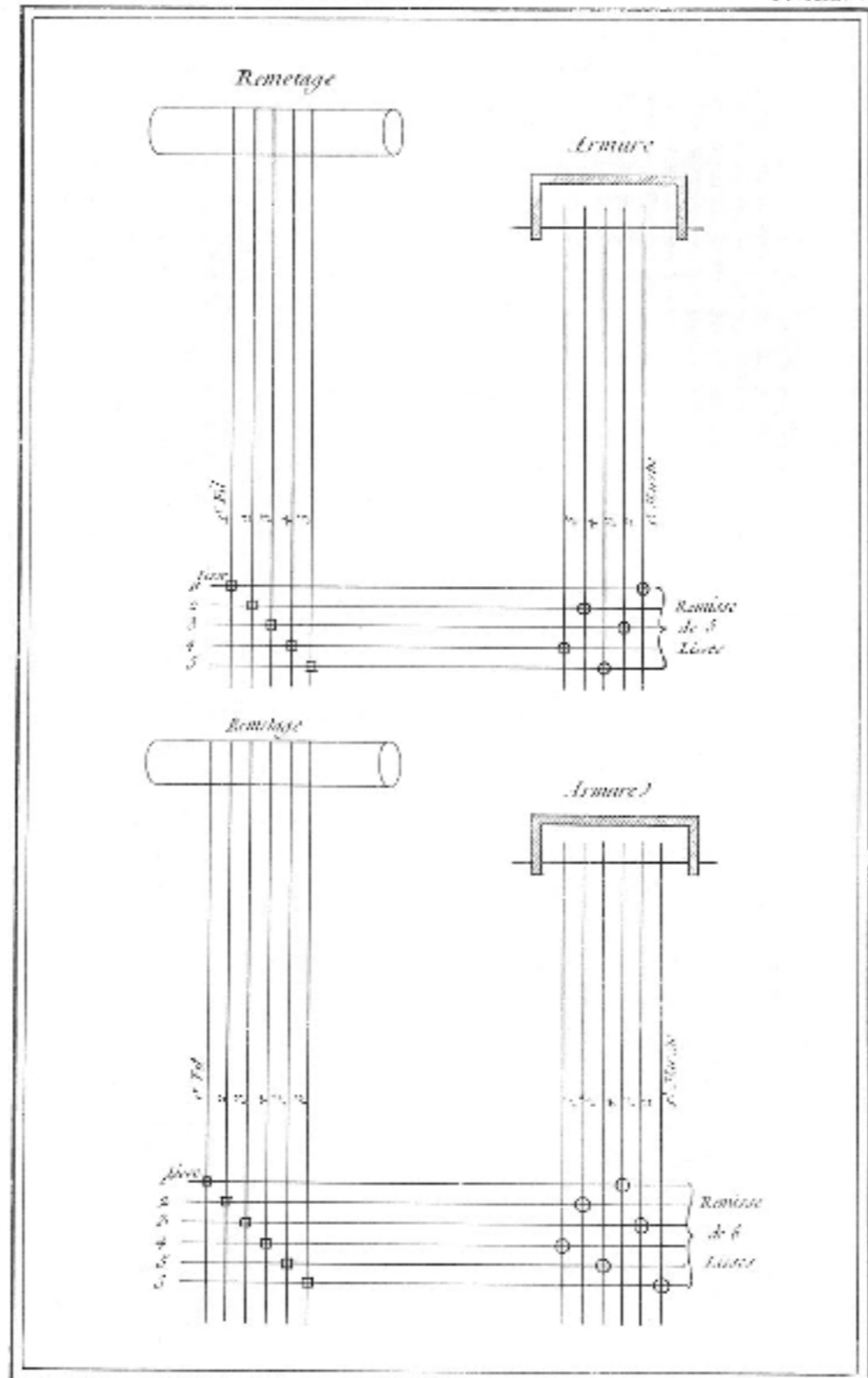

Remetage Armure 2

Soierie 2

Satin à 5 Lisses et Satin à 6 Lisses.

“Soierie, ...”

The Encyclopedia of Diderot & d'Alembert 1763  
(University of Michigan)

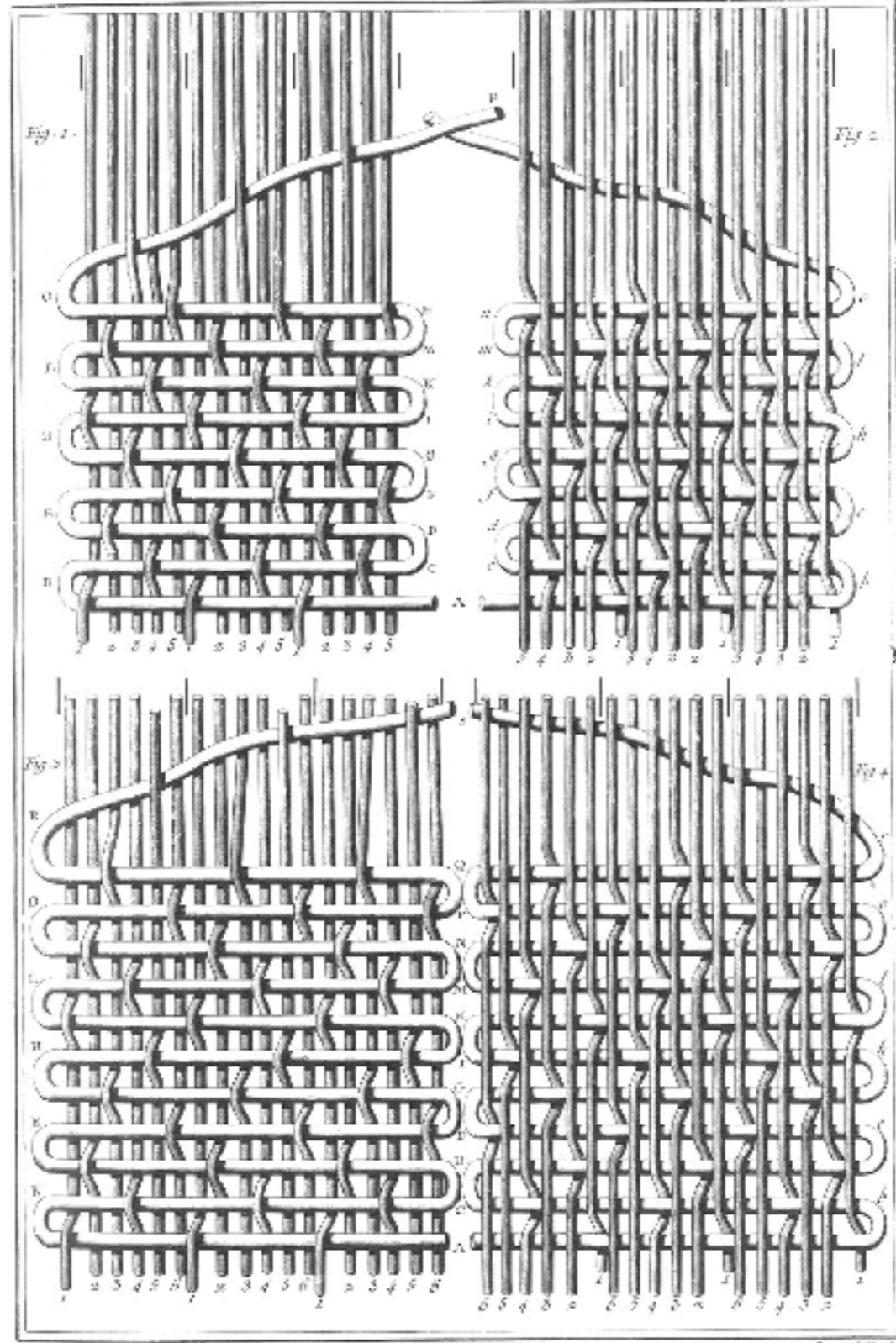

*Soierie, Étoffes en Plein, satin à 6, à 6 Lisses vue du côté de l'envers et du côté de l'endroit.*

“Soierie, ...”

The Encyclopedia of Diderot & d'Alembert 1763  
(University of Michigan)

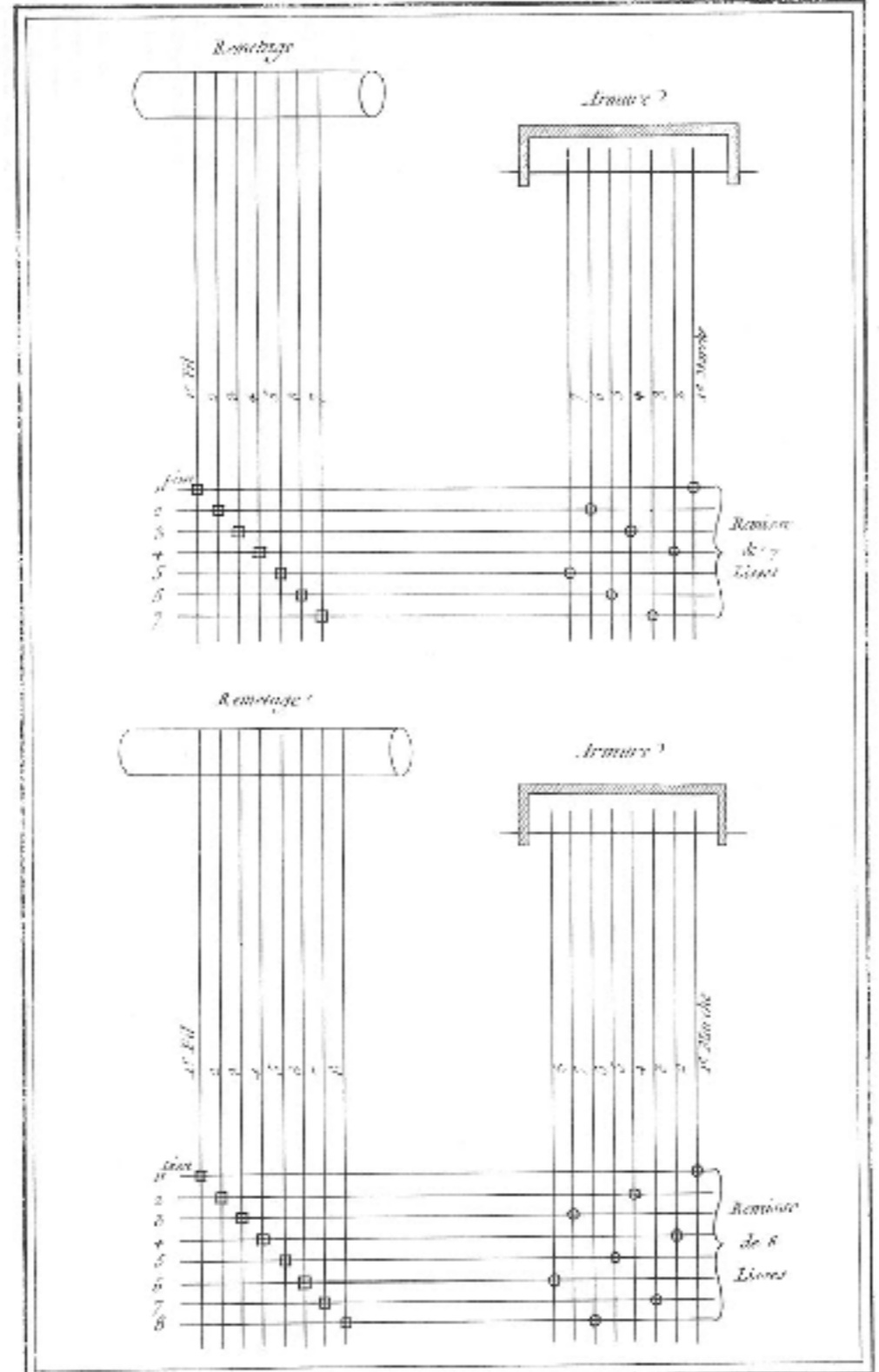

Source: 101

Source: 101

*Soierie*

*Satin à 7 lisses et Satin à 8 Lisses.*

T. 1.

“Soierie, ...”

The Encyclopedia of Diderot & d'Alembert 1763  
(University of Michigan)

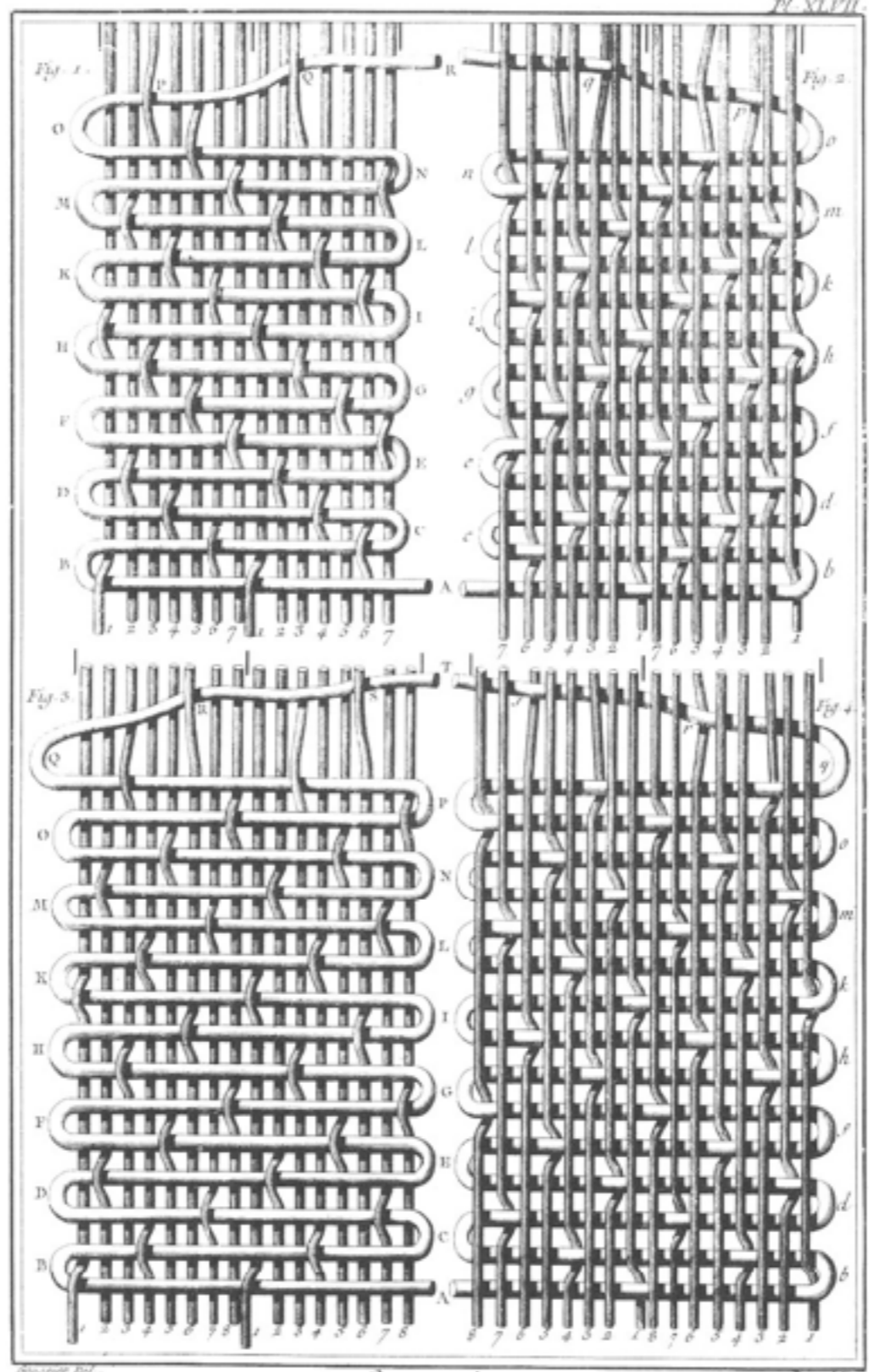

*Soierie,*  
*Étoffes en Plein, Satin à 7 Torsas et Satin à 8. Vus par l'Envers et l'Endroit.*

“Soierie, ...”

The Encyclopedia of Diderot & d'Alembert 1763  
 (University of Michigan)

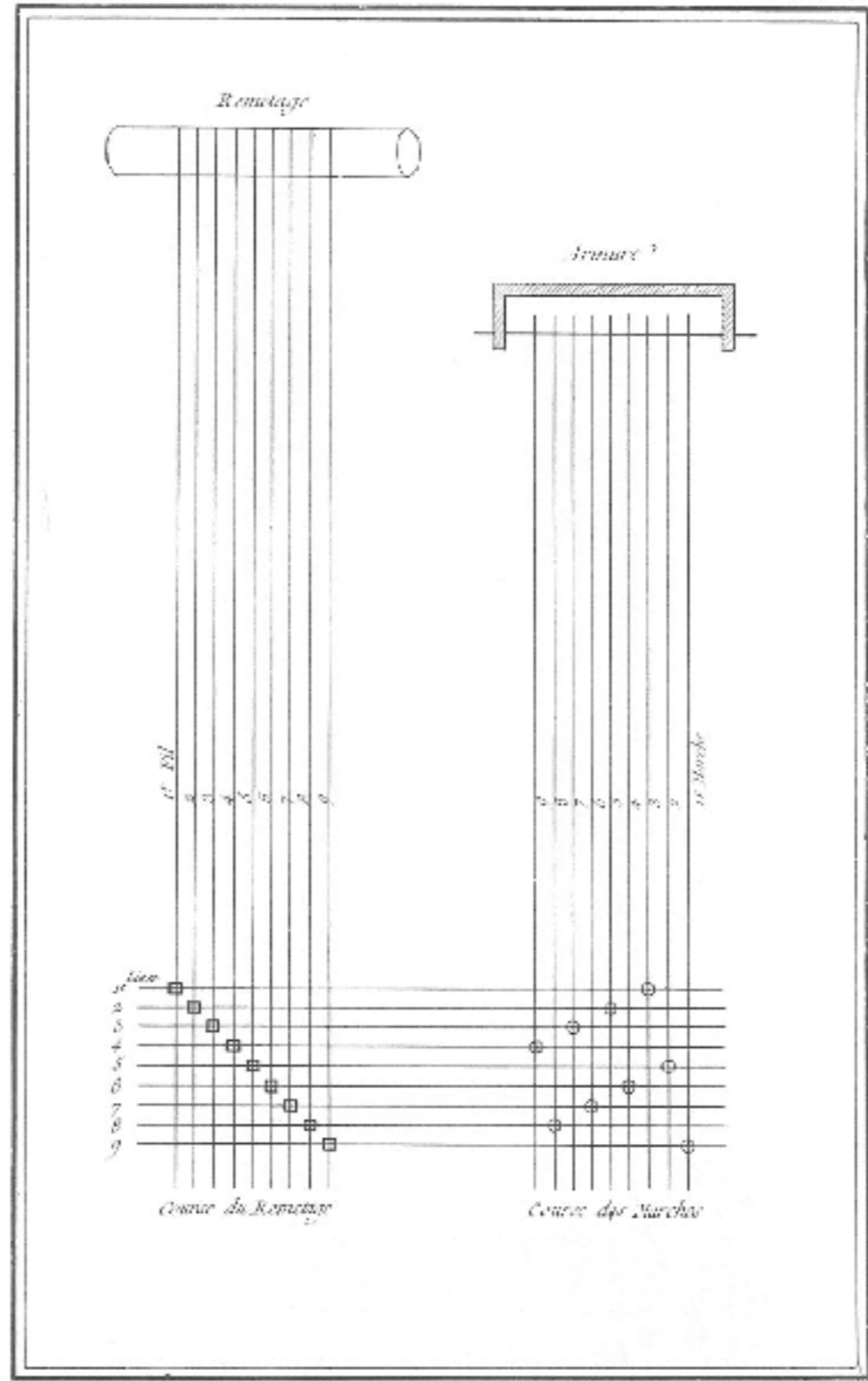

Gravé par Del.

Benard Del.

*Soierie, satin à 9 Lisses.* b

“Soierie, ...”

The Encyclopedia of Diderot & d'Alembert 1763  
(University of Michigan)

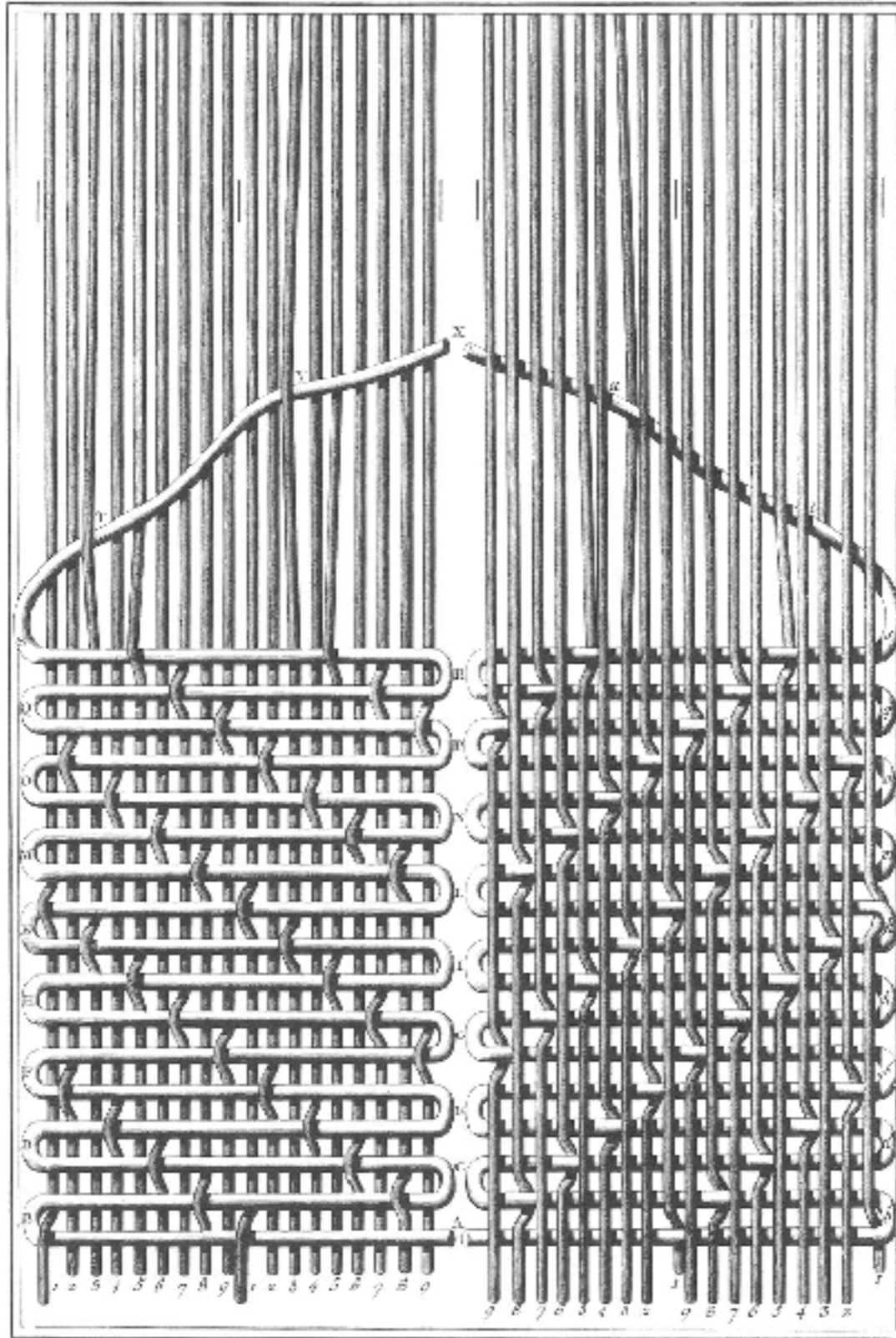

Benard Esc.

Benard Esc.

*Soierie, satin à 9 lisses vu du côté de l'envers et du côté de l'endroit.*

“Soierie, ...”

The Encyclopedia of Diderot & d'Alembert 1763  
(University of Michigan)

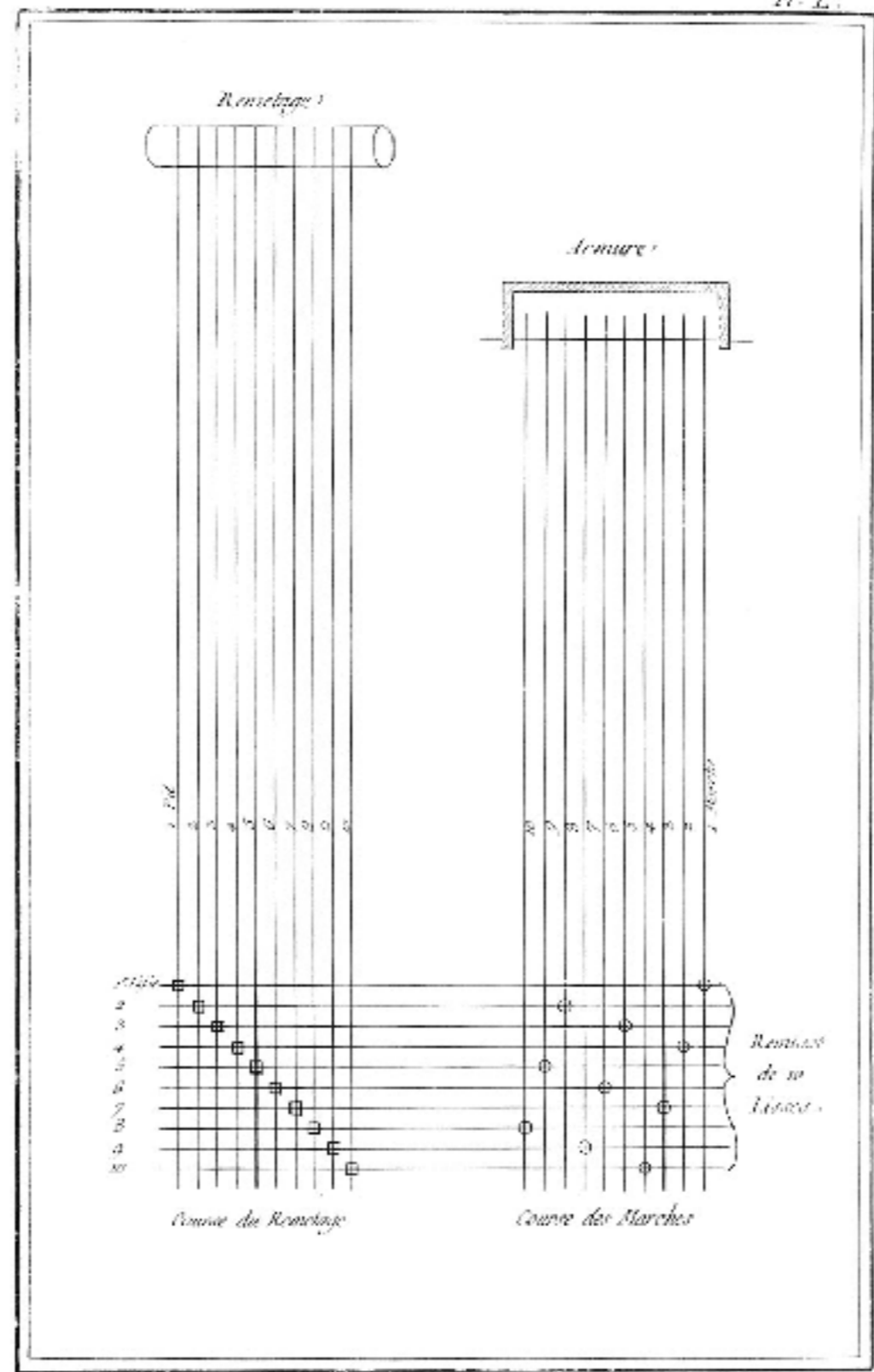

*Soierie,  
Satin à Dix Lisses.*

"Soierie, ..."

The Encyclopedia of Diderot & d'Alembert 1763  
(University of Michigan)

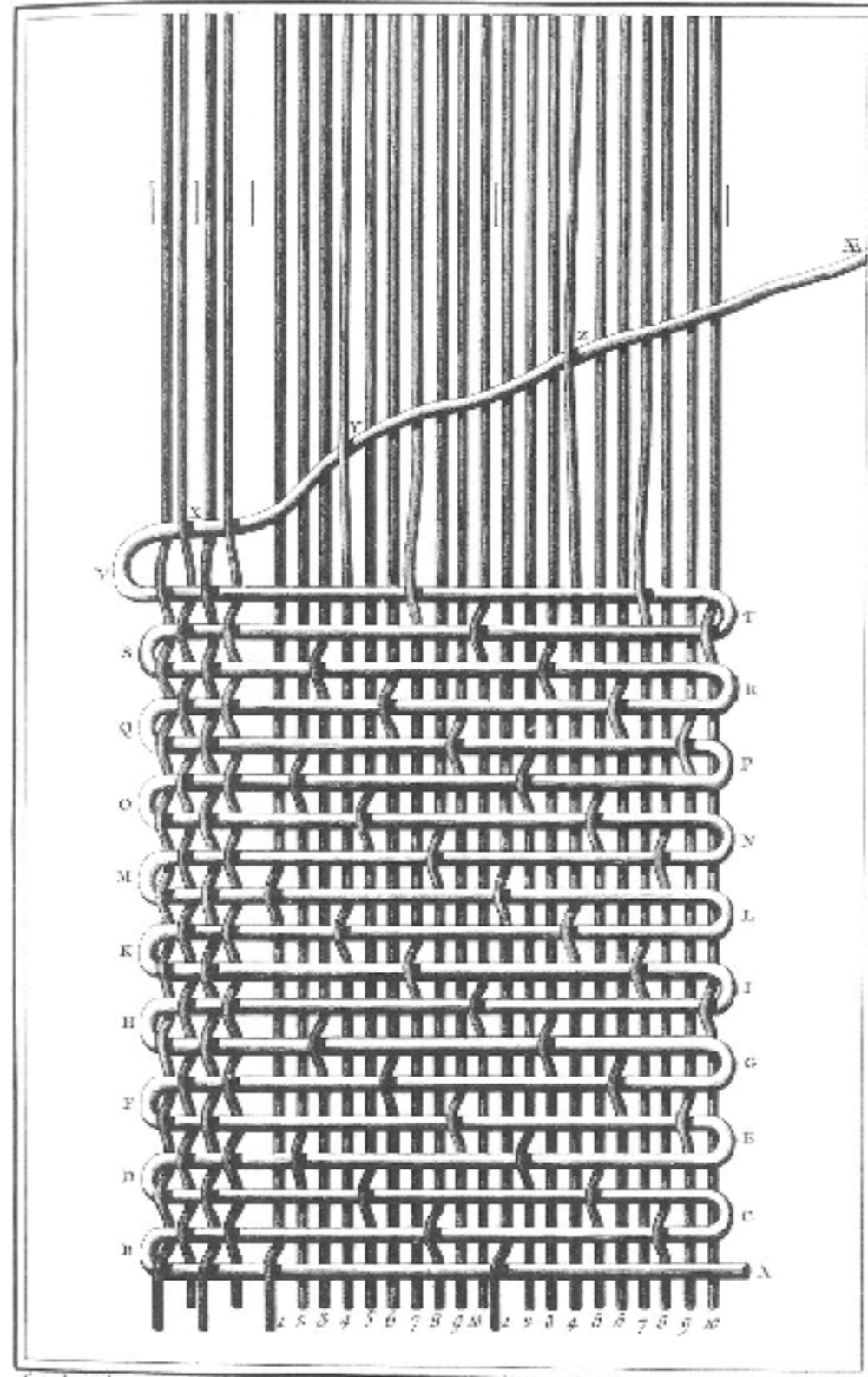

Gravé par Del.

Essai de l'art.

*Soierie, Etoffe en Plein, Satin à dix Lisses Vu du côté de l'envers.*

“Soierie, ...”

The Encyclopedia of Diderot & d'Alembert 1763  
(University of Michigan)

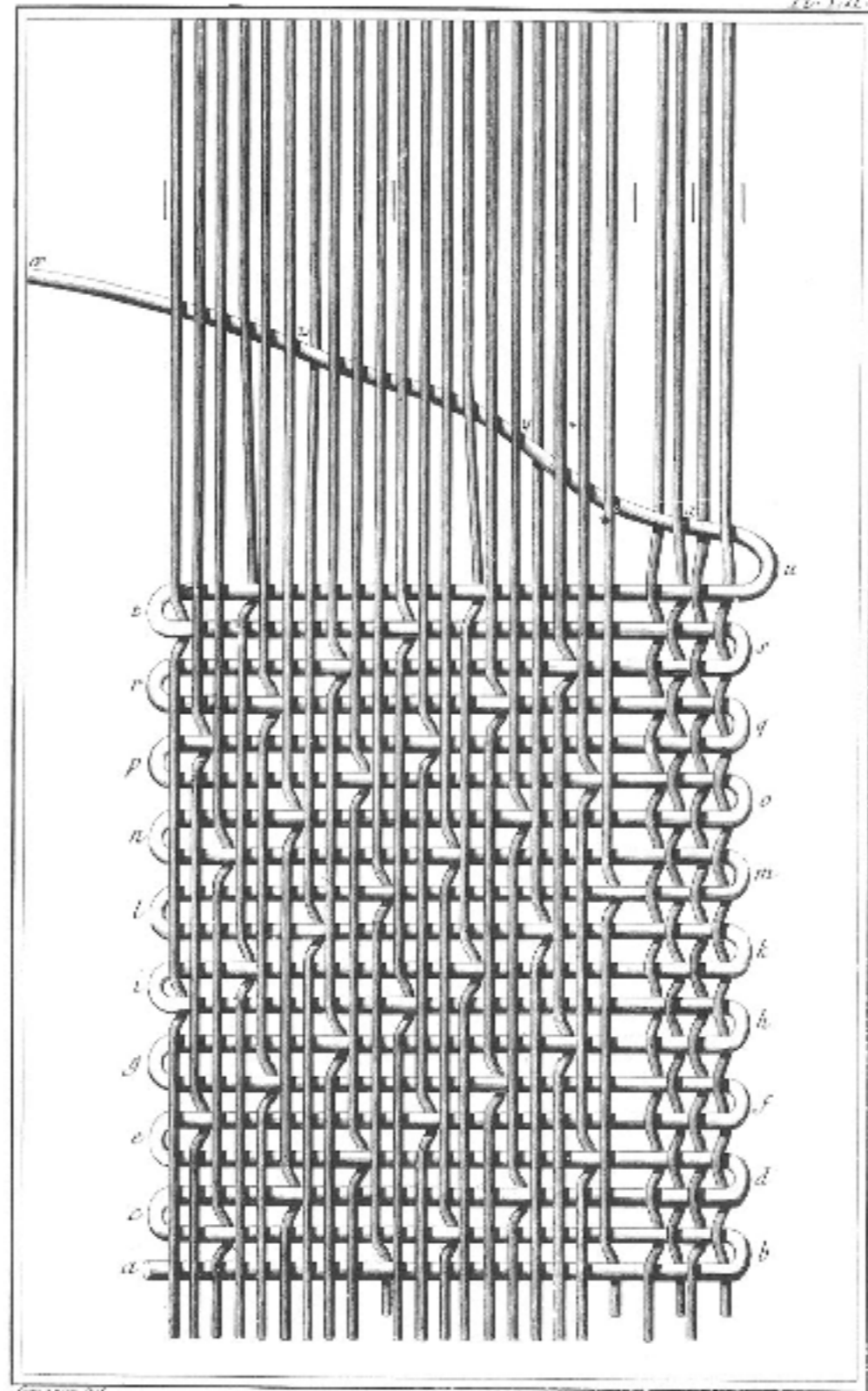

Benard del.

Benard fecit.

*Soierie, Etoffes en Plein, Satin à dix Lignes Vu du côté de l'endroit.*

“Soierie, ...”

The Encyclopedia of Diderot & d'Alembert 1763  
(University of Michigan)

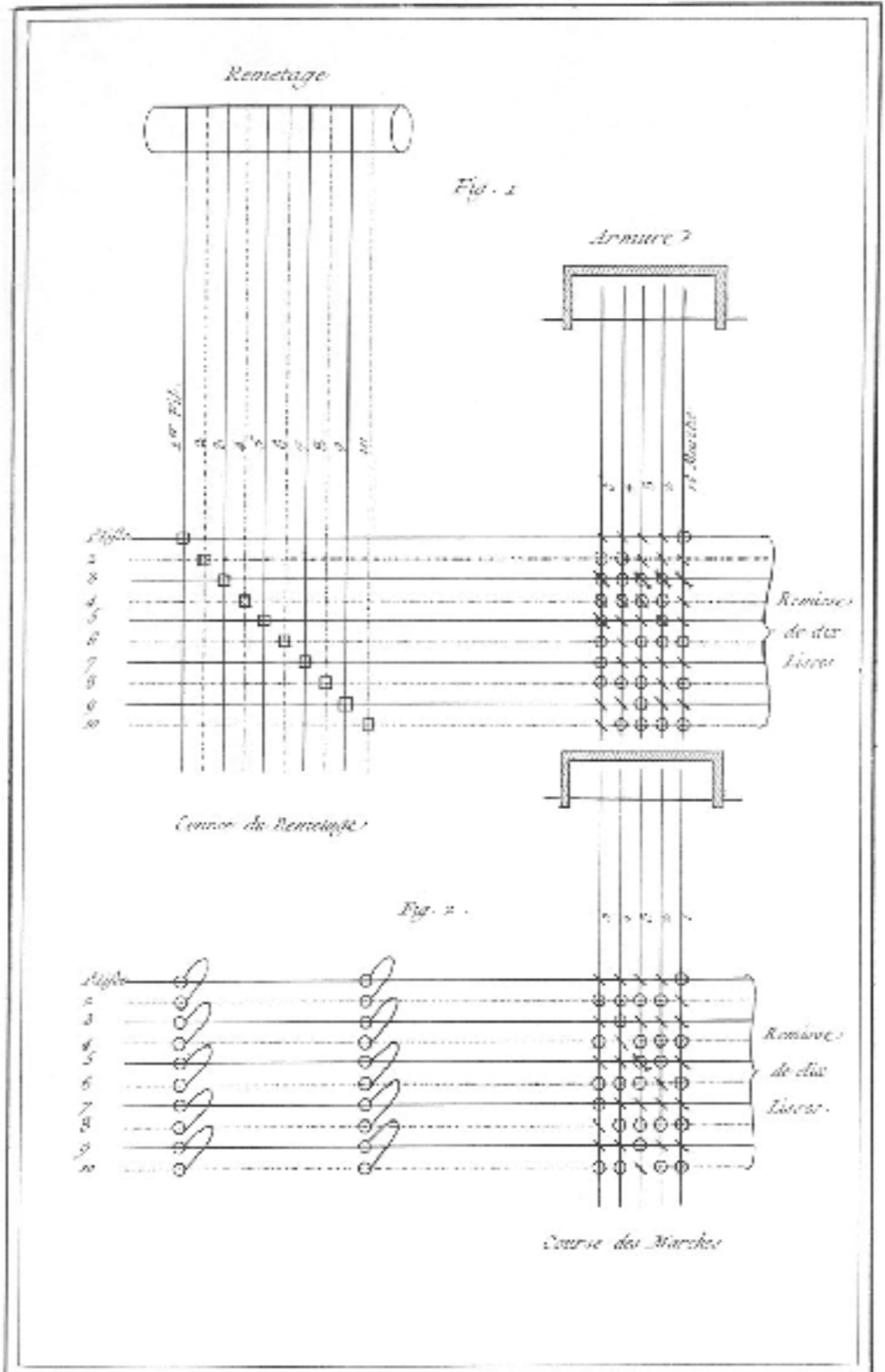

Gravé par Del.

Benard fecit.

Soierie,  
Satin à deux faces Blanc d'un côté et Noir de l'autre.

9

“Soierie, ...”

The Encyclopedia of Diderot & d'Alembert 1763  
(University of Michigan)

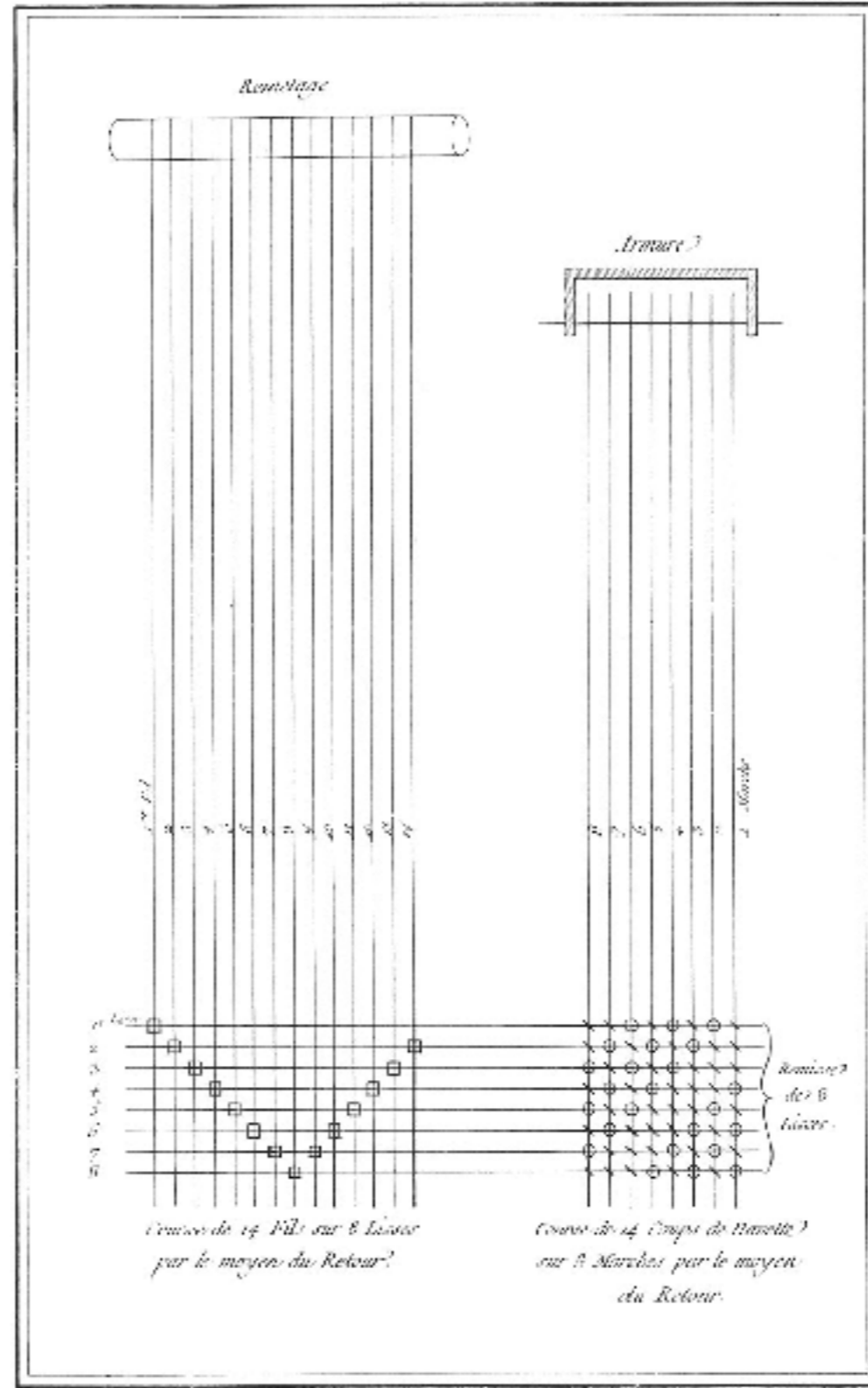

### Soierie.

*Chenette sans Peil, qui conduit à plusieurs petites soies dans le fond des Fustes.*

“Soierie, ...”

The Encyclopedia of Diderot & d'Alembert 1763  
(University of Michigan)

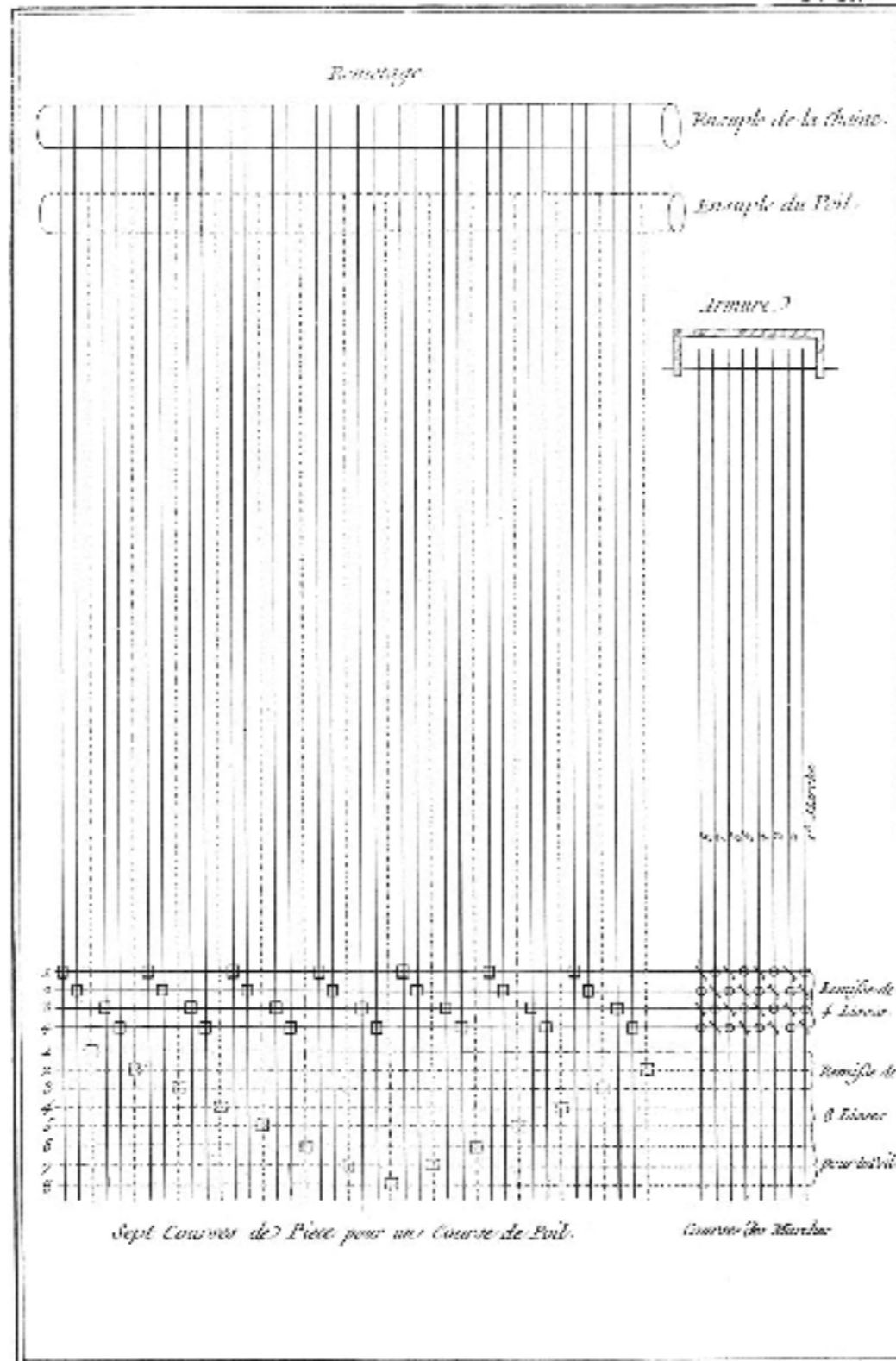

*Soierie*

*Travail à petite Chaine dans laquelle on peut faire plusieurs petites façons de la grosseur d'un Poul.*

“Soierie, ...”

The Encyclopedia of Diderot & d'Alembert 1763  
(University of Michigan)

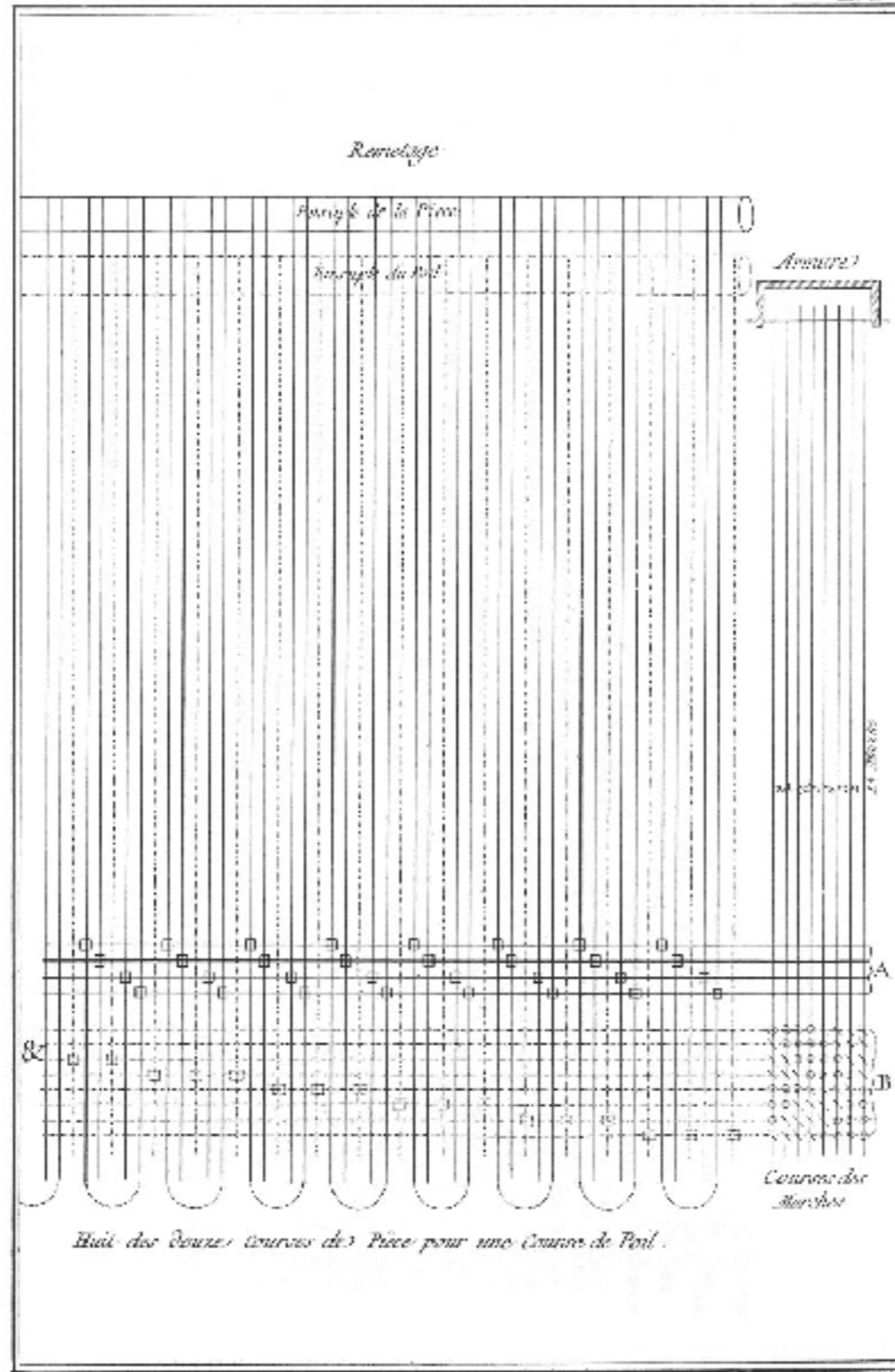

Benard del.

Benard scul.

*Soierie, Etoffe appellée Maubois.*

k

“Soierie, ...”

The Encyclopedia of Diderot & d'Alembert 1763  
(University of Michigan)

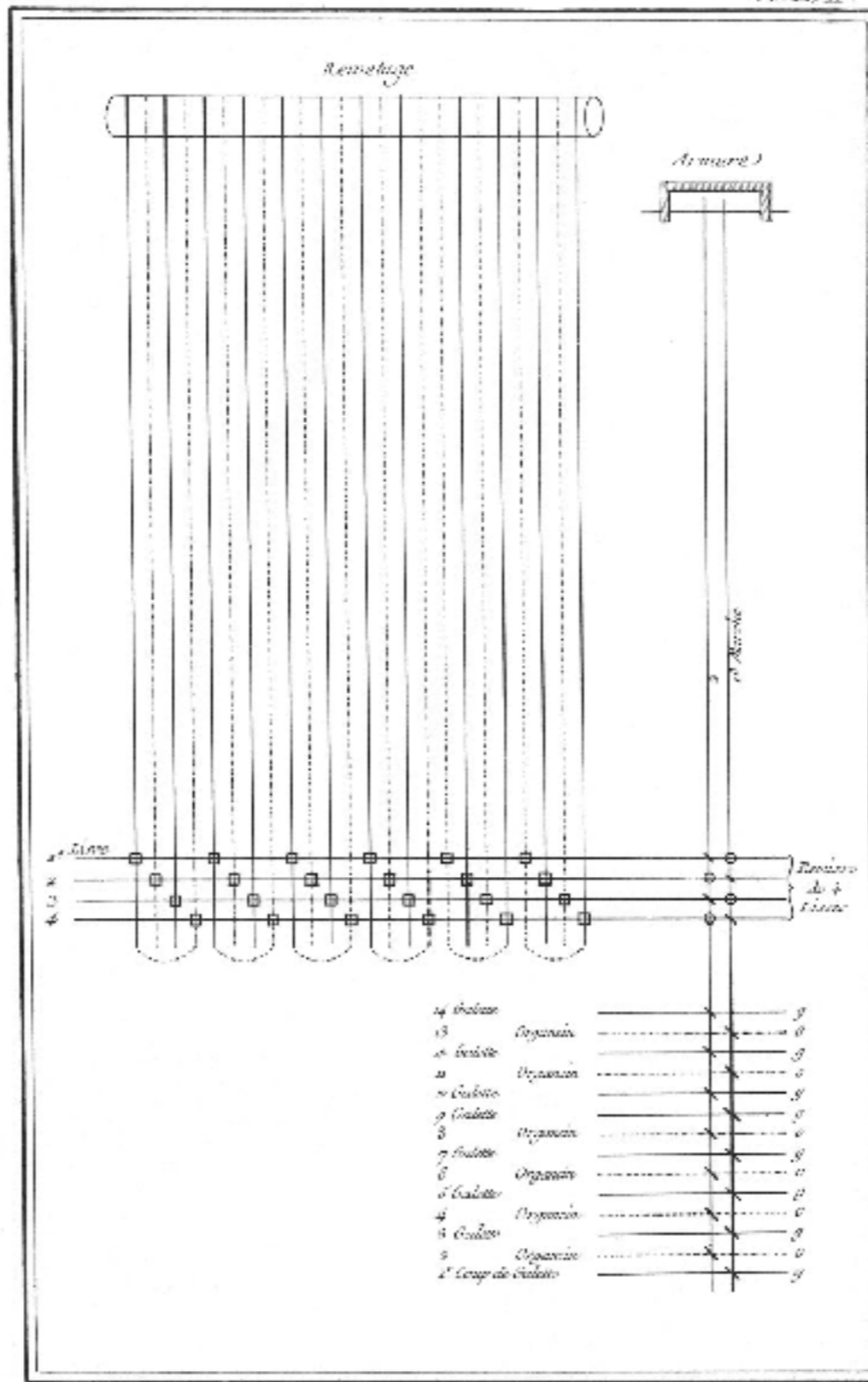

Deuxier del.

Bonard Stich.

Soierie, carele en deux couleurs

6

“Soierie, ...”

The Encyclopedia of Diderot & d'Alembert 1763  
(University of Michigan)

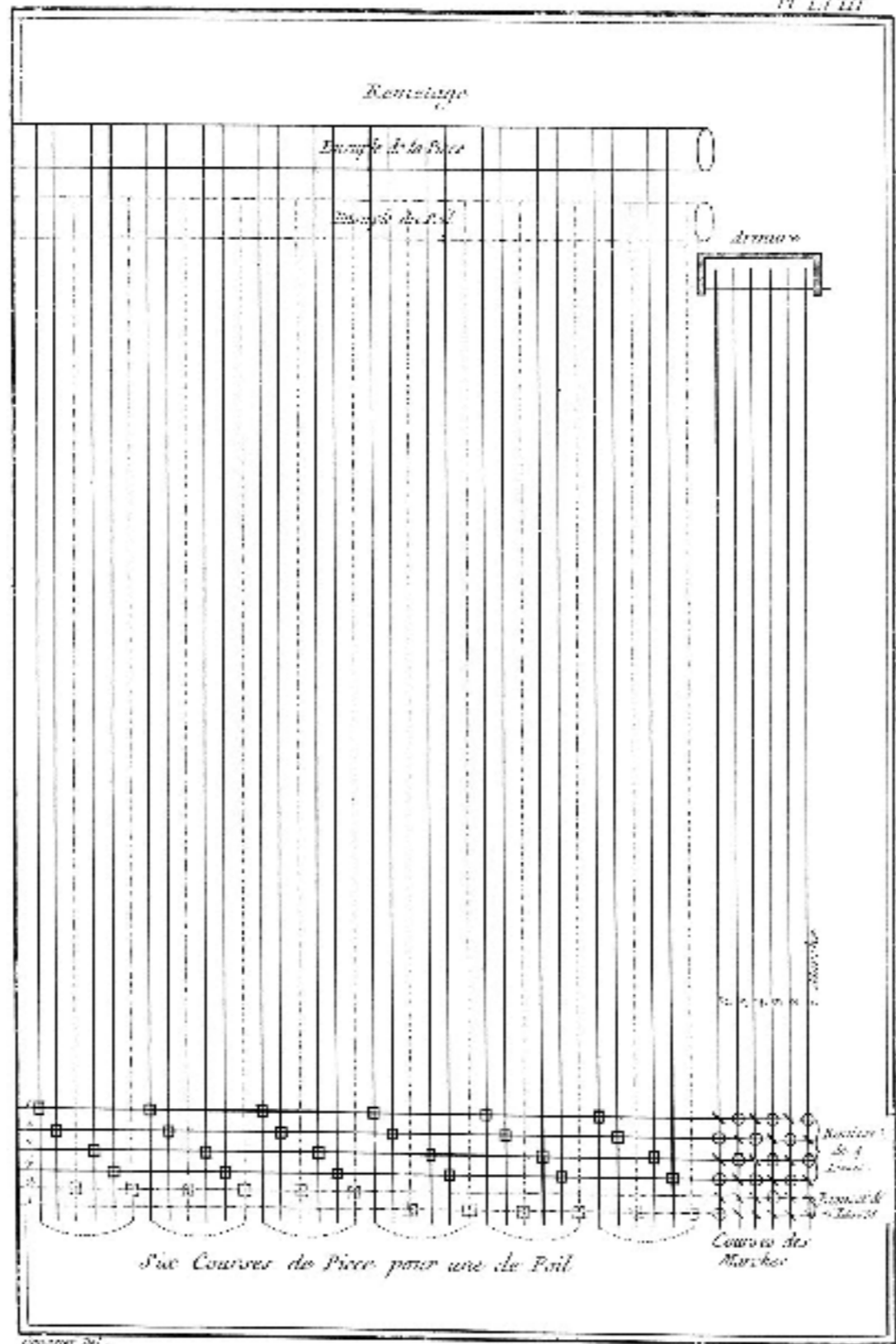

*Soierie, Carrel à Poil ou Paillettes*

“Soierie, ...”

The Encyclopedia of Diderot & d'Alembert 1763  
(University of Michigan)

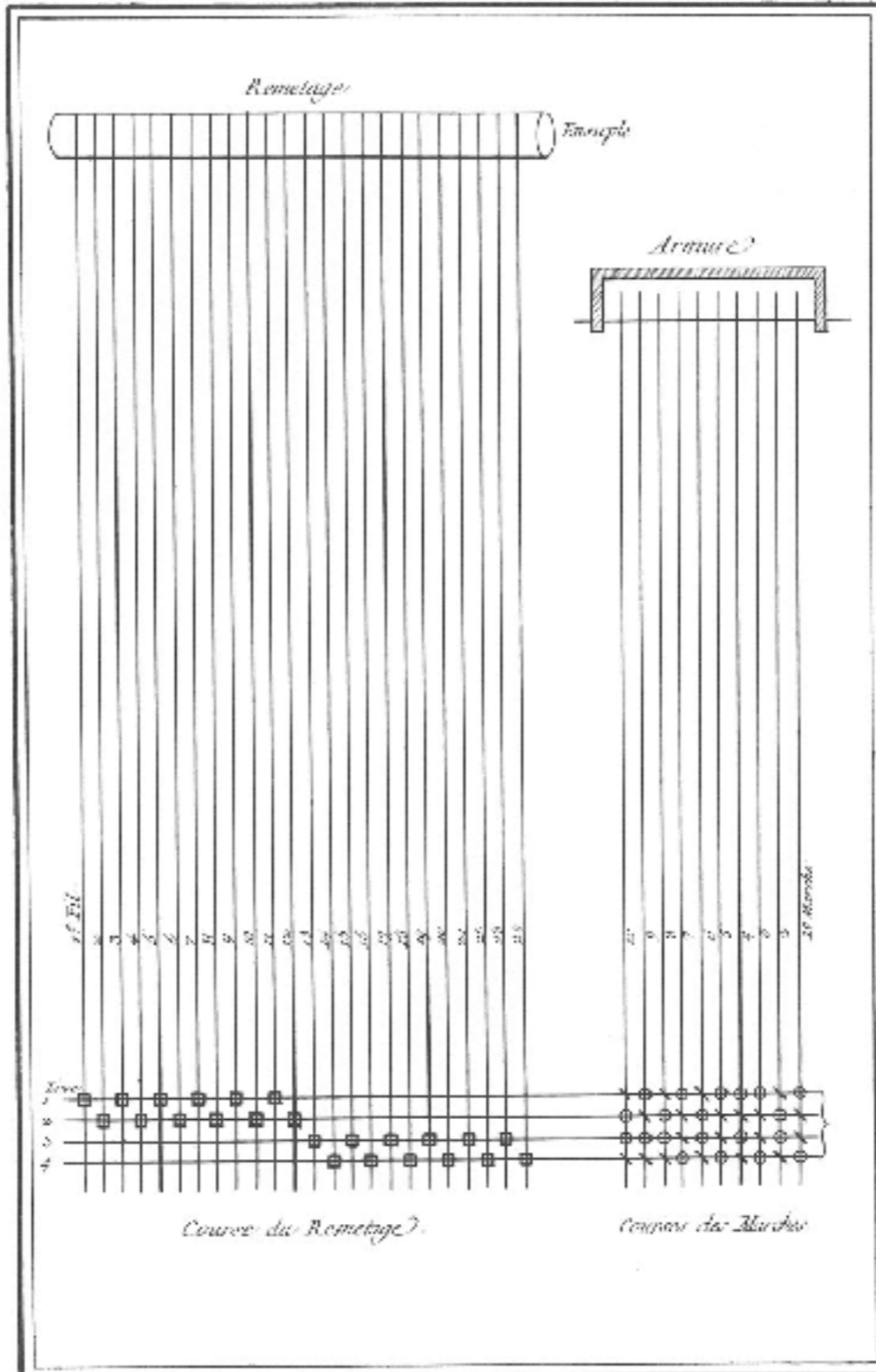

Source: 101

Source: 101

Soierie,

Chagrin ou Siamoise pour faire la Paillote plus large.

“Soierie, ...”

The Encyclopedia of Diderot & d'Alembert 1763  
(University of Michigan)

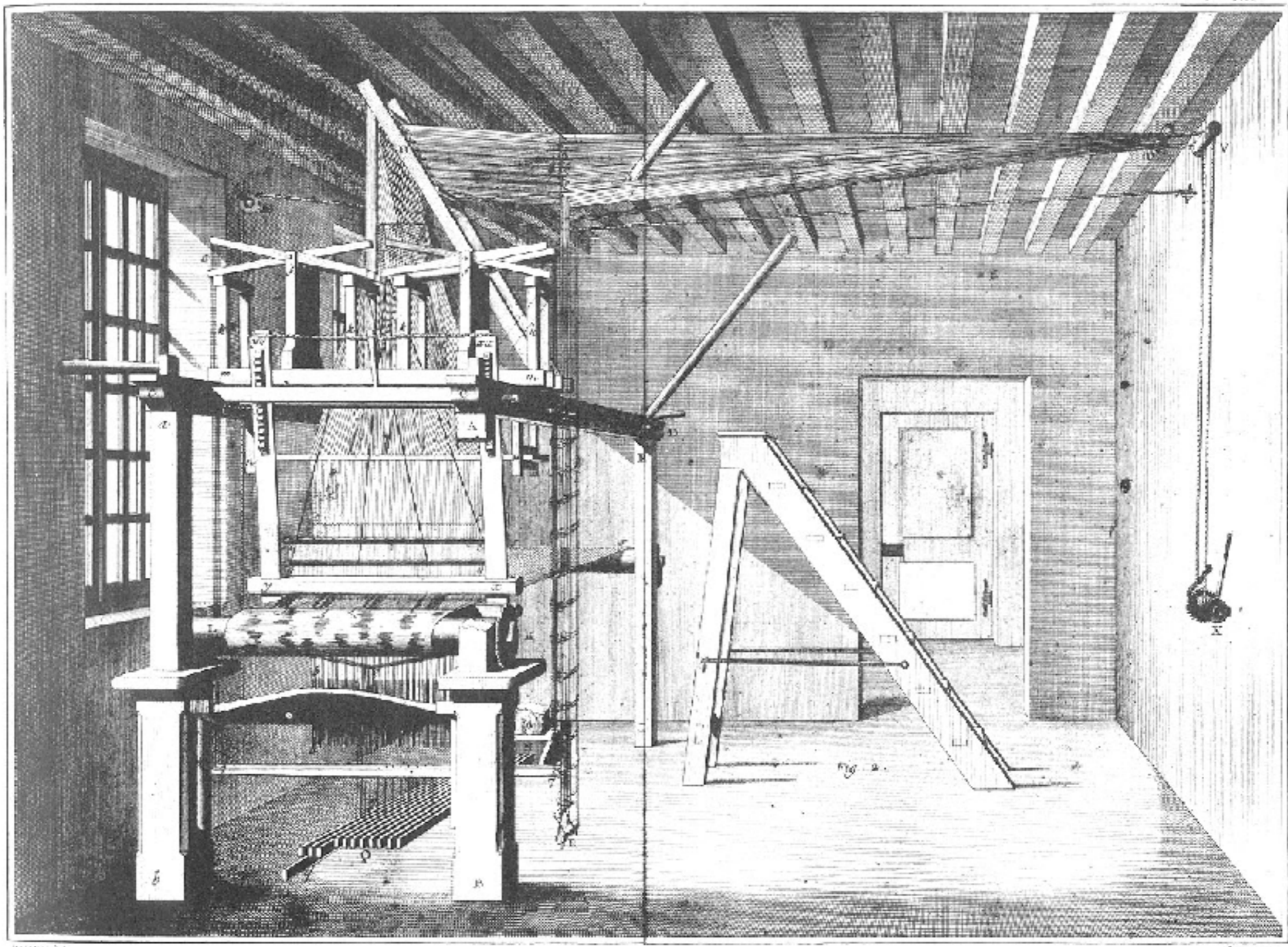

*Soierie, Truffes Brochées élévation Perspective du Méier pour filer que les Truffes Brochées garni de tous les cylindres et autres*

“Soierie, ...”

The Encyclopedia of Diderot & d'Alembert 1763  
(University of Michigan)

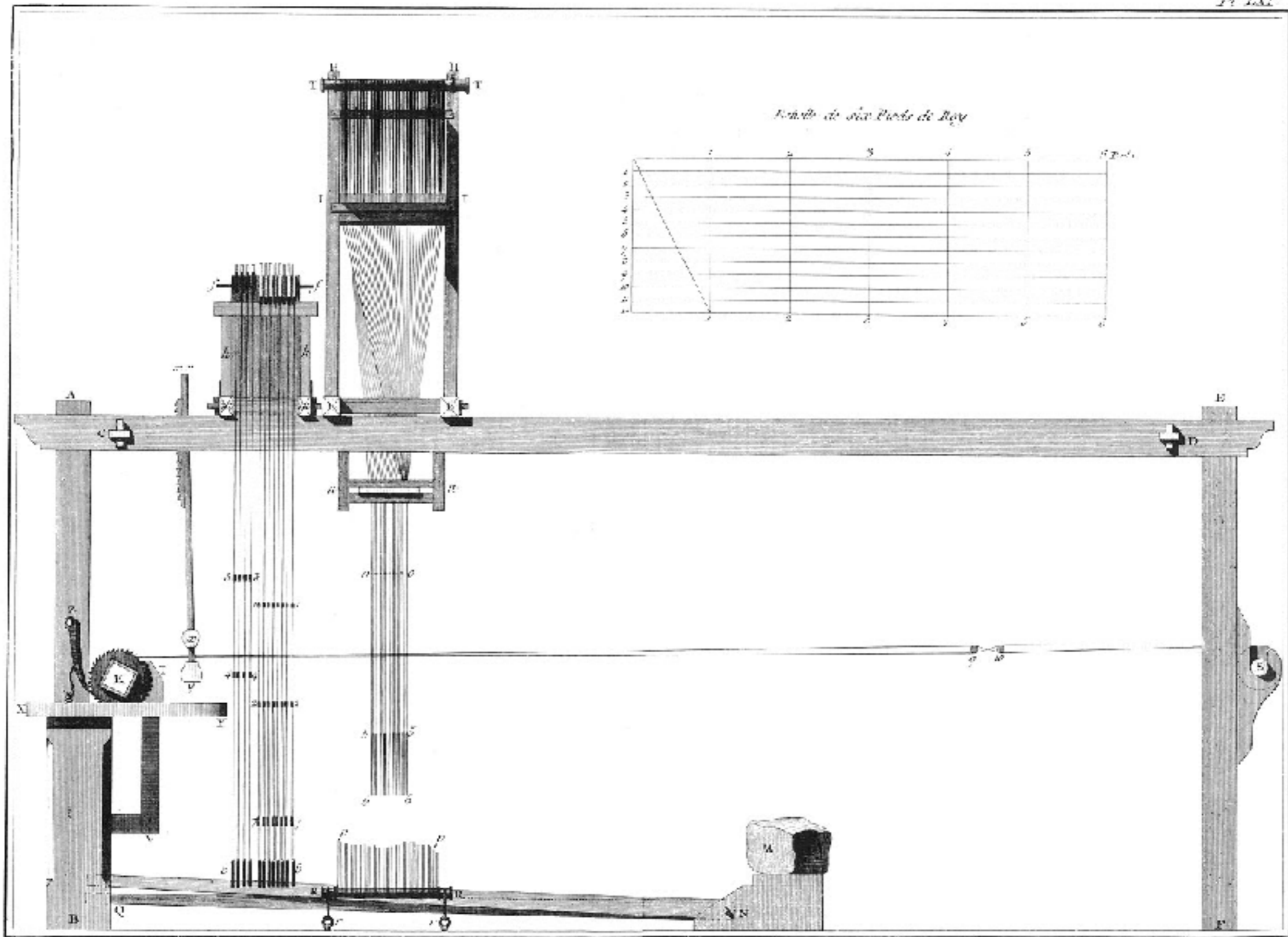

*Soierie; Étoffes Brochées. Élévation Latérale du Métier pour fabriquer les Étoffes Brochées.*

P

“Soierie, ...”

The Encyclopedia of Diderot & d'Alembert 1763  
(University of Michigan)

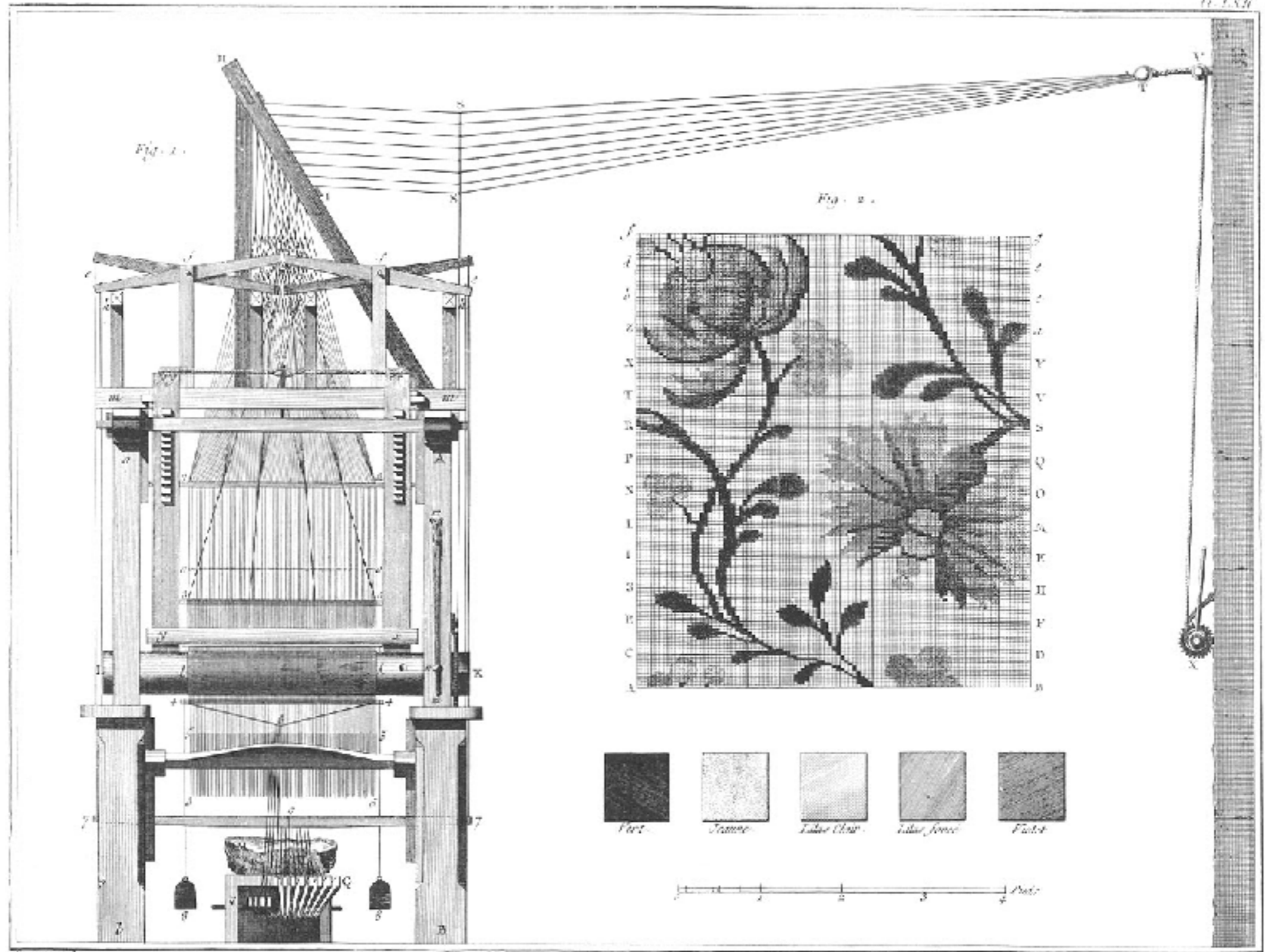

Benard del.

Benard fecit.

*Soierie, Étoffes Brochées, Élévation Géométrale du devant du Méier pour fabriquer les Étoffes Brochées.*

“Soierie, ...”

The Encyclopedia of Diderot & d'Alembert 1763  
(University of Michigan)

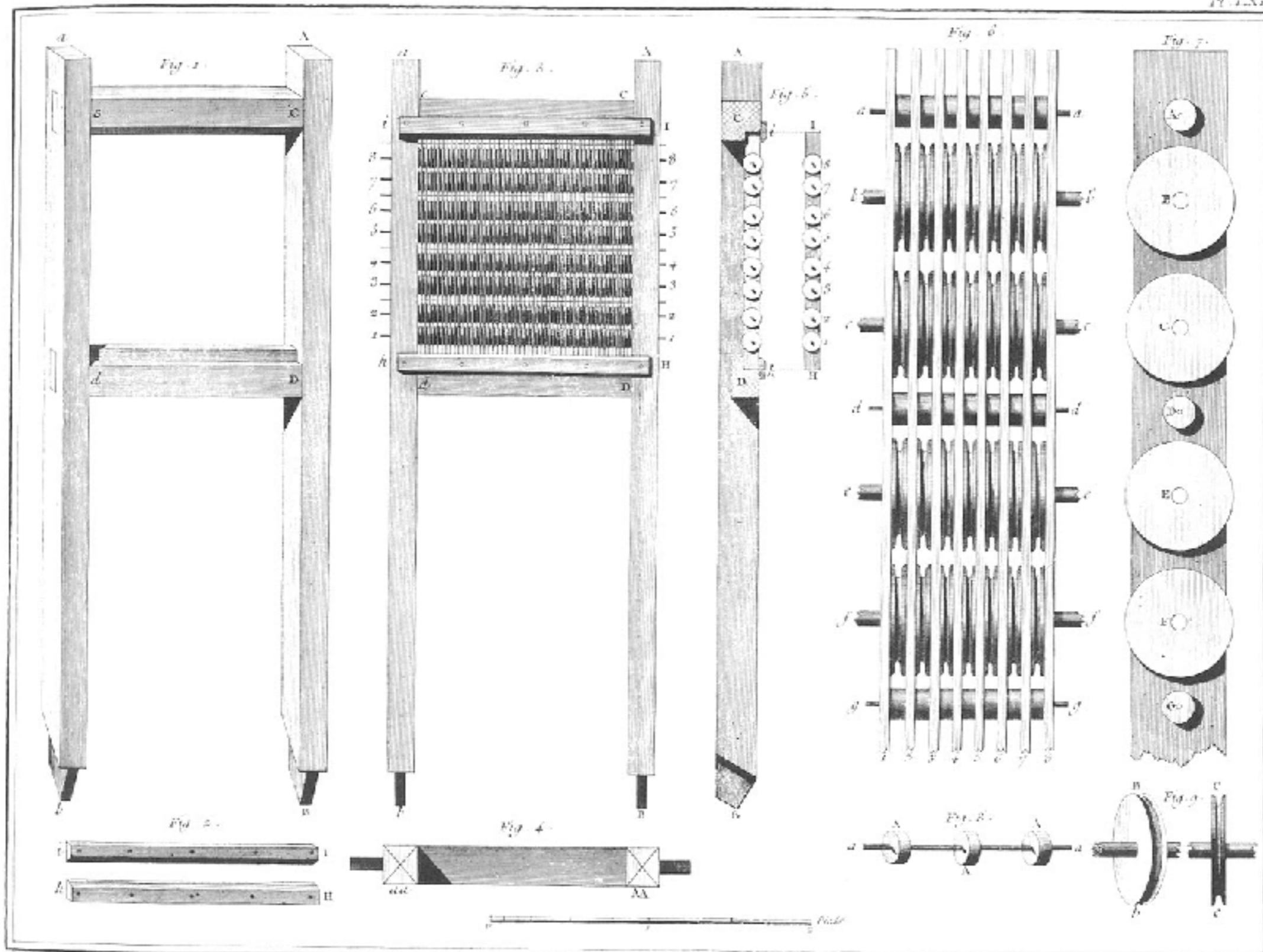

Soierie, Étoffe Brochiée, Élévation et Développement du Cassin.

“Soierie, ...”

The Encyclopedia of Diderot & d'Alembert 1763  
(University of Michigan)

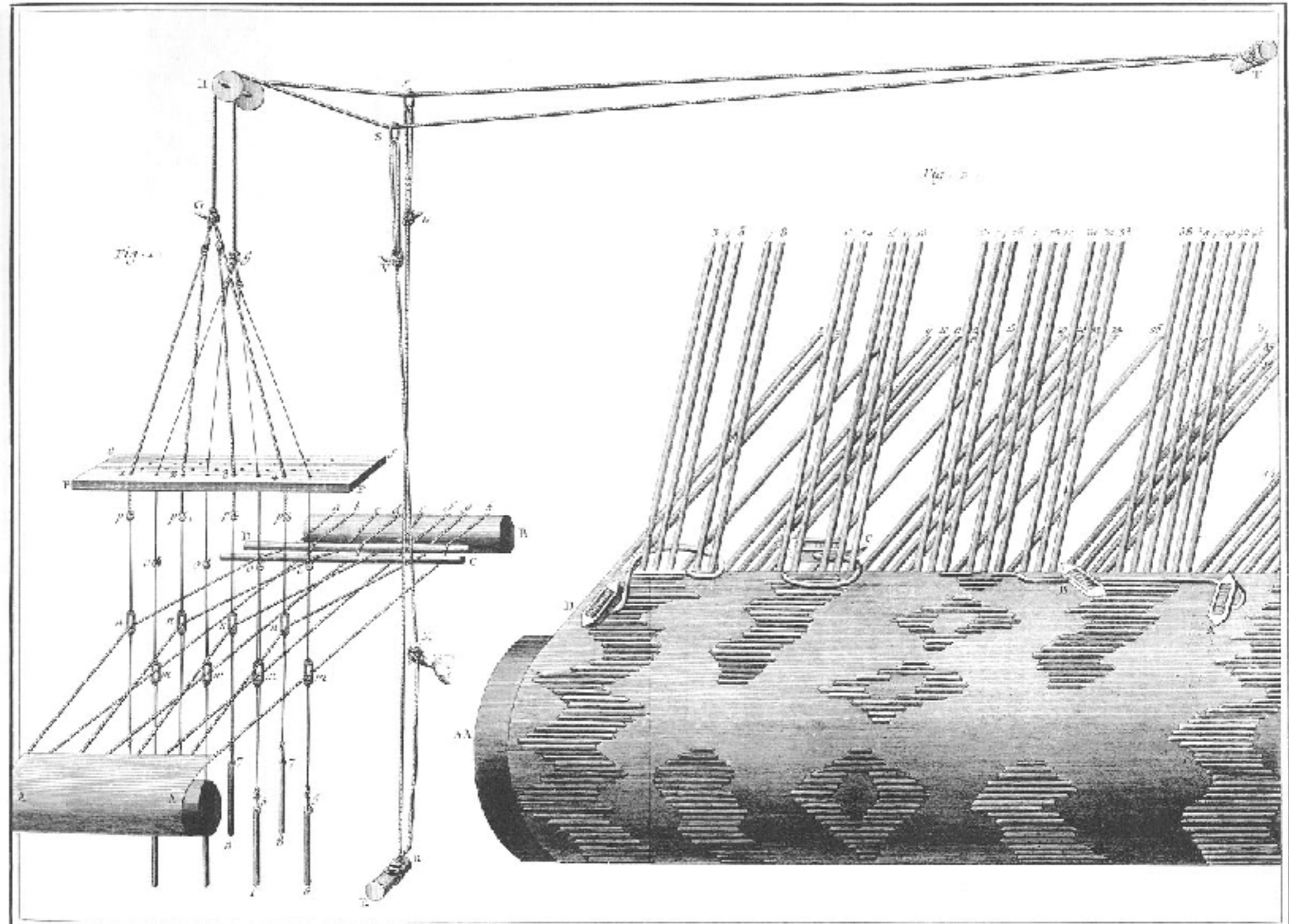

*Soierie, Développement des Cordes de Ramme et de Sample et leur action sur les Vils de la Chaîne des Étoffes Brochées ou le Poil des Velours frizés et Coupés. Partie d'Étoffe Brochée Vue du côté de l'envers et au microscope.*

“Soierie, ...”

The Encyclopedia of Diderot & d'Alembert 1763  
(University of Michigan)

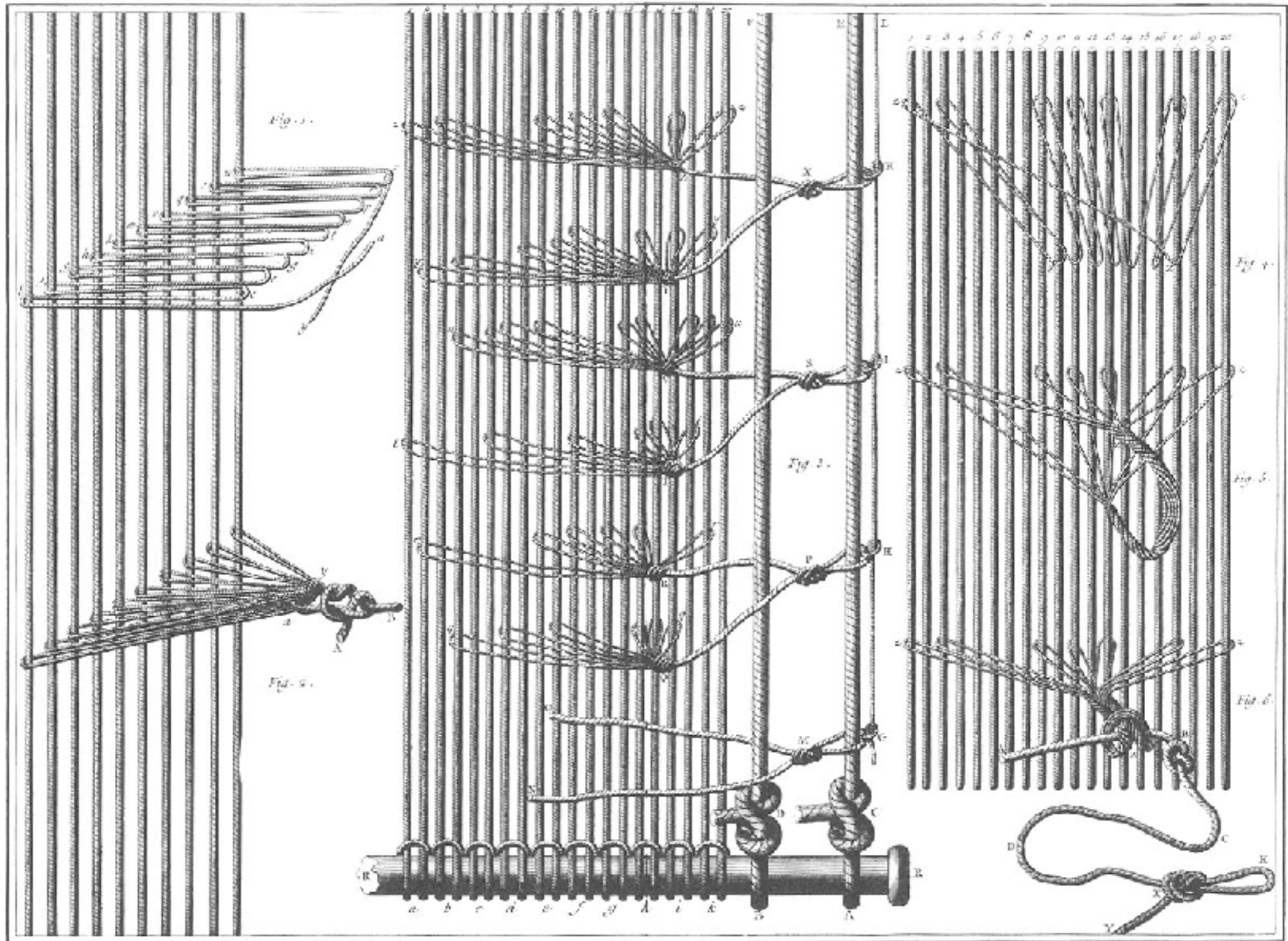

De la Haye Del.

Benard Sculp.

*Soierie, Lacqs. Lacq à l'Angloise, Lacqs du Simple, Cavassine et formation d'un Lacq.*

U

“Soierie, ...”

The Encyclopedia of Diderot & d'Alembert 1763  
(University of Michigan)

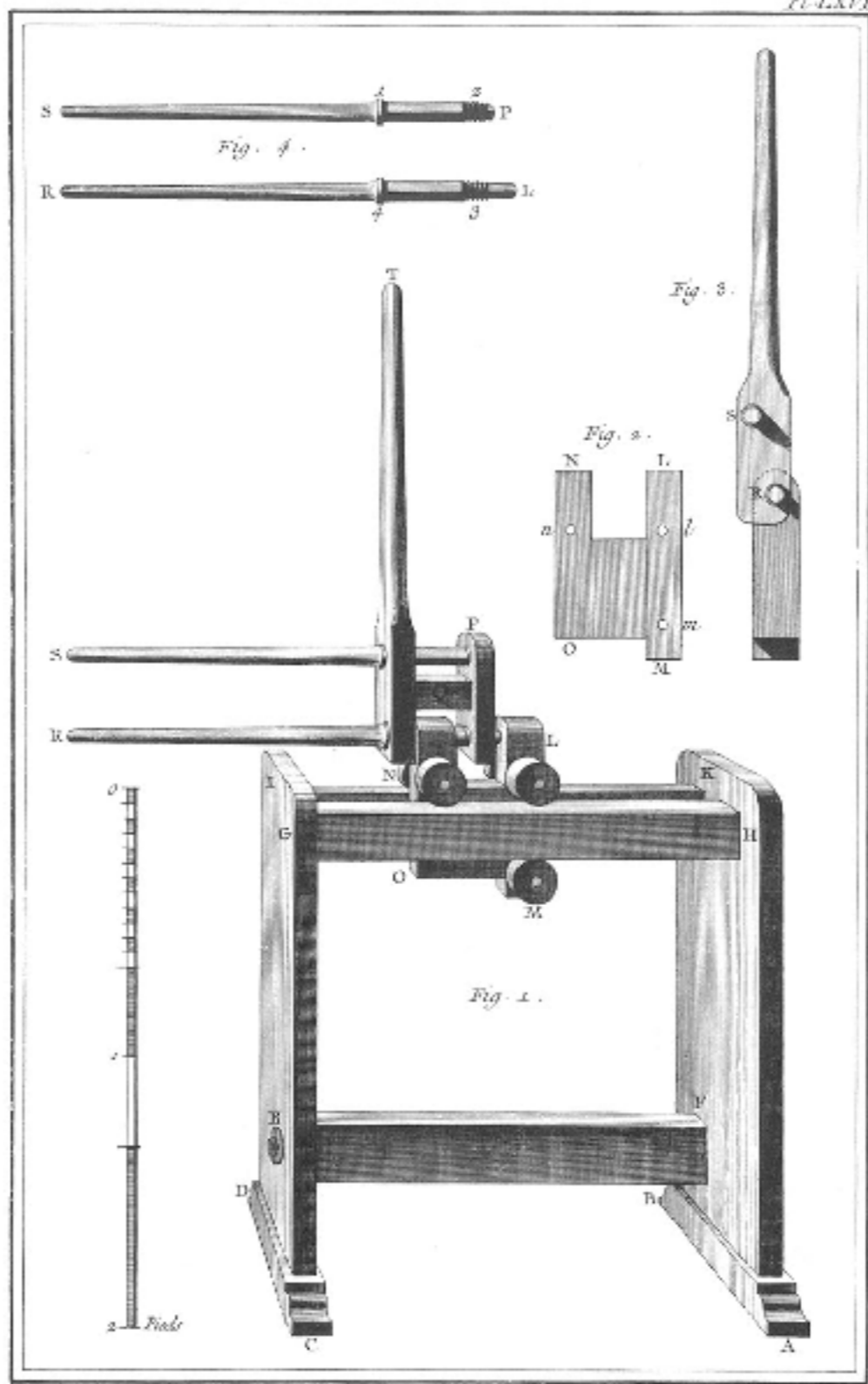

Benard Del. Benard Sculp.

Soierie, construction de la Machine pour la Tire. W

“Soierie, ...”

The Encyclopedia of Diderot & d'Alembert 1763 (University of Michigan)

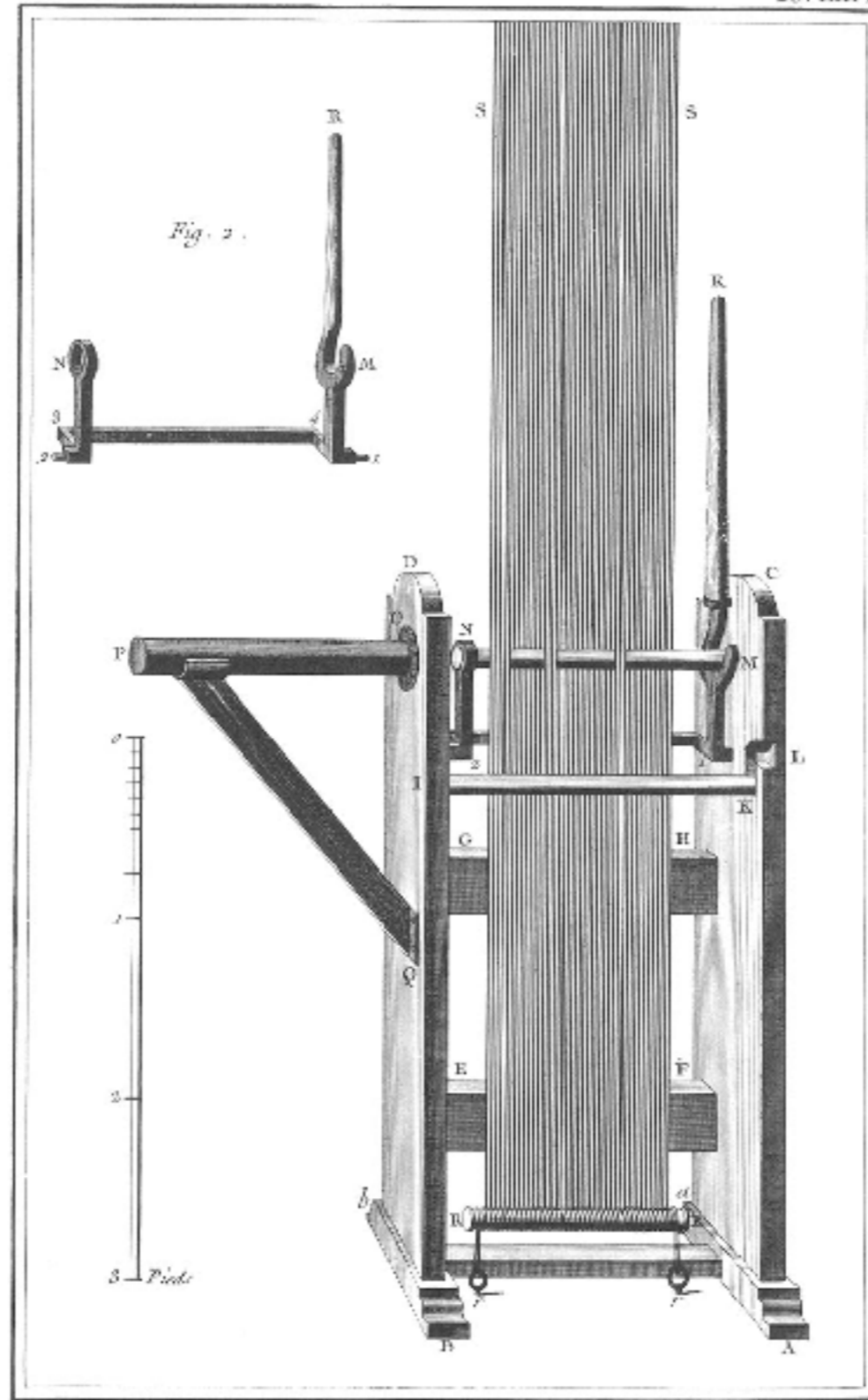

*Soierie, Nouvelle Machine pour la Tirc.*

“Soierie, ...”

The Encyclopedia of Diderot & d'Alembert 1763  
(University of Michigan)

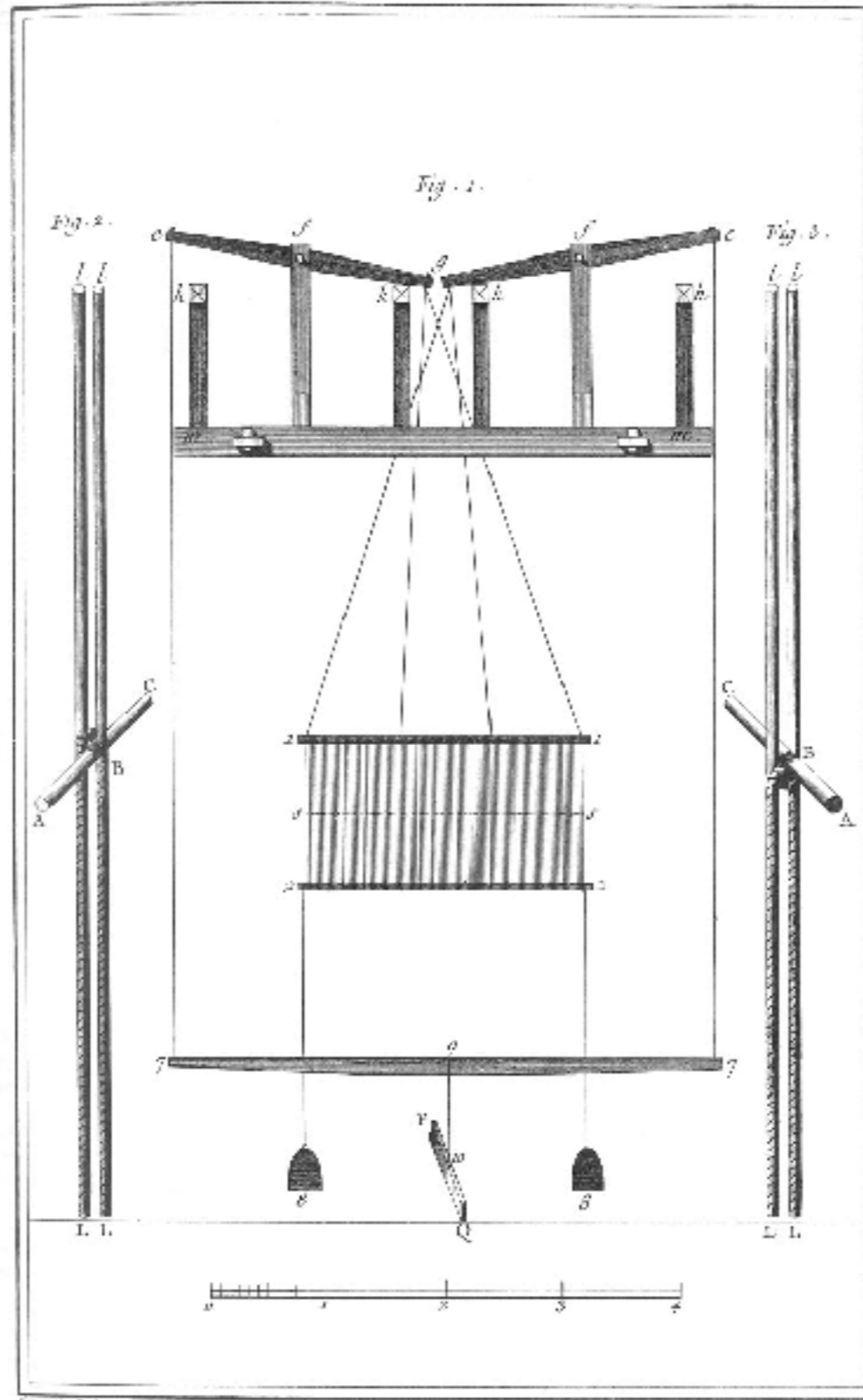

Soierie, Étoffe Brochée Développement des Tuteurs de fond.

“Soierie, ...”

The Encyclopedia of Diderot & d'Alembert 1763  
(University of Michigan)

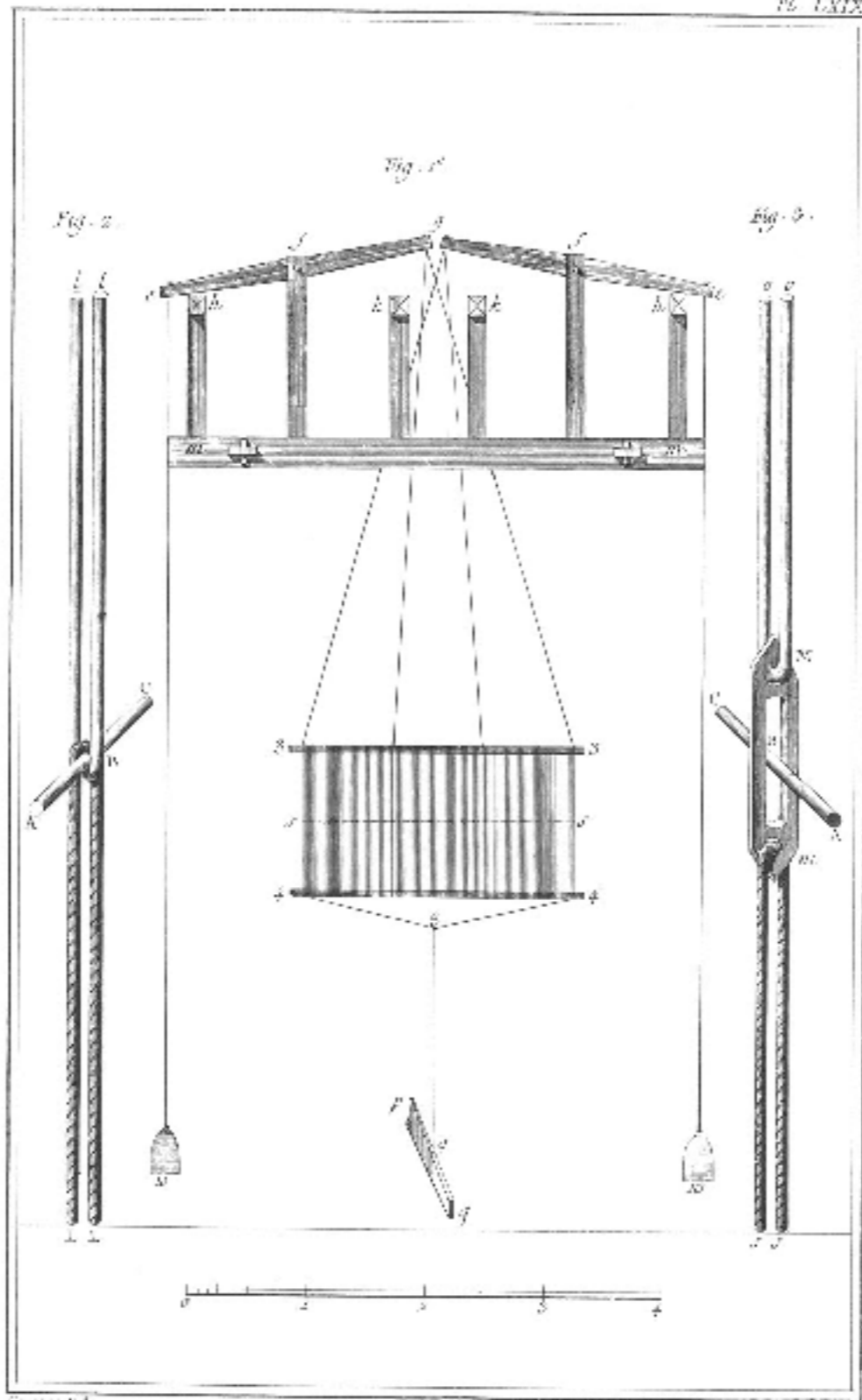

*Soierie, Stoffes Brochés. Développement des Trains de Laine.*

“Soierie, ...”

The Encyclopedia of Diderot & d'Alembert 1763  
(University of Michigan)

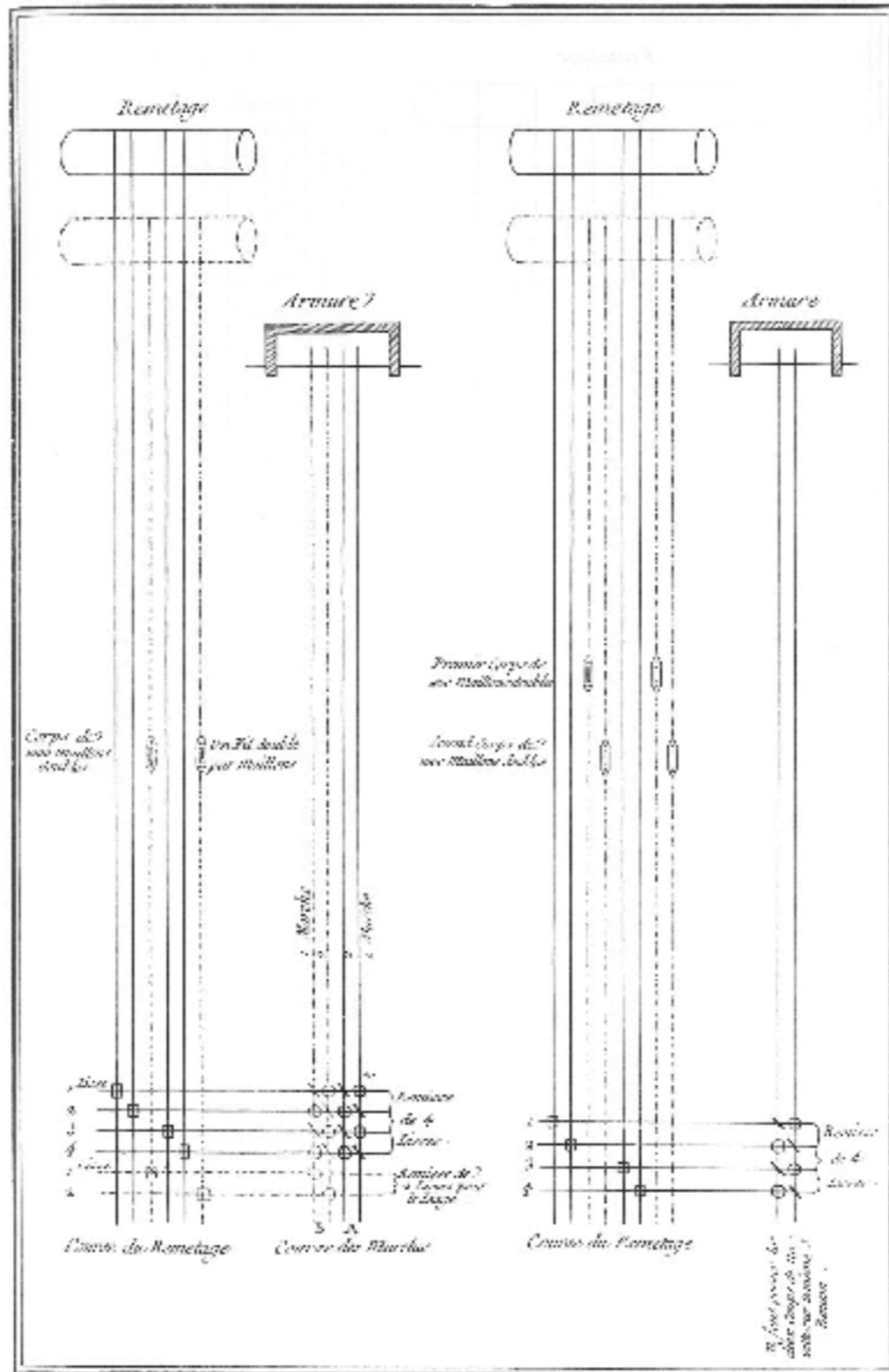

Soierie,  
Taffetas Façoné Simple et Taffetas Façoné Doubleté. ca

“Soierie, ...”

The Encyclopedia of Diderot & d'Alembert 1763  
(University of Michigan)

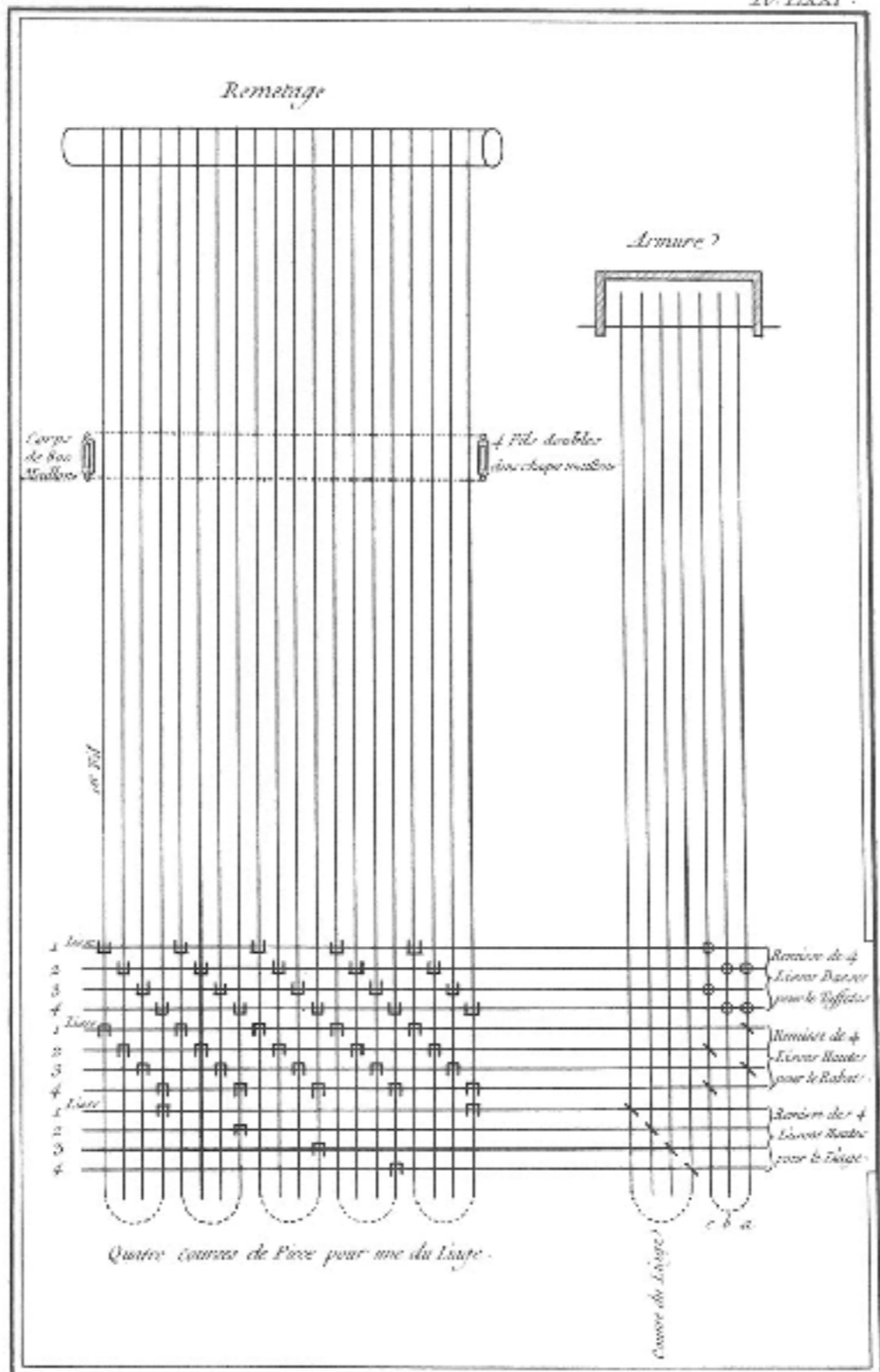

Boissier Del.

Benard Scul.

*Soierie*,  
*Tiffetis Broché et Lizéré avec un Linge de 3 le 4.* bb

“Soierie, ...”

The Encyclopedia of Diderot & d'Alembert 1763  
(University of Michigan)

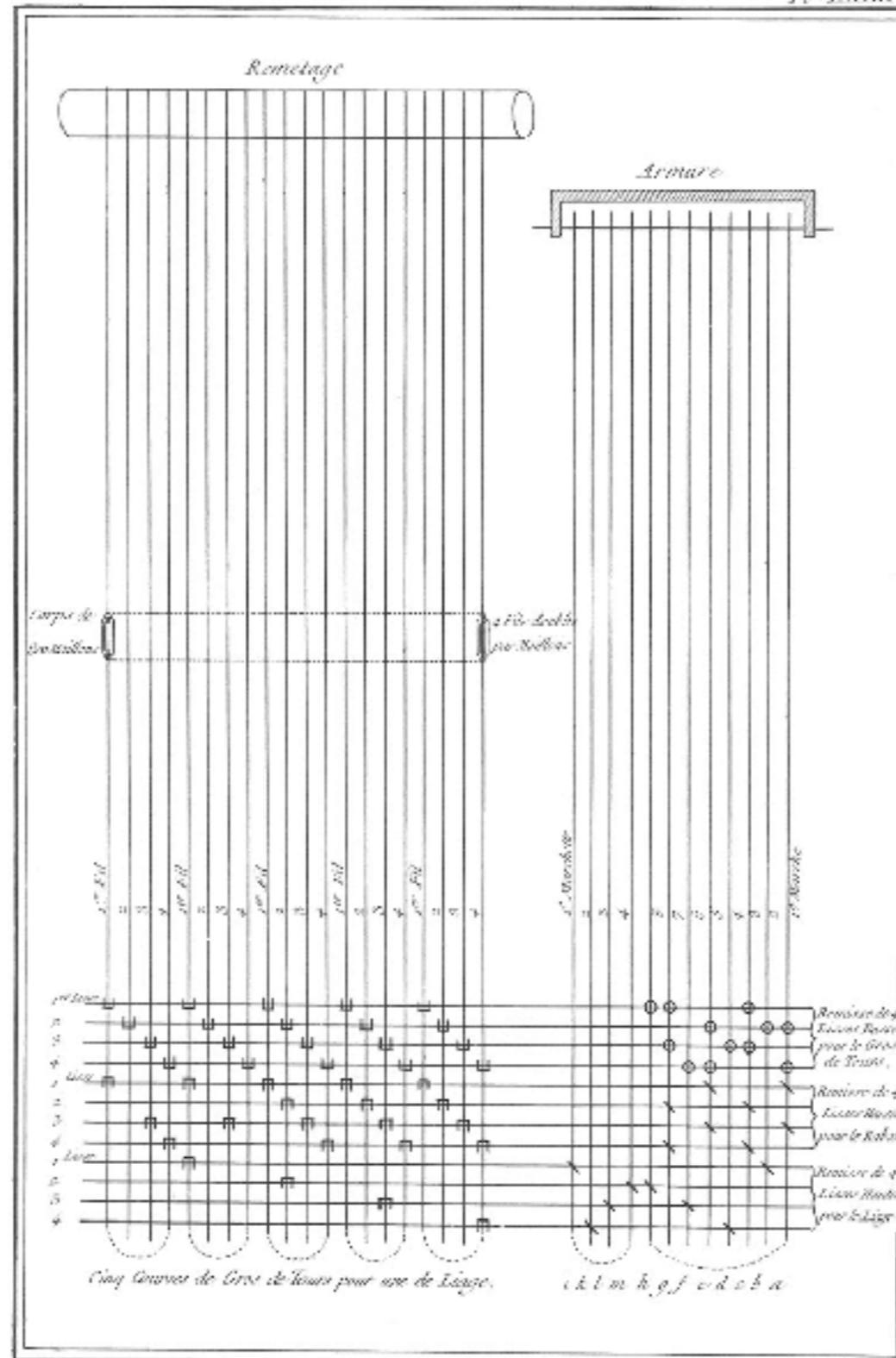

Benard Del. Benard Fecit.

Soierie,

Gros de Tours Lizéré et Broché avec un Liège de 4 le 5. CC

“Soierie, ...”

The Encyclopedia of Diderot & d'Alembert 1763 (University of Michigan)

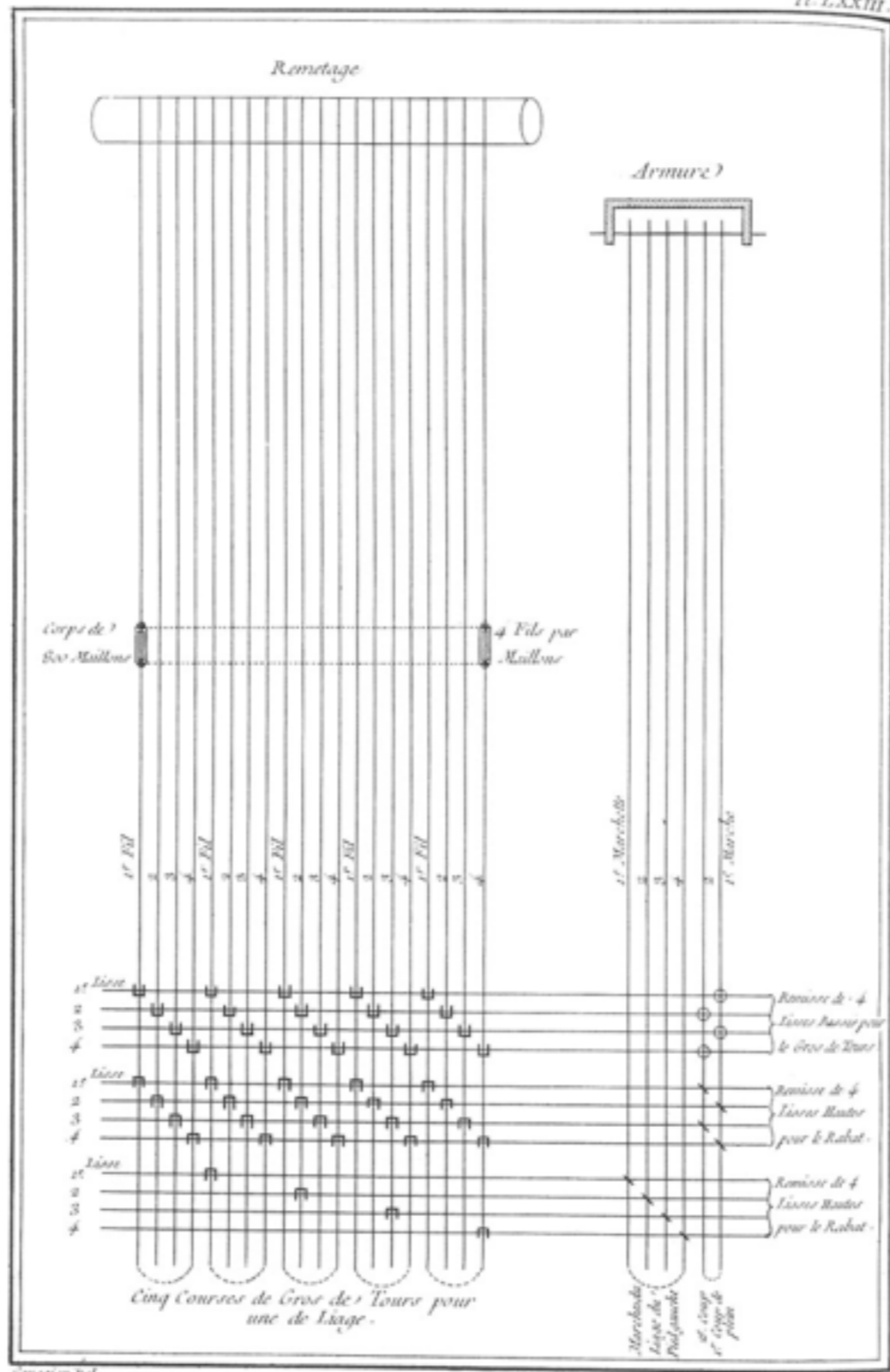

*Soierie*,  
*Gros de Tours Broché avec un Liège de 4 le 5.* dd

“Soierie, ...”

The Encyclopedia of Diderot & d'Alembert 1763  
 (University of Michigan)

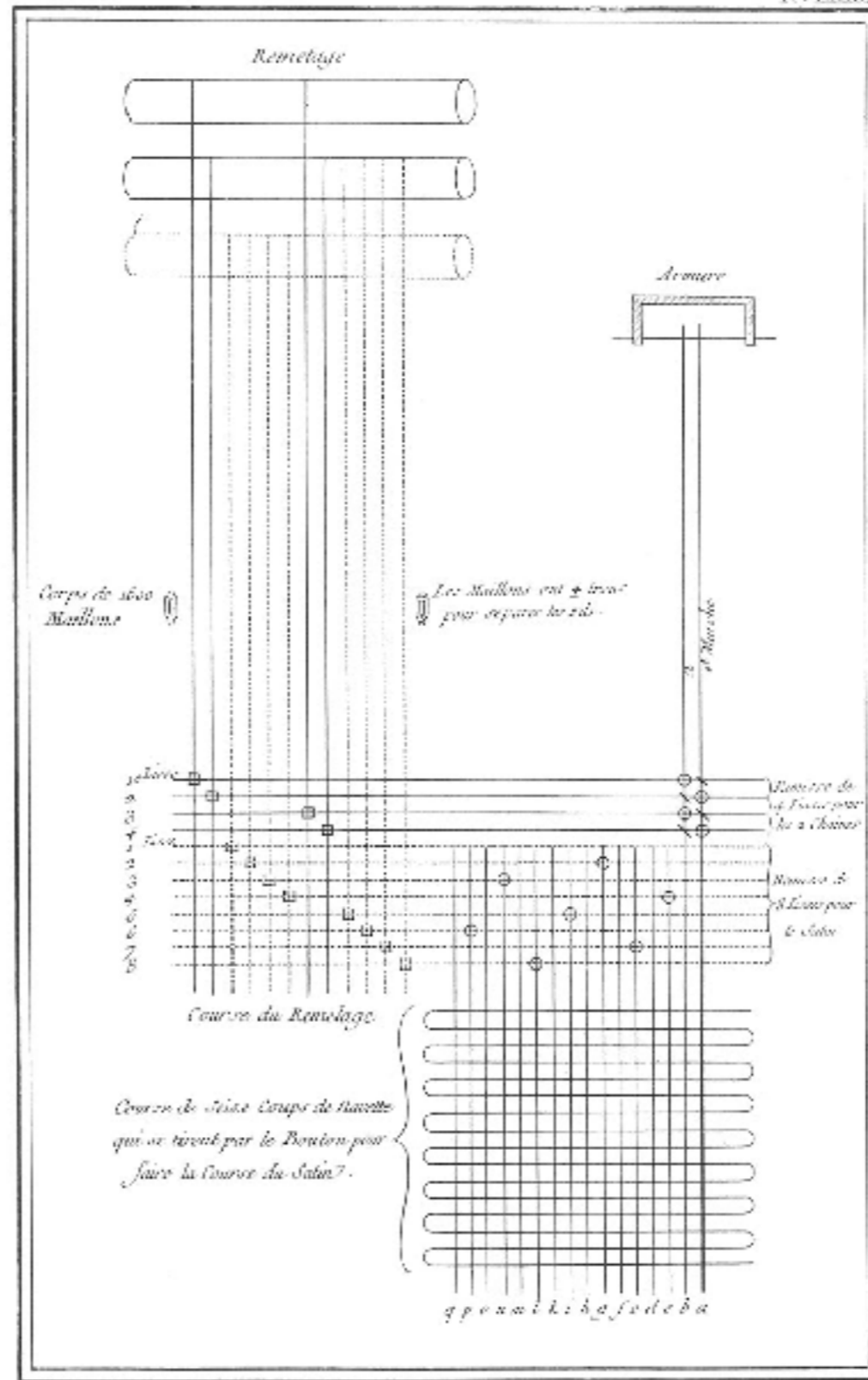

Dessiné par Del.

Gravé par Boit.

Soierie, Droguet Satiné.

ee

“Soierie, ...”

The Encyclopedia of Diderot & d'Alembert 1763 (University of Michigan)

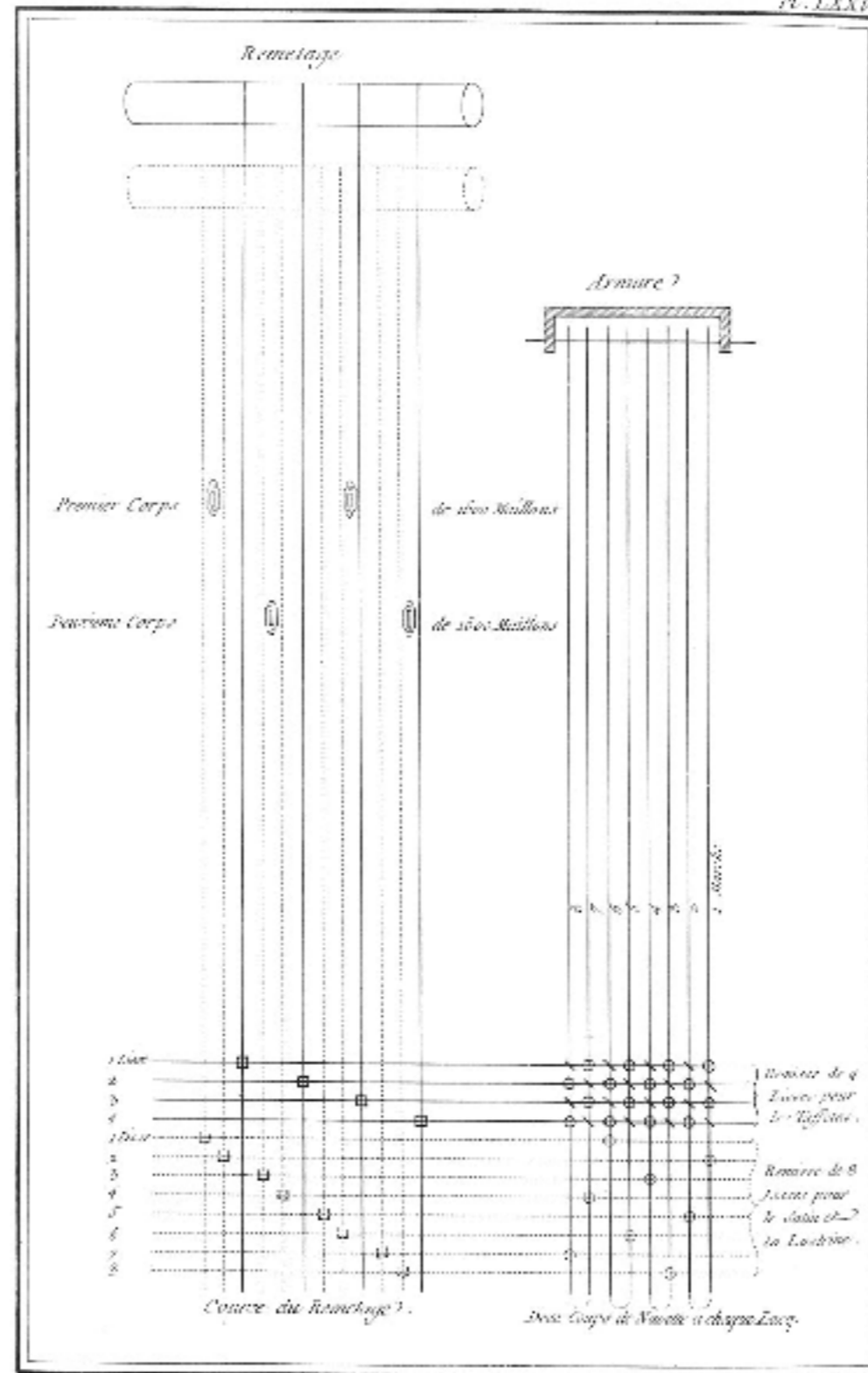

Soierie,  
Drognet Lustriné Double Corps.

“Soierie, ...”

The Encyclopedia of Diderot & d'Alembert 1763  
(University of Michigan)

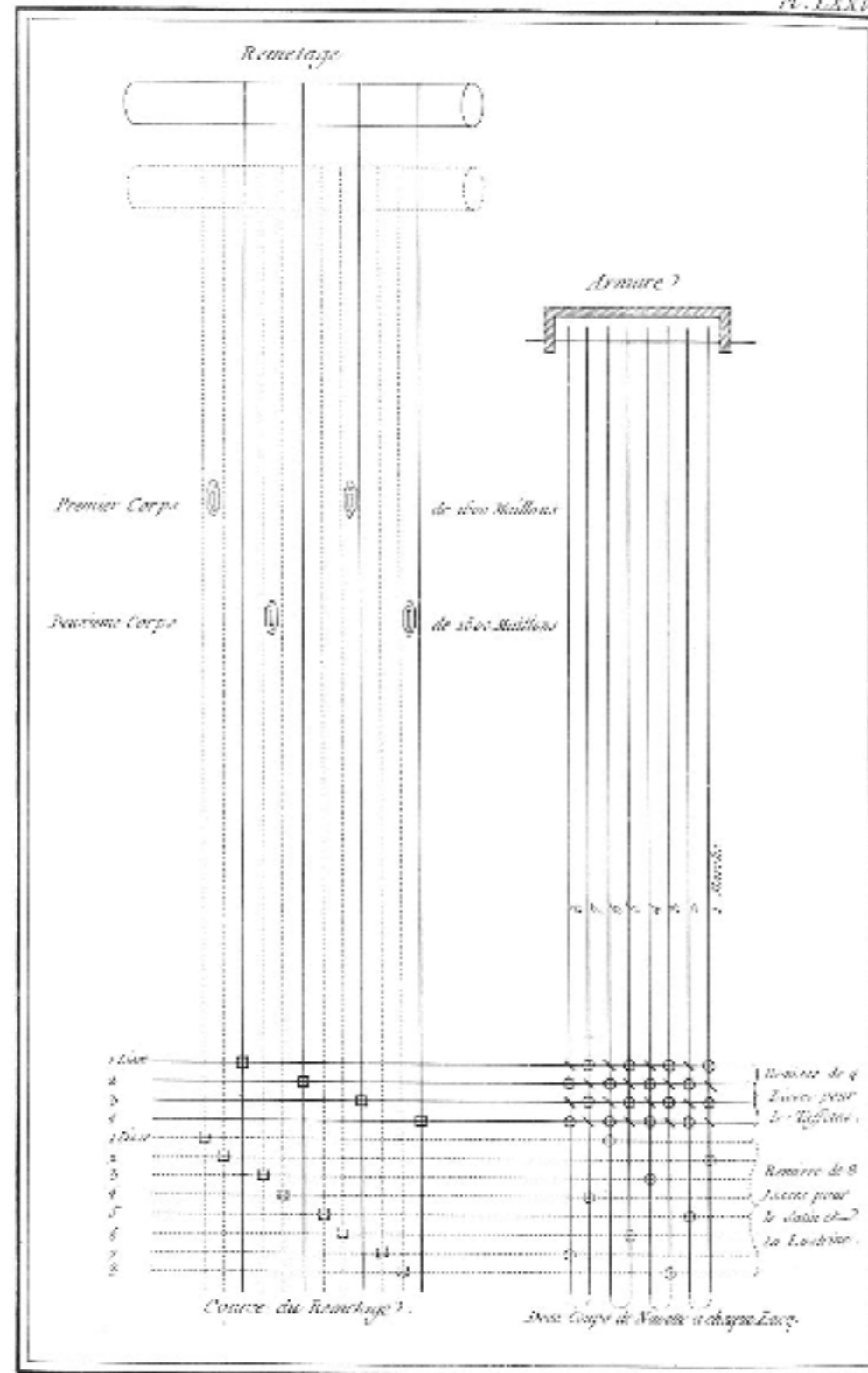

Soierie,  
Drognet Lustriné Double Corps.

“Soierie, ...”

The Encyclopedia of Diderot & d'Alembert 1763  
(University of Michigan)

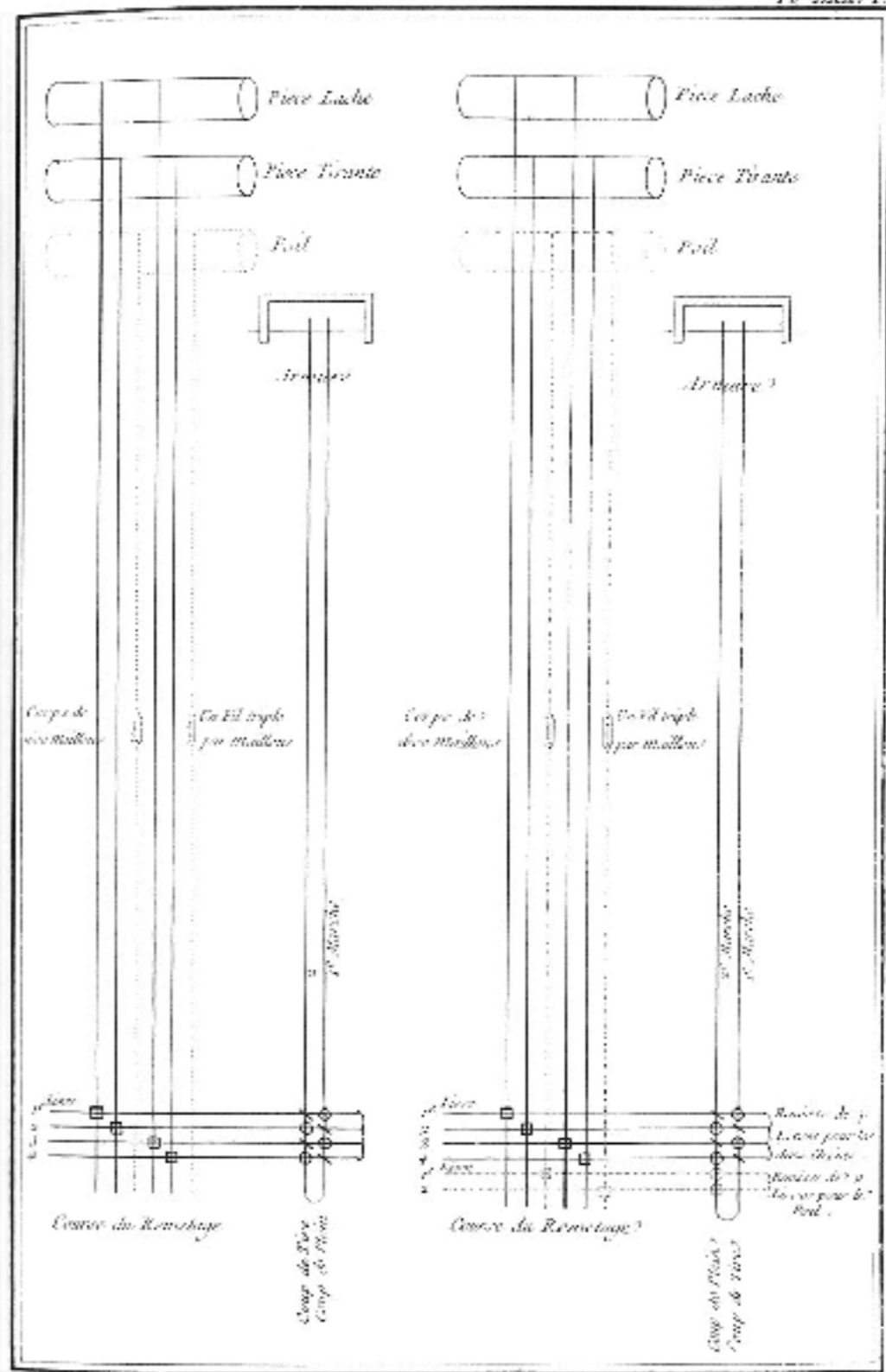

*Soierie,*  
*Droquet Lucoise: autre Droquet Lucoise: l'Endroit dessus.* 99

“Soierie, ...”

The Encyclopedia of Diderot & d'Alembert 1763  
 (University of Michigan)

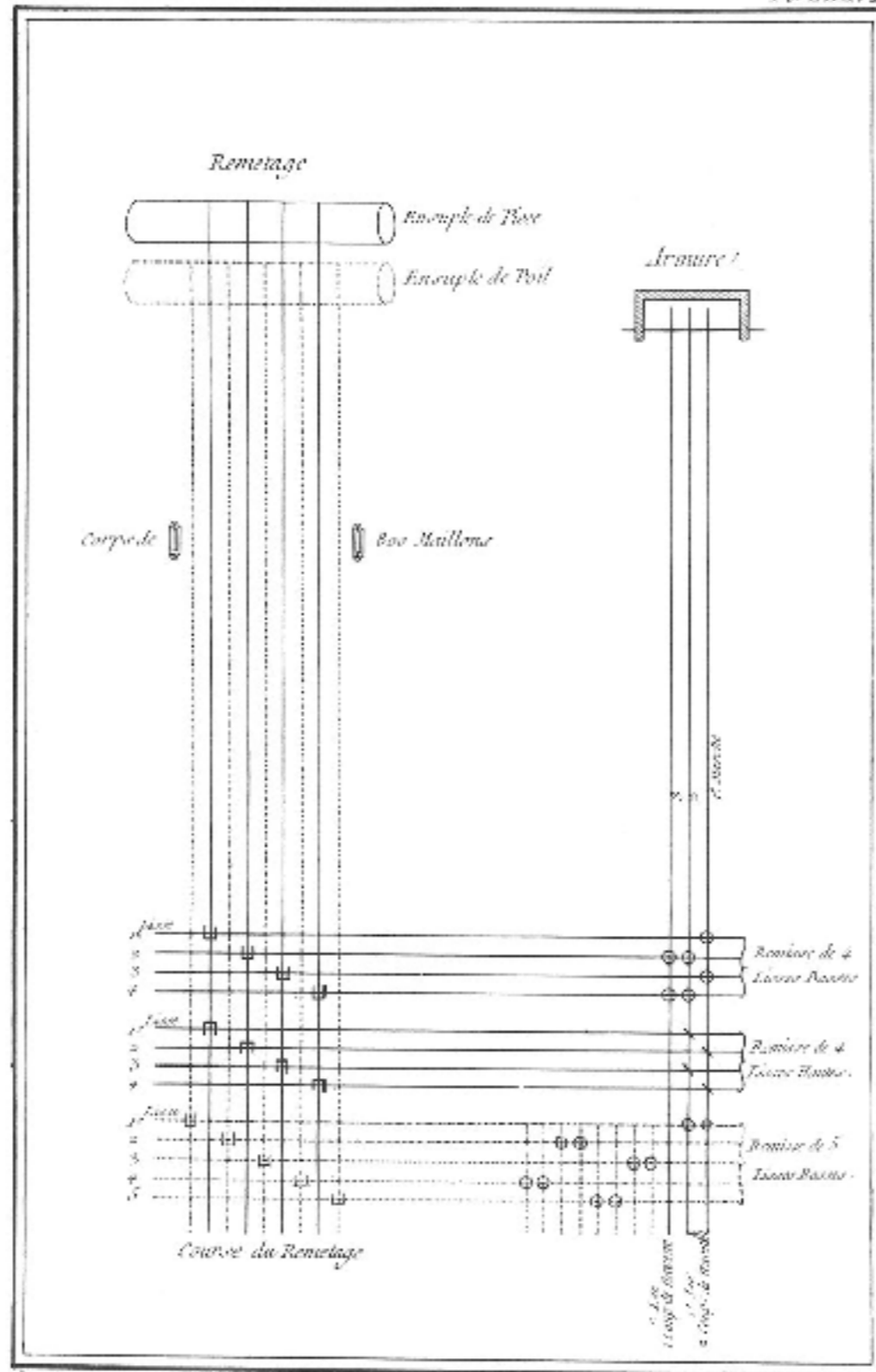

Construit par...

Revisé par...

*Soierie, Espece de Perruque Lizerie.*

hlc

“Soierie, ...”

The Encyclopedia of Diderot & d'Alembert 1763  
(University of Michigan)

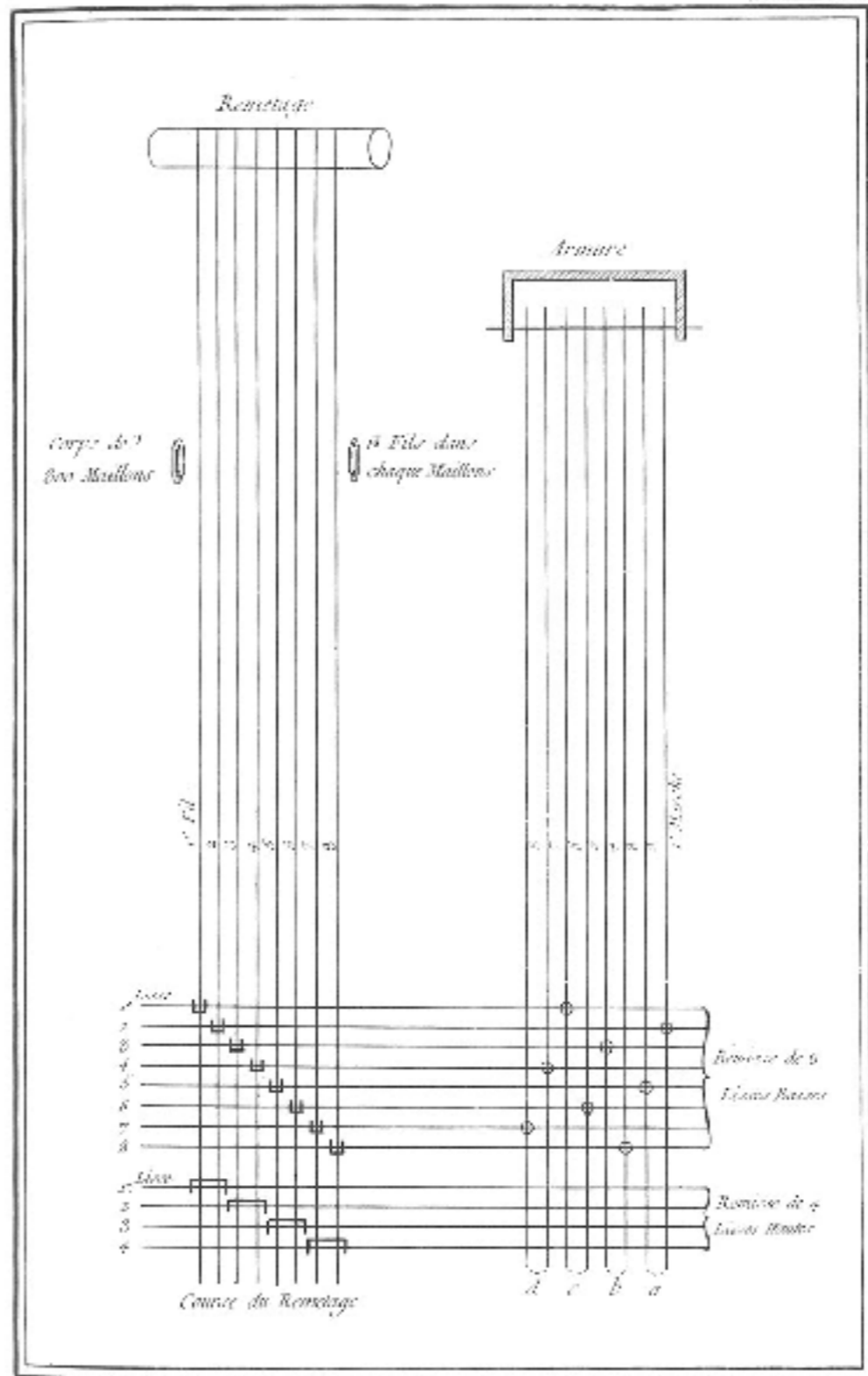

Encour. Tot.

Encour. Tot.

### Soierie.

Lustrine courante .si on veut du Lizeré mettez un Liège de 5 le 6, ou de 9 le 10 .

“Soierie, ...”

The Encyclopedia of Diderot & d'Alembert 1763  
(University of Michigan)

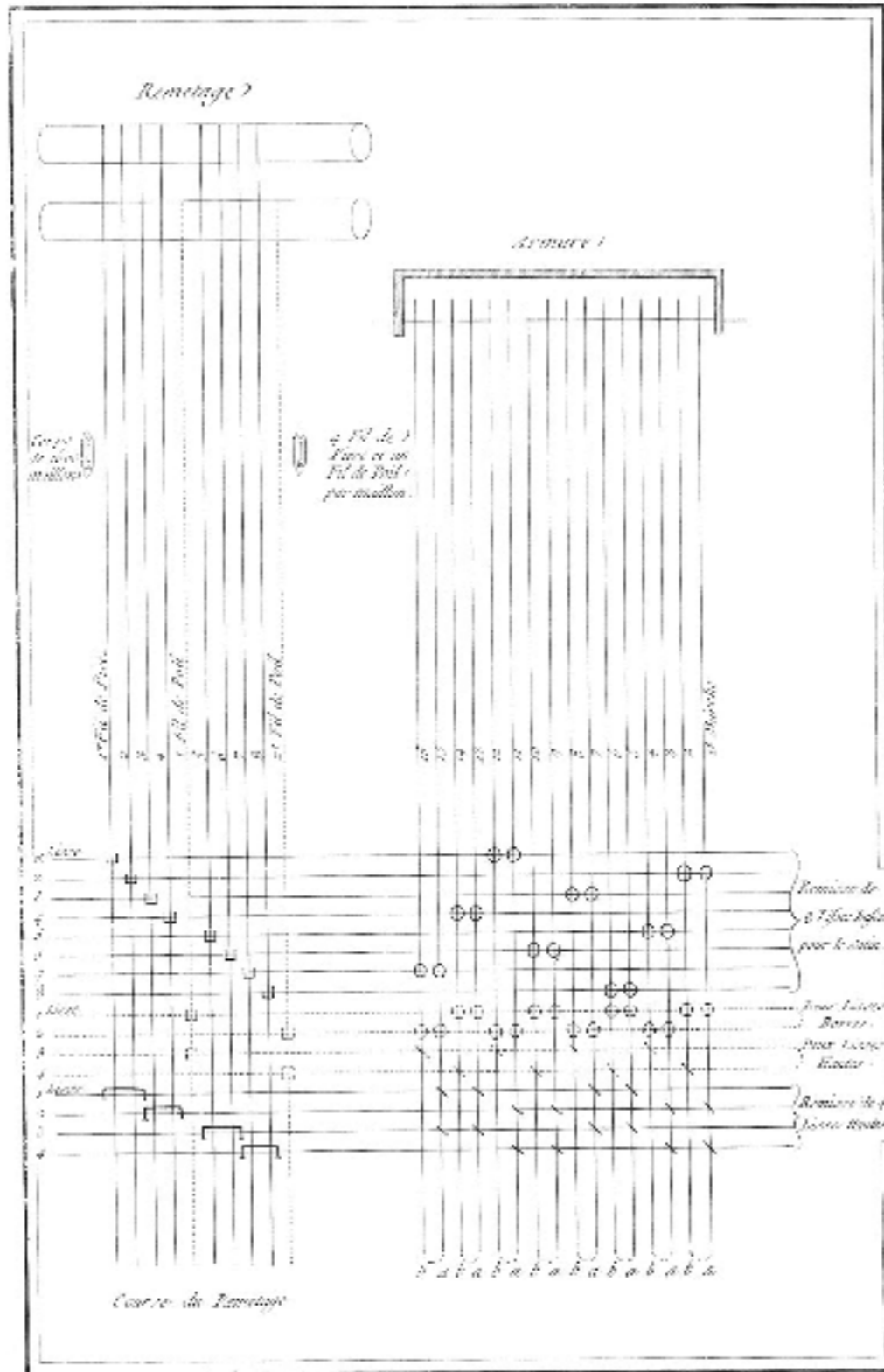

Plancher de

à fil de 1 à fil de 10

*Soierie,*  
*Lastrine Gros Grain et Perlemme Petit Grain.*

kk

“Soierie, ...”

The Encyclopedia of Diderot & d'Alembert 1763  
(University of Michigan)

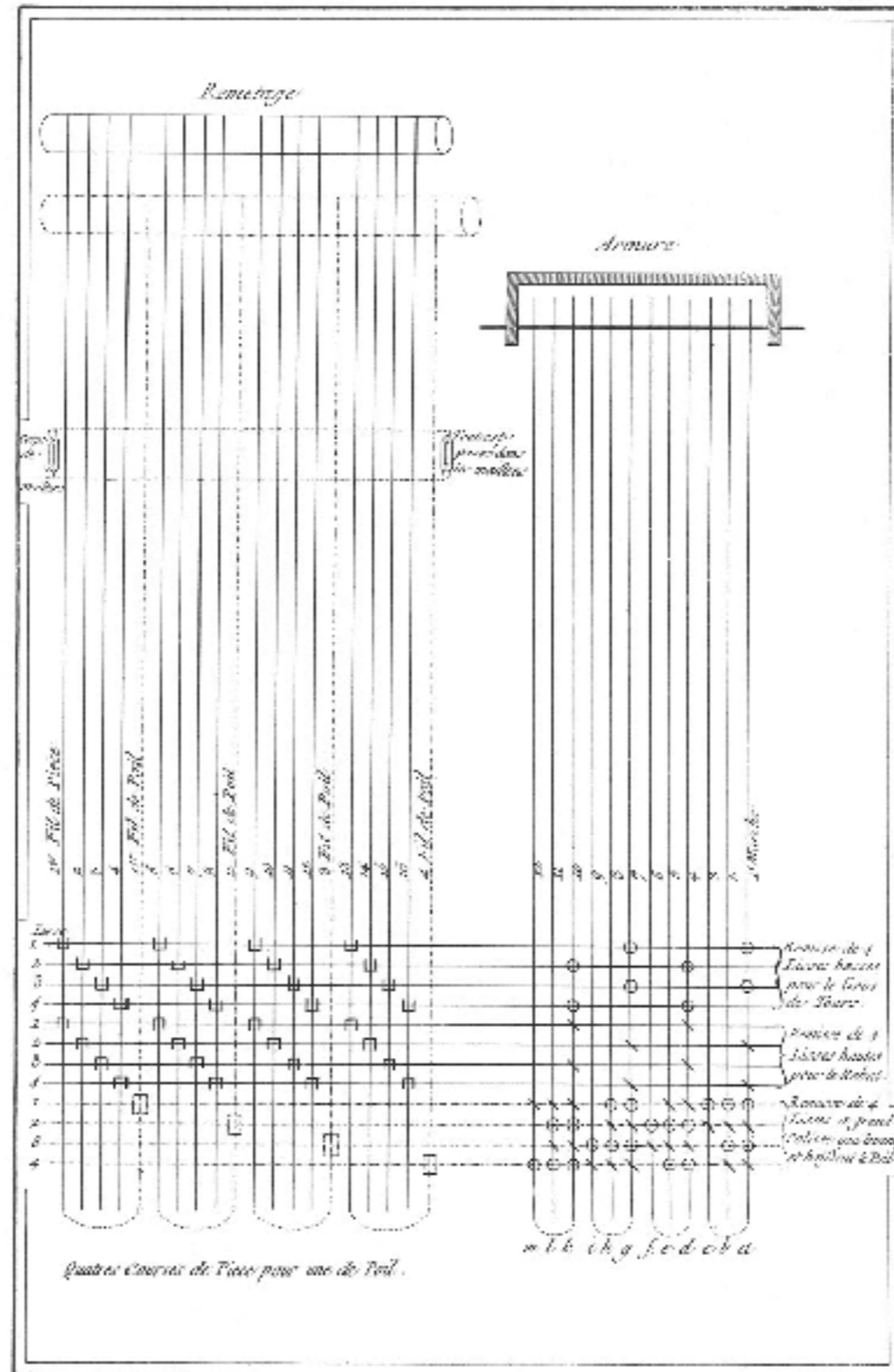

Leveur Sol.

Arrière Sol.

### Soierie,

Tissu Argent, l'endroit se fait dessous.

“Soierie, ...”

The Encyclopedia of Diderot & d'Alembert 1763  
(University of Michigan)

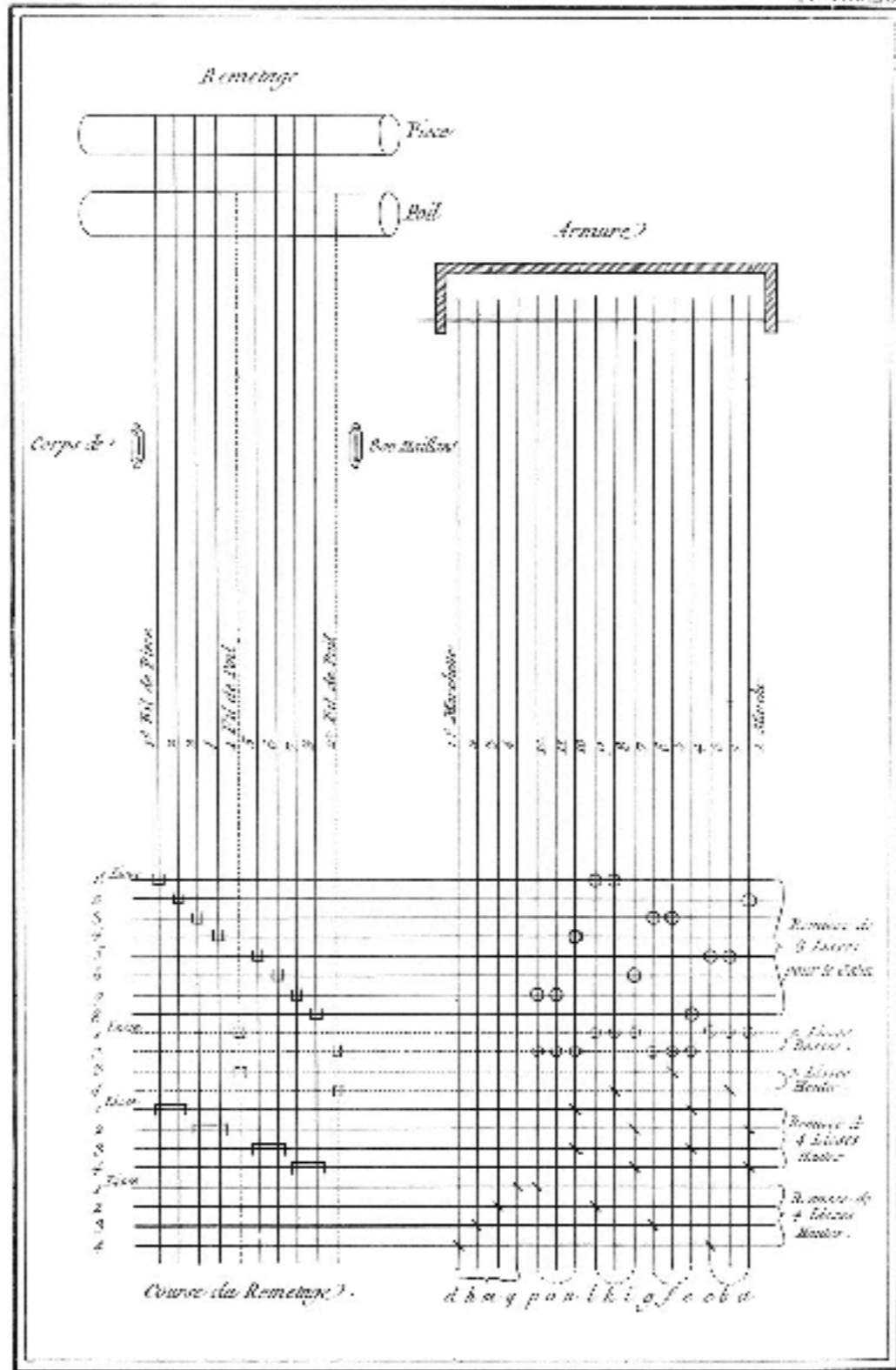

Dessiné par

Gravé par

*Soierie,*  
*Lustrine et Persienne Lixérée et Brochie.*

MMV

“Soierie, ...”

The Encyclopedia of Diderot & d'Alembert 1763  
 (University of Michigan)

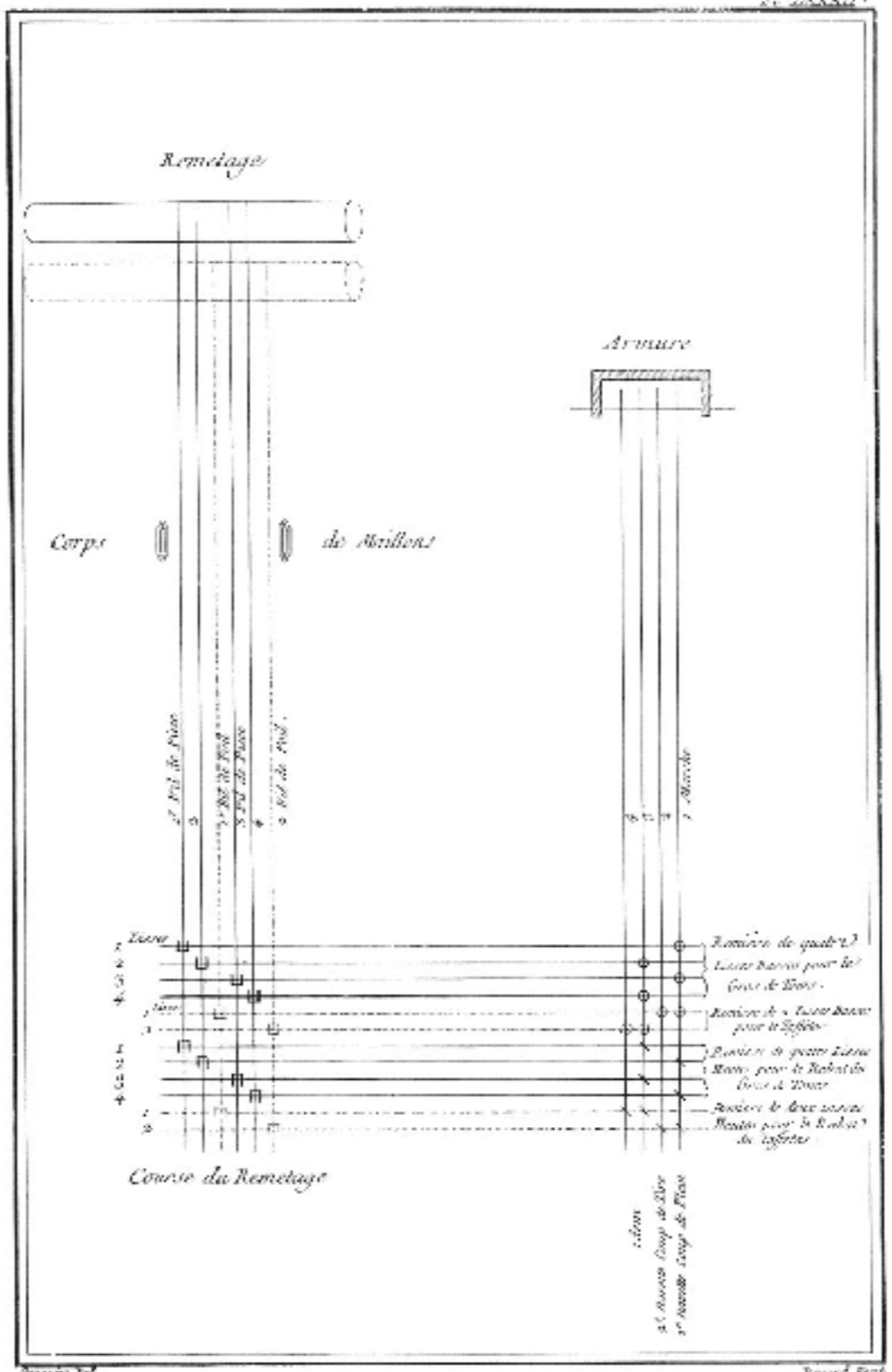

Debord del.

Boyer fecit.

Soierie, Baz de Sicile courant.

111

“Soierie, ...”

The Encyclopedia of Diderot & d'Alembert 1763  
(University of Michigan)

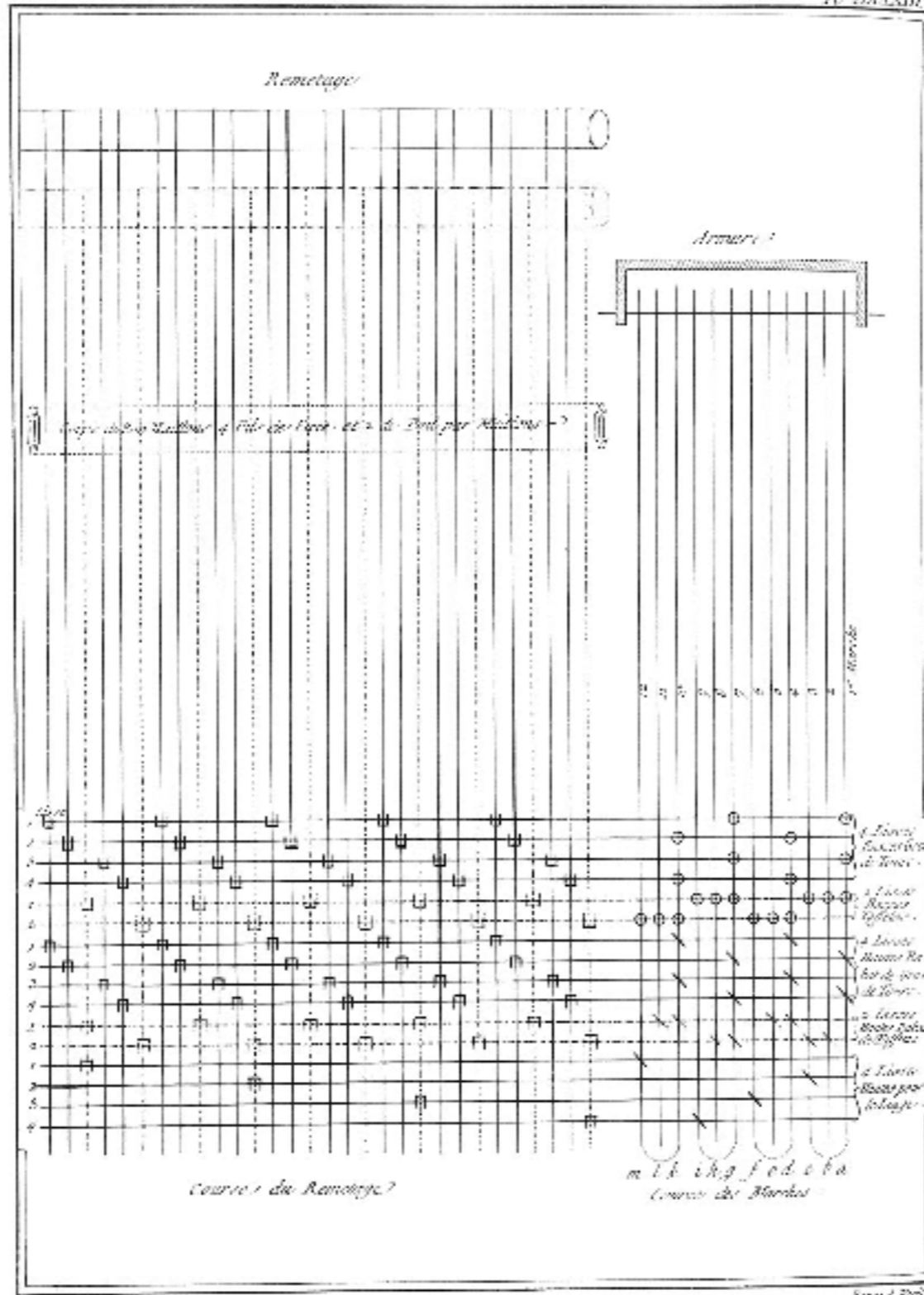

Extrait de...

Plan de...

*Soierie, Ras de Soierie livré de 40 Portées Double chaîne pour la Piece, 20 Portées simples pour le 1<sup>er</sup> Poil, le Liège est pris sur le Poil.* 00

“Soierie, ...”

The Encyclopedia of Diderot & d'Alembert 1763  
 (University of Michigan)

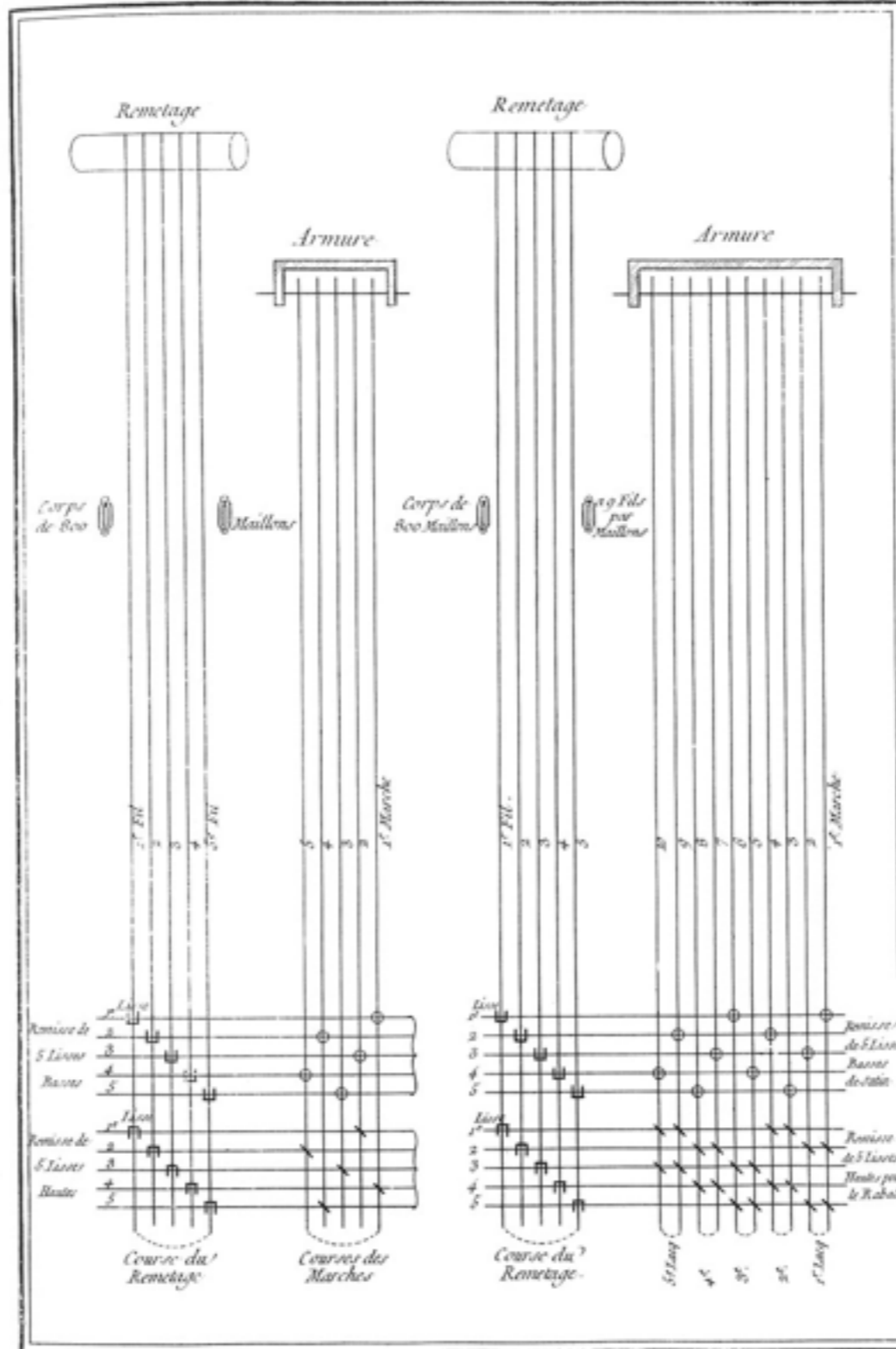

Benard Del.

Benard Fecit.

*Soierie, Damas courant toute la chaîne est passée dans le Corps et Damas Gros Grain de Lustrine.*

pp

“Soierie, ...”

The Encyclopedia of Diderot & d'Alembert 1763  
(University of Michigan)

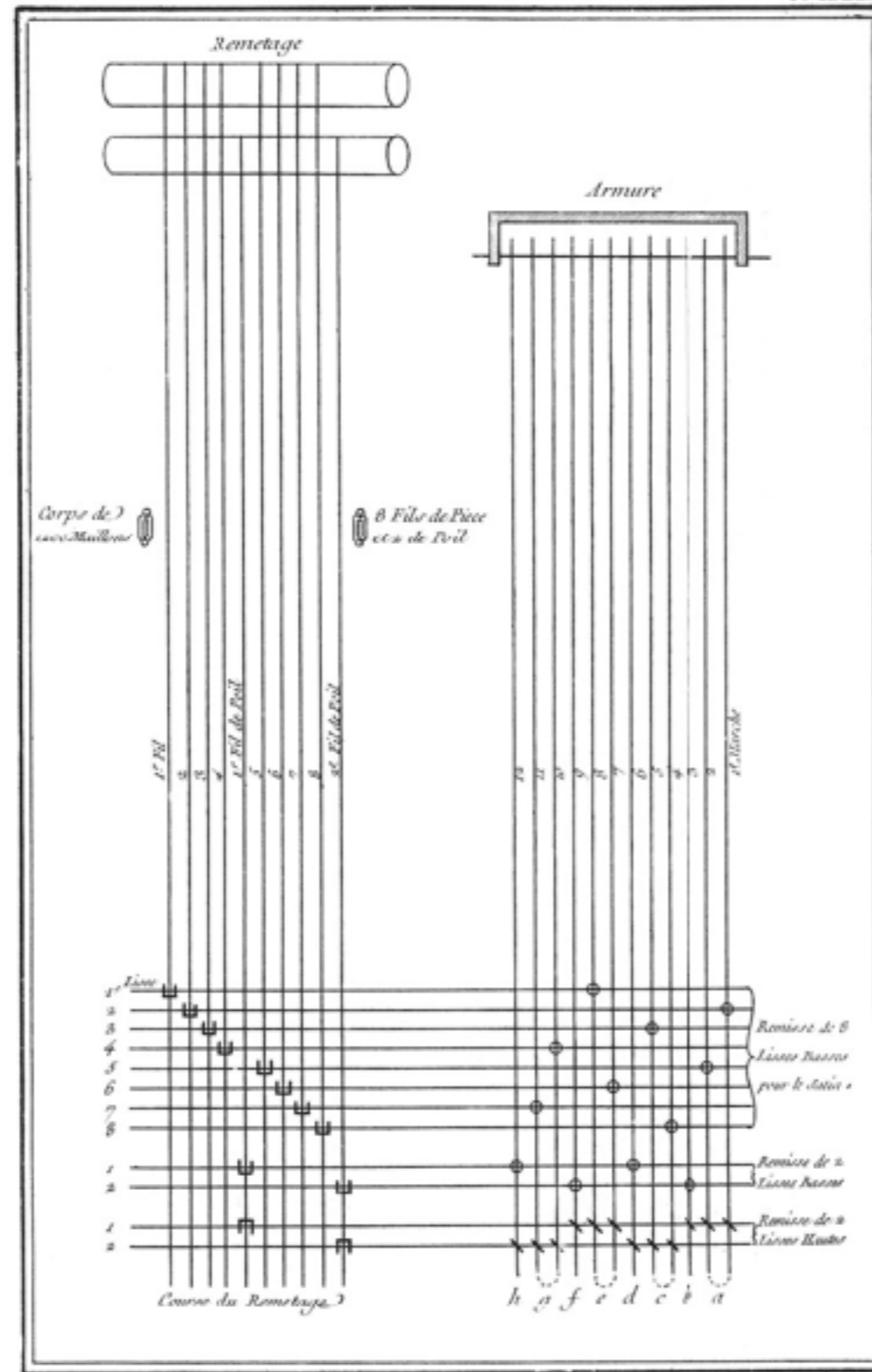

Levasseur Del.

Benard Sculp.

Soierie,  
 Damas Lizéré pour Meubles, Largeur  $\frac{5}{8}$  d'Aune.

“Soierie, ...”

The Encyclopedia of Diderot & d'Alembert 1763  
 (University of Michigan)

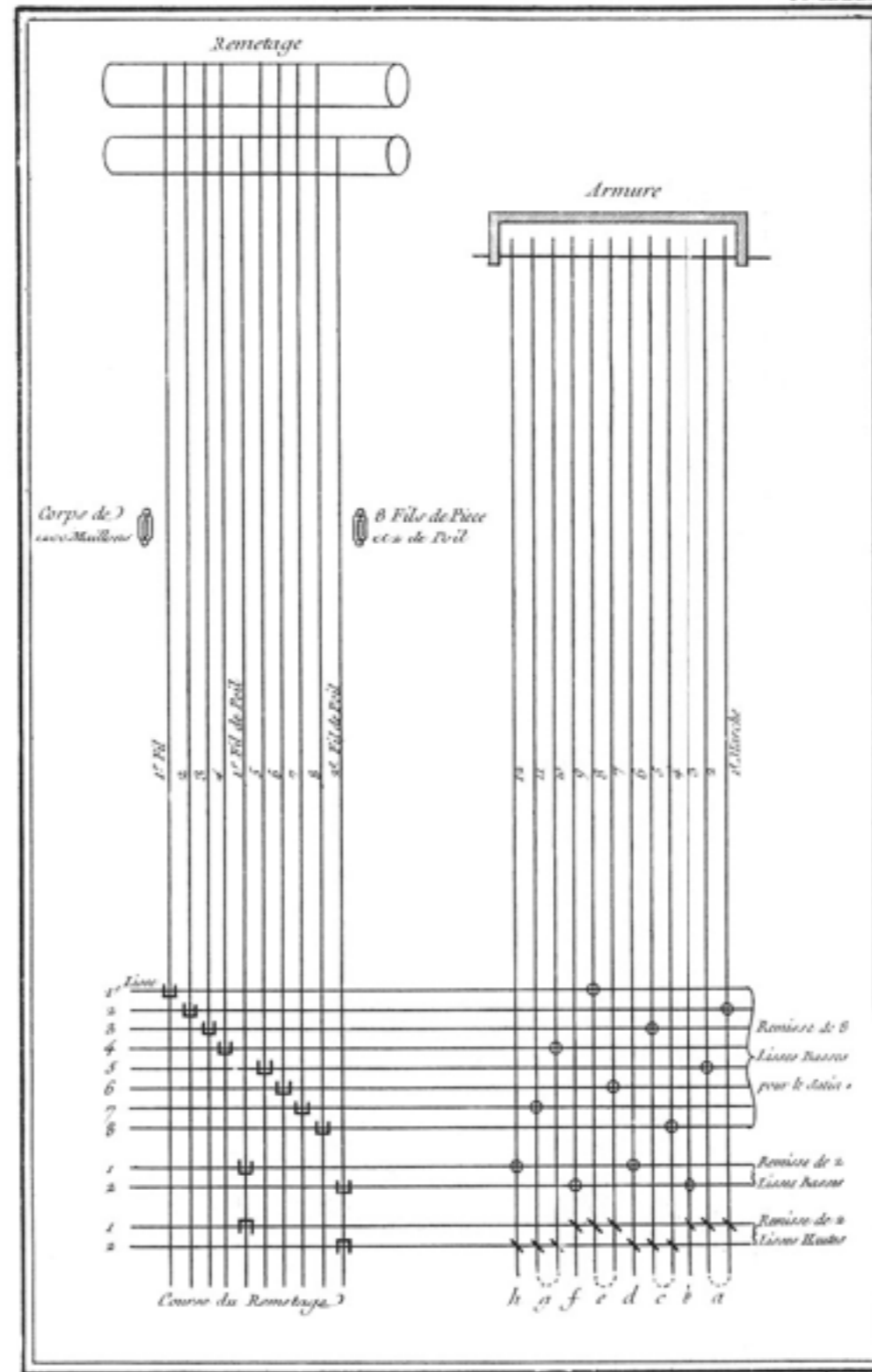

Levasseur Del.

Benard Sculp.

Soierie,  
 Damas Lizéré pour Meubles, Largeur  $\frac{5}{8}$  d'Aune.

“Soierie, ...”

The Encyclopedia of Diderot & d'Alembert 1763  
 (University of Michigan)

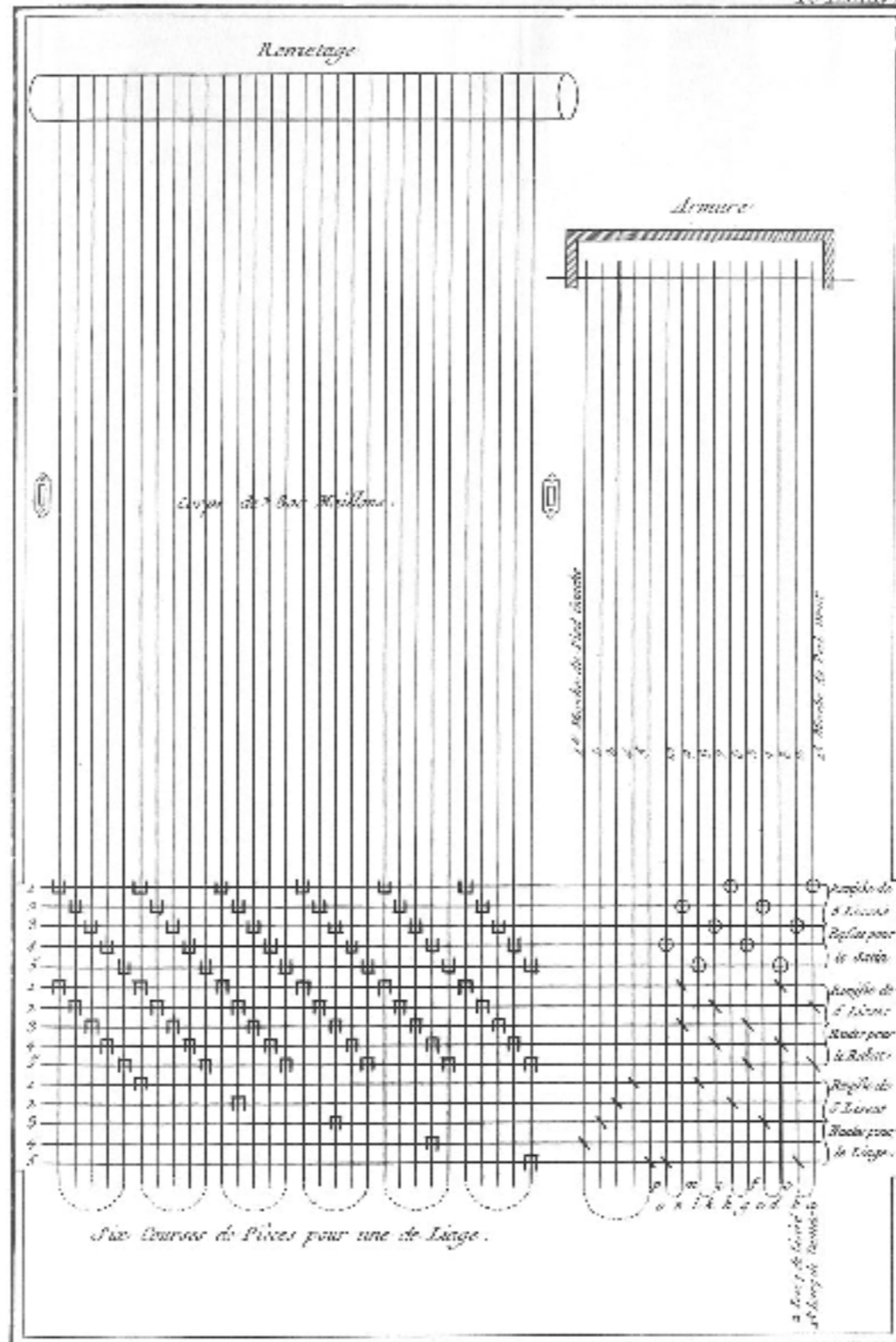

Bois de 1/2

Bois de 1/2

### Soierie,

177

Damas Broché Gros Grain et Tissé avec un Liage de 5 le. 6.

“Soierie, ...”

The Encyclopedia of Diderot & d'Alembert 1763  
(University of Michigan)

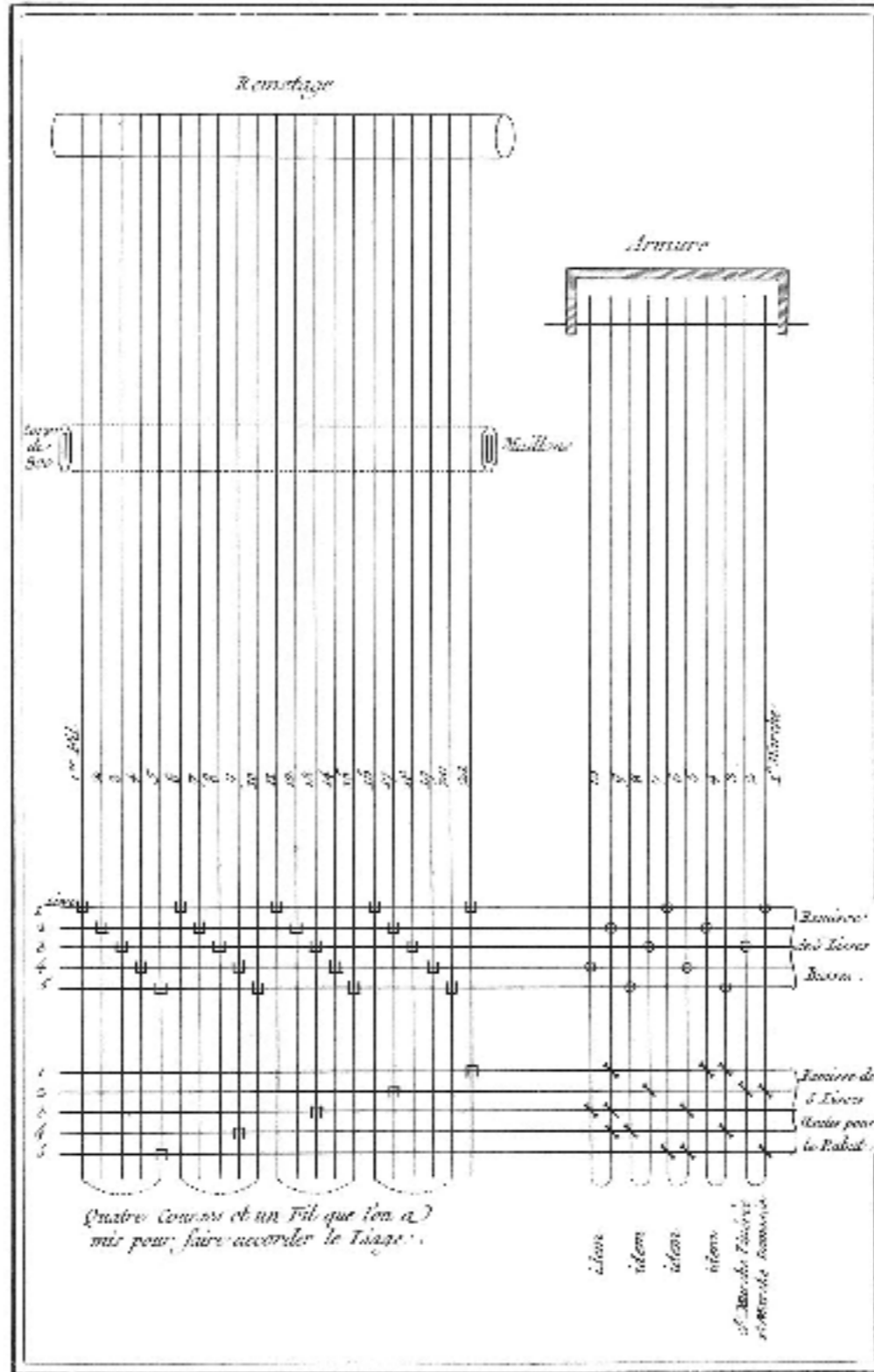

Quatre Couloirs et un Fil que l'on a mis pour faire accorder le Tissage.

Soierie,  
Florentine Damassée avec un Lizere

"Soierie, ..."

The Encyclopedia of Diderot & d'Alembert 1763  
(University of Michigan)

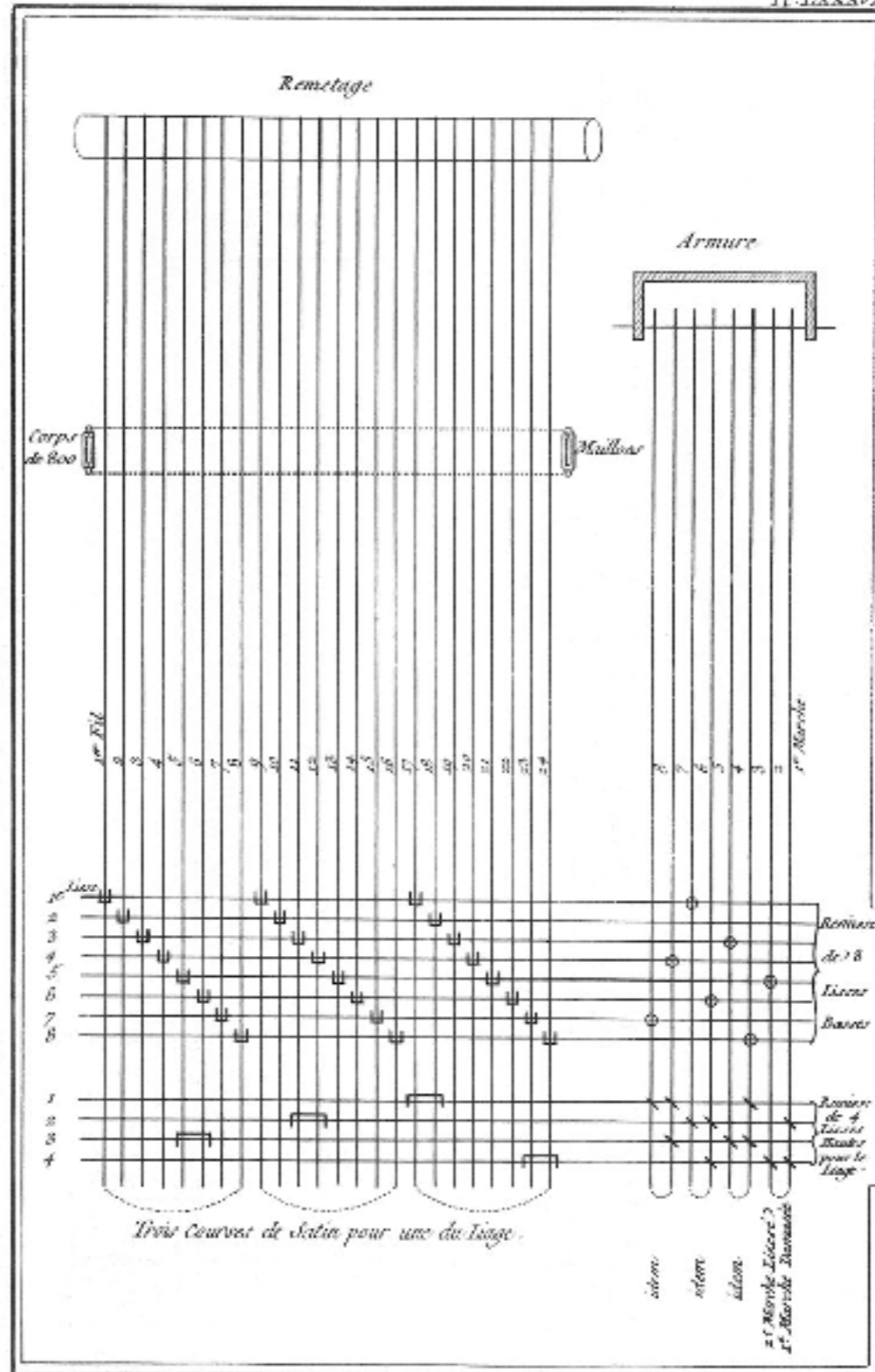

*Soierie,*  
*Florentine Damassée avec un Lixier et un Linge.*

tt

“Soierie, ...”

The Encyclopedia of Diderot & d'Alembert 1763  
 (University of Michigan)

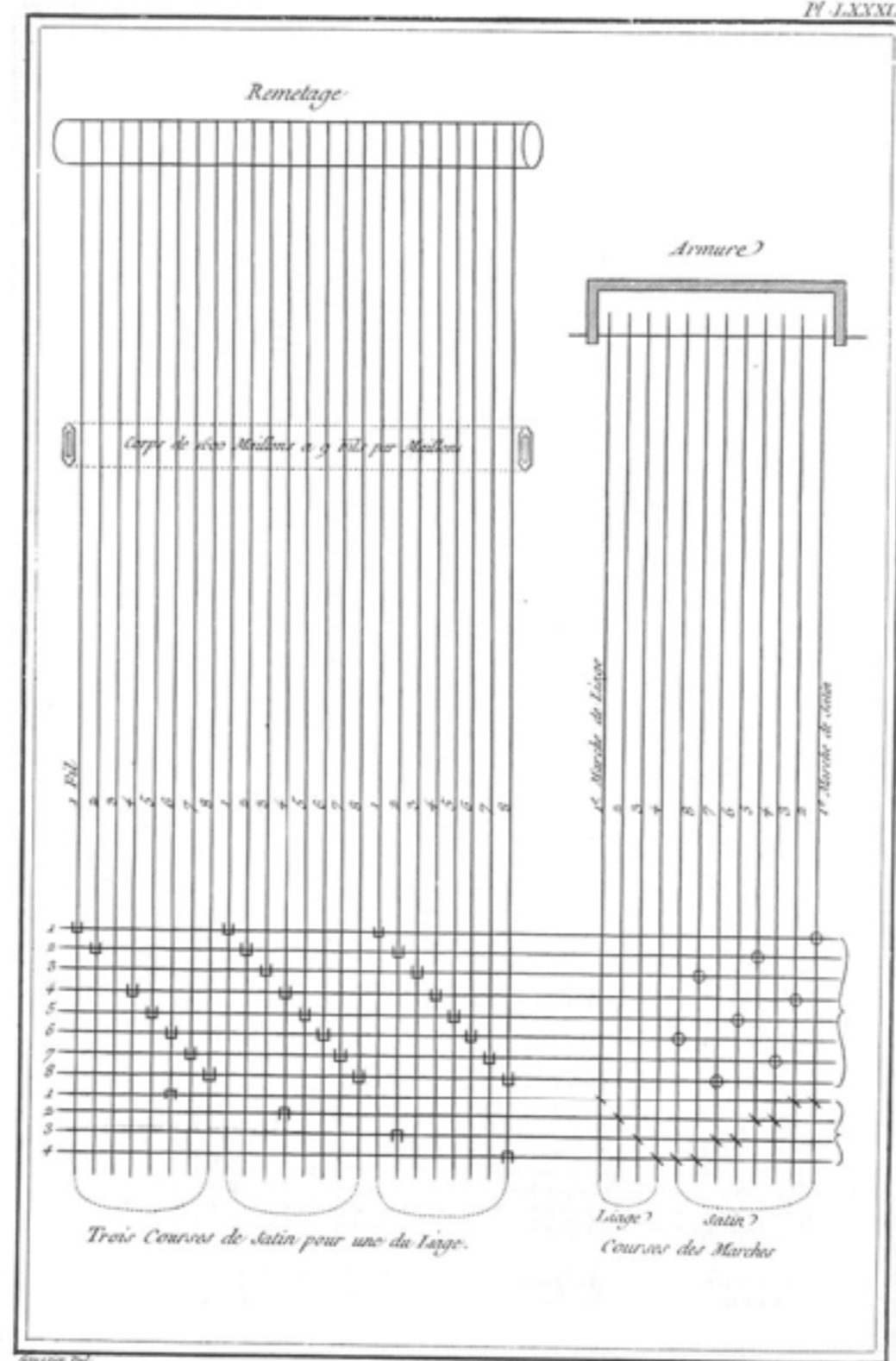

Wassier del.

Benard fecit.

### Soierie,

uuu

Satin. 1. 2. 3. 4 Lince, Courants ou Brochés avec un Lince de 5 le 6.

“Soierie, ...”

The Encyclopedia of Diderot & d'Alembert 1763  
(University of Michigan)

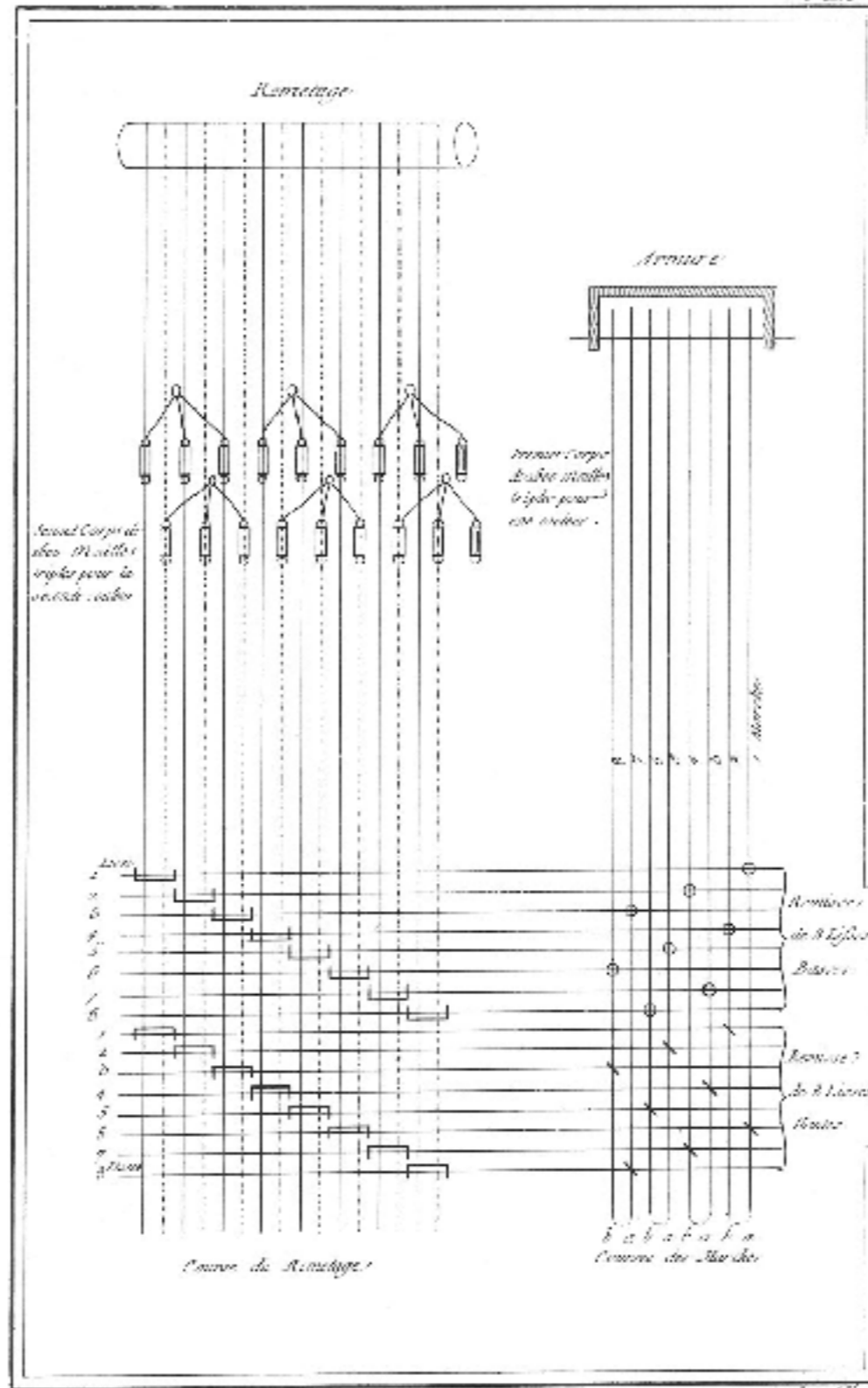

Soierie,  
satin à fleurs à deux faces.

“Soierie, ...”  
The Encyclopedia of Diderot & d'Alembert 1763  
(University of Michigan)

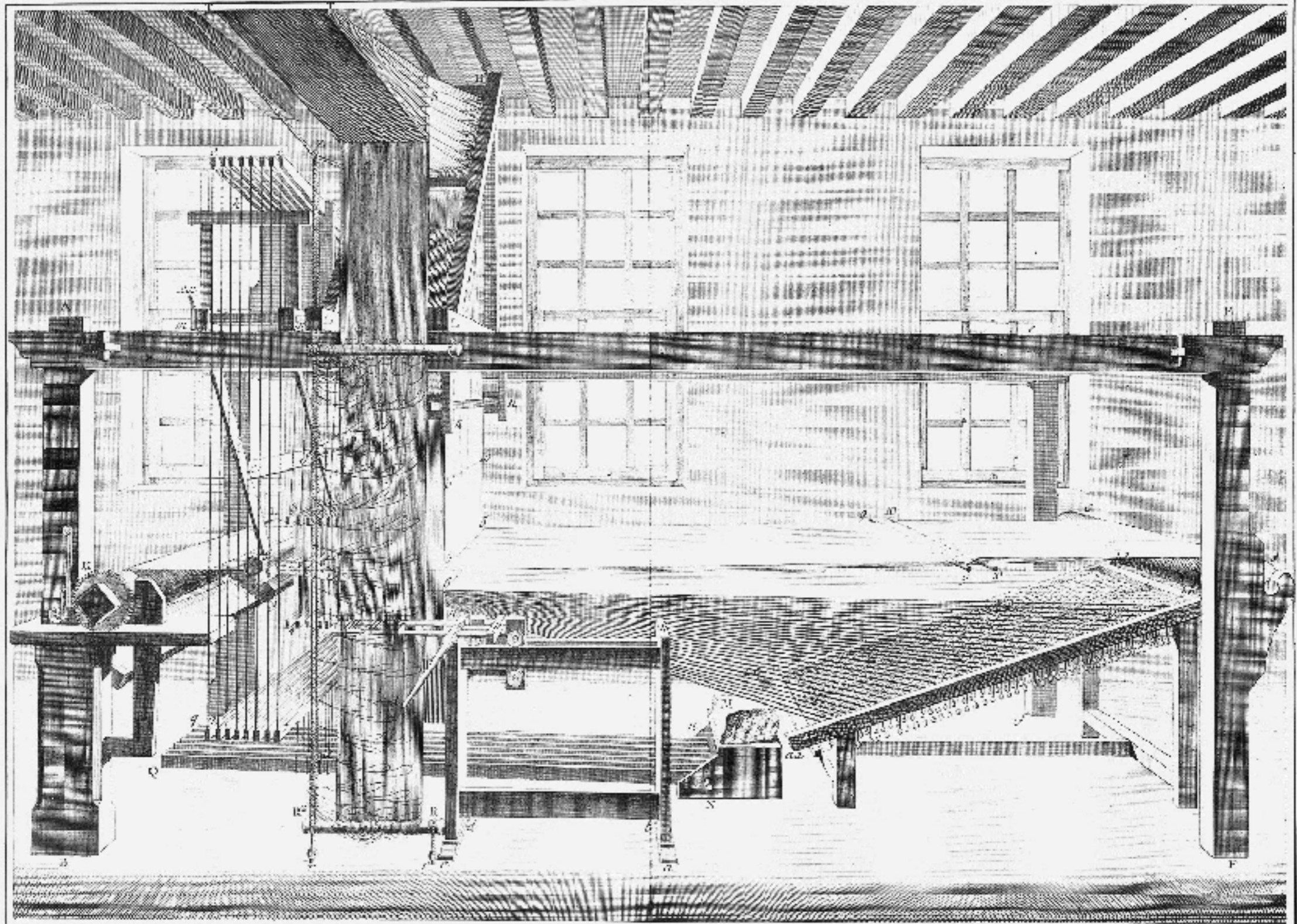

*Soierie, Velours. Elevation Perspective du Métier pour fabriquer le Velours ciselé, ou dans l'instant de la Tère et du D'abbate des Fers*

“Soierie, ...”

The Encyclopedia of Diderot & d'Alembert 1763  
(University of Michigan)

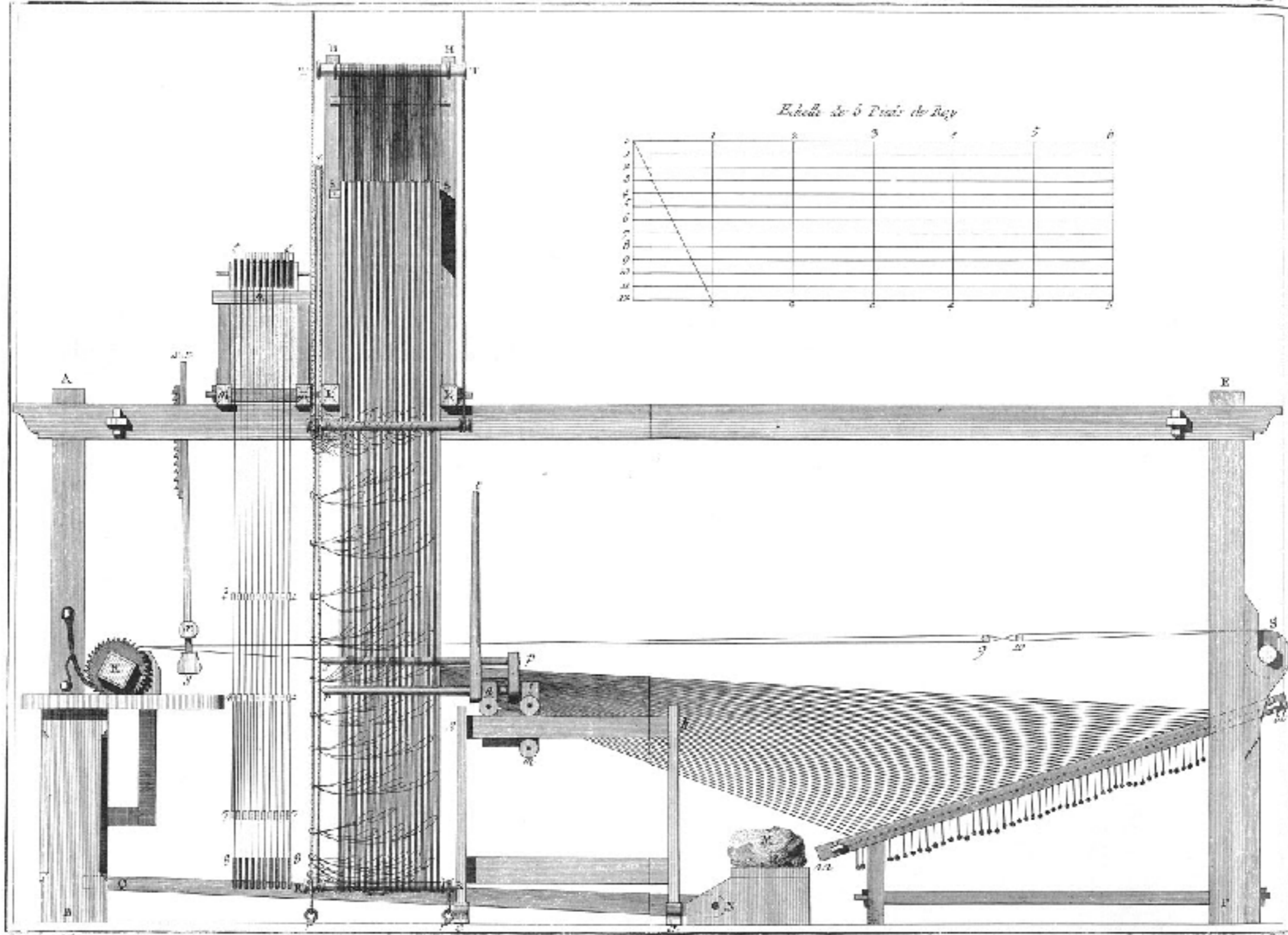

*Soierie, Velours. Elevation Latérale du Mûrier pour fabriquer le Velours Ciselé. Vu dans l'instant qui précède celui de la Ture.*

“Soierie, ...”

The Encyclopedia of Diderot & d'Alembert 1763  
(University of Michigan)

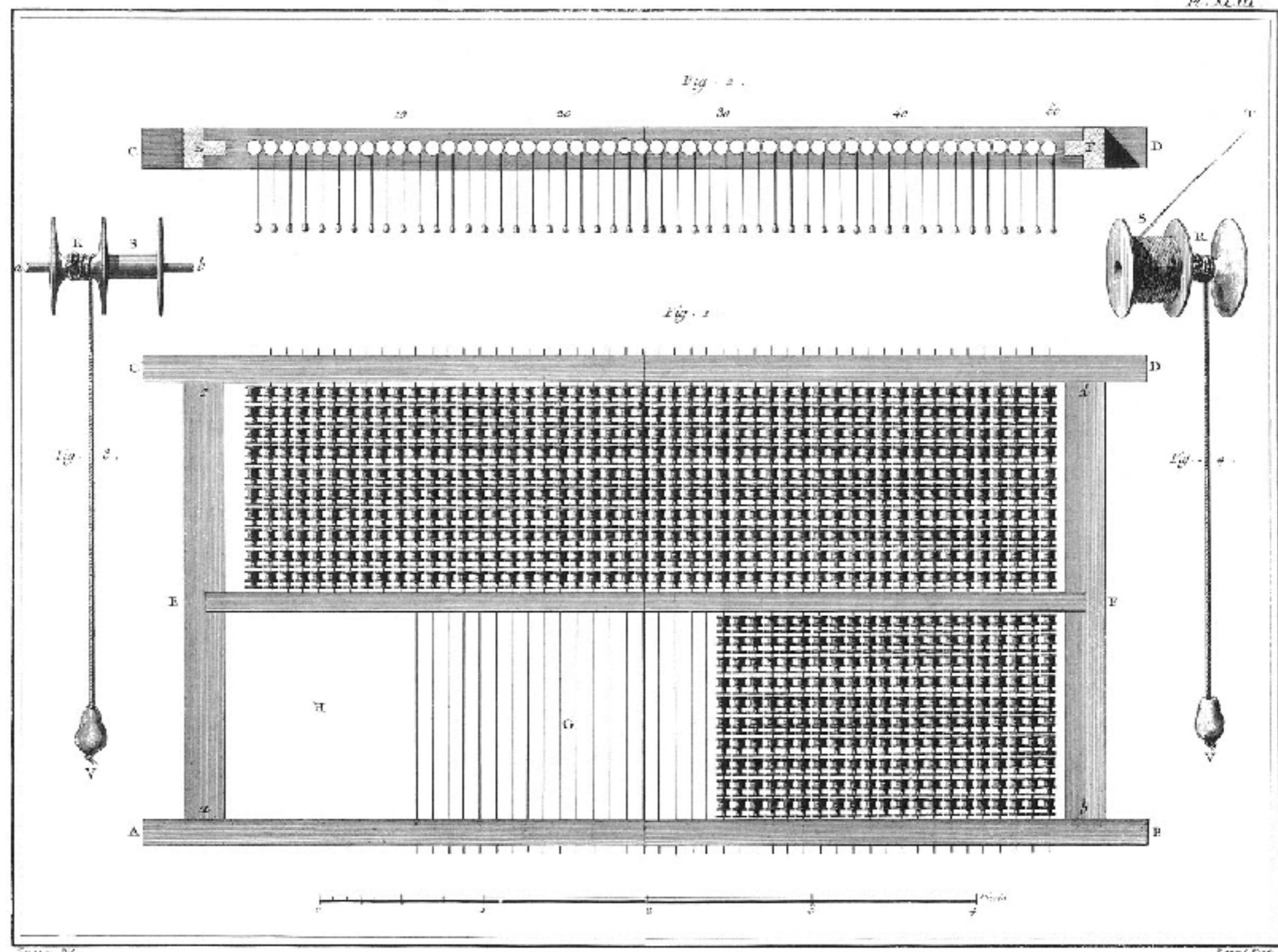

*Soierie, Velours Ciselé. Plan de la Cantre et Développement des Bouquets.*

a.a.a

“Soierie, ...”  
 The Encyclopedia of Diderot & d'Alembert 1763  
 (University of Michigan)

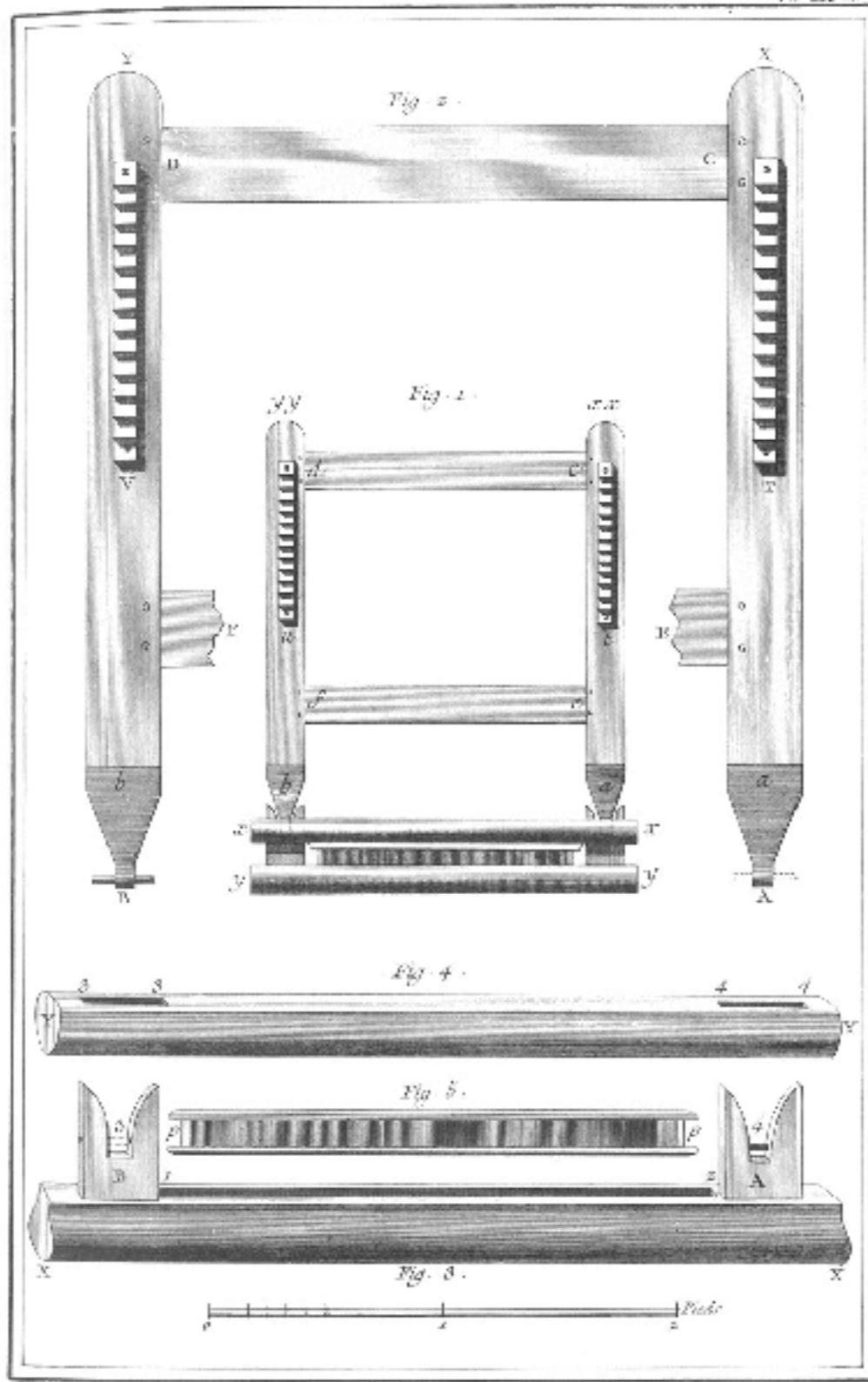

*Soierie. Velours, Développement du Battant brisé du Métier à Velours.* bbb

“Soierie, ...”

The Encyclopedia of Diderot & d'Alembert 1763  
(University of Michigan)



*Soierie, Vélours. Construction de l'Entourage.* CCC

“Soierie, ...”

The Encyclopedia of Diderot & d'Alembert 1763  
(University of Michigan)

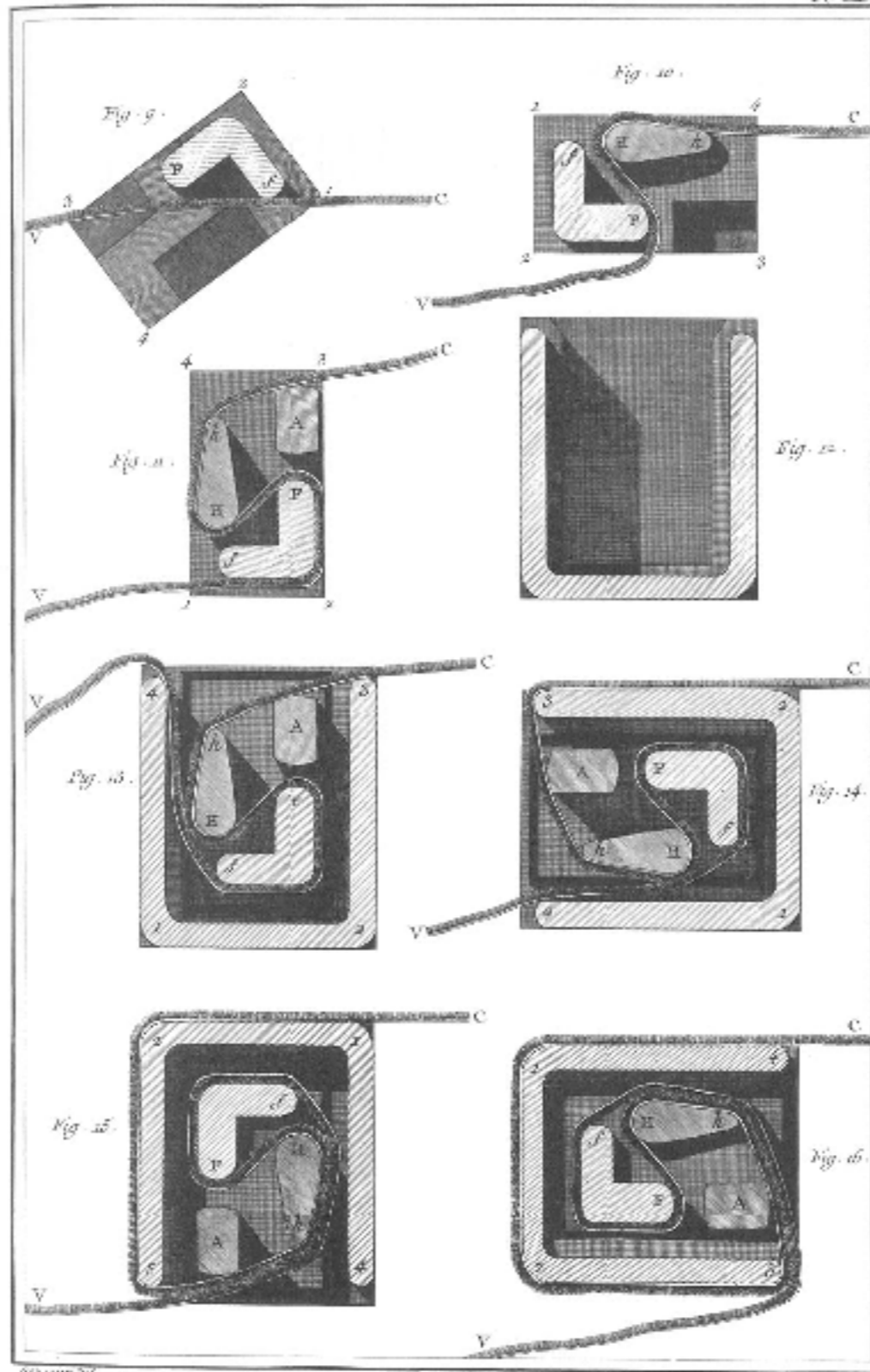

Gravé par Del.

Remonté par Del.

*Soierie, Vélours. Maniere d'Entouquer le Vélours.*

ddd

“Soierie, ...”

The Encyclopedia of Diderot & d'Alembert 1763  
(University of Michigan)

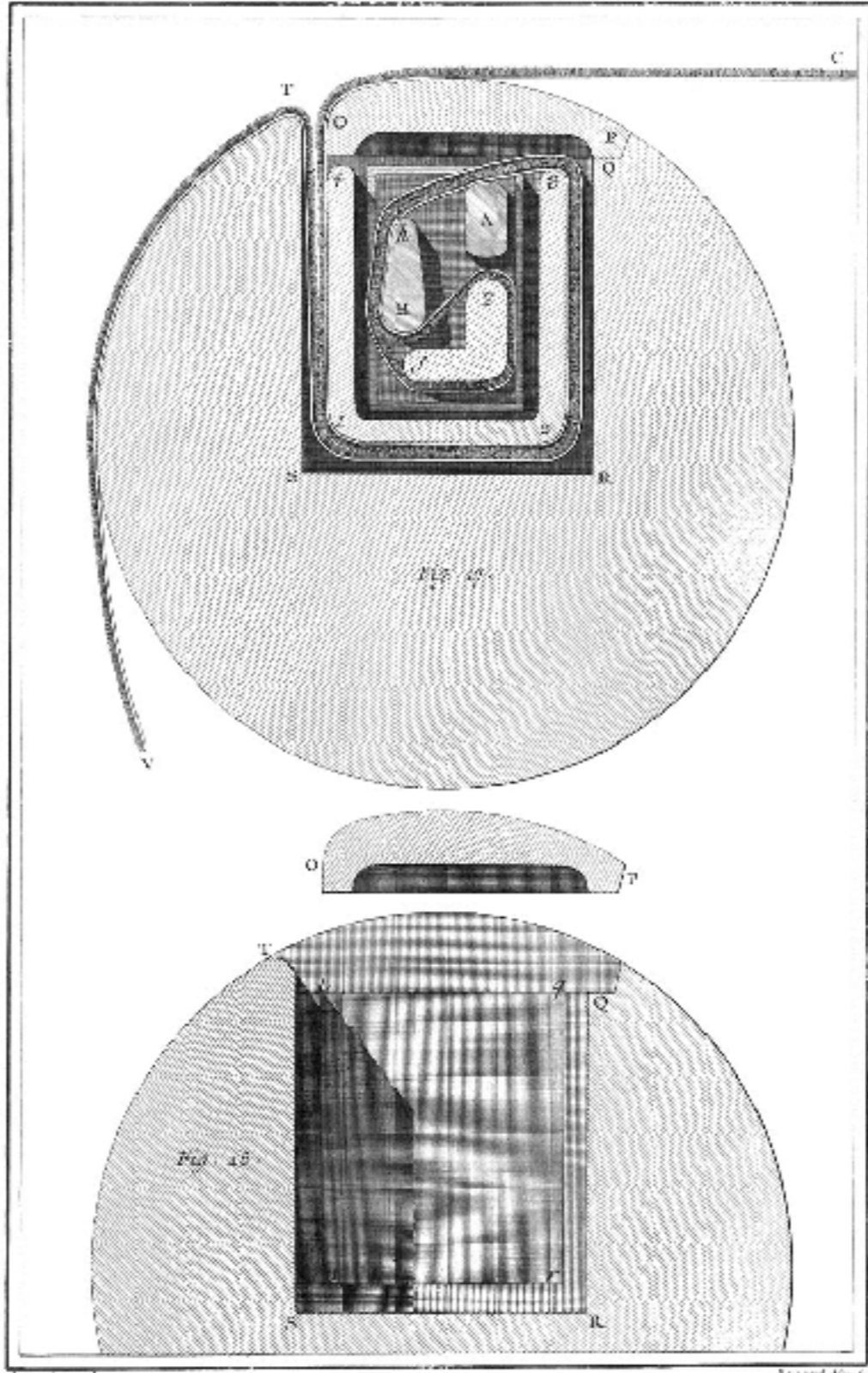

Goussier del. Anard fecit.

Soierie, Velours. suite de la maniere d'ouïr le Têlours. eee

“Soierie, ...”

The Encyclopedia of Diderot & d'Alembert 1763  
(University of Michigan)

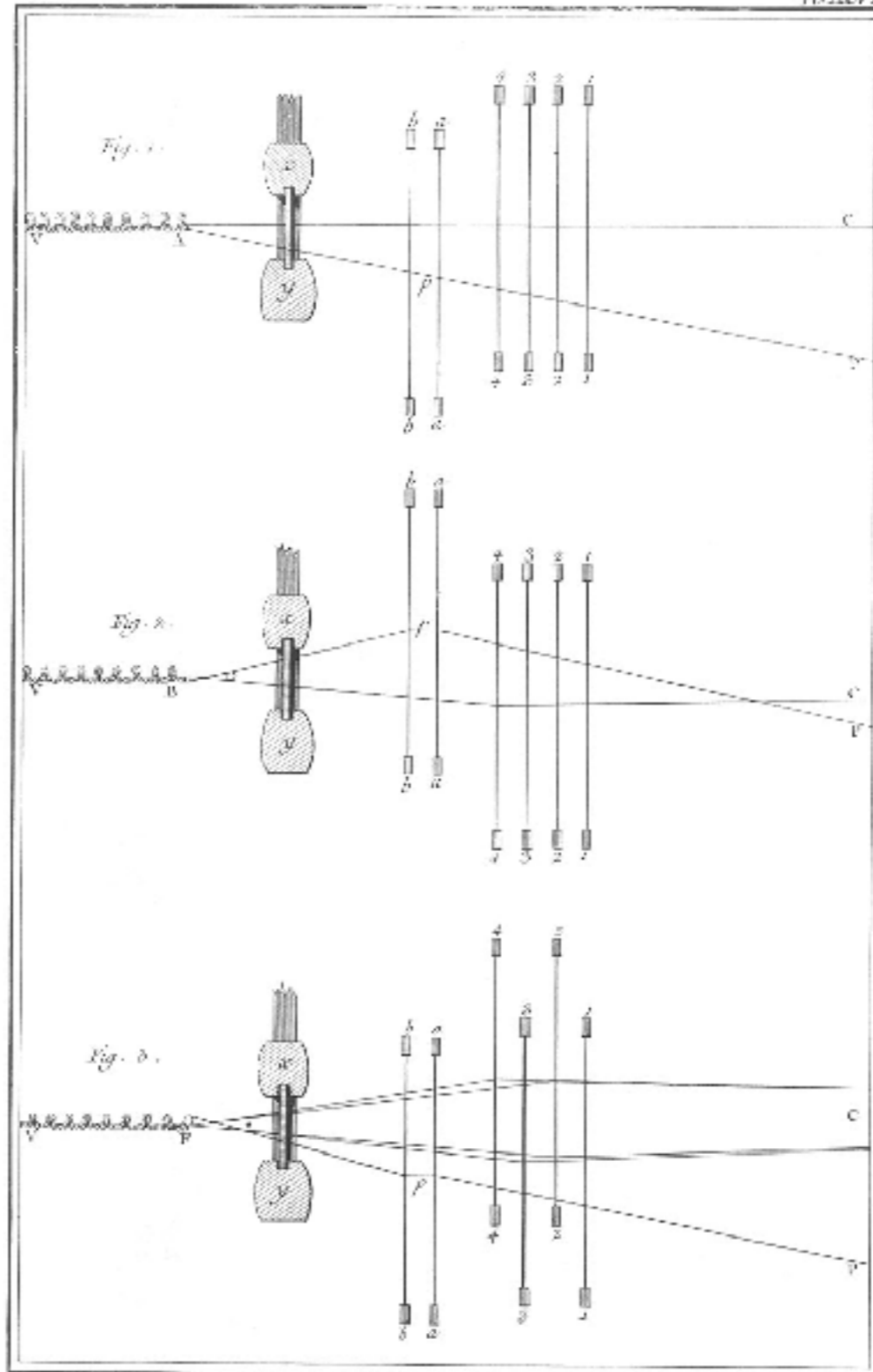

Leveillé del.

Boisard fecit.

*Soierie, Velours Frizé.*

1<sup>o</sup> Les Lièges en repos, 2<sup>o</sup> Passage du Fer, 3<sup>o</sup> premier Coup de Navette.

fff

“Soierie, ...”

The Encyclopedia of Diderot & d'Alembert 1763  
(University of Michigan)

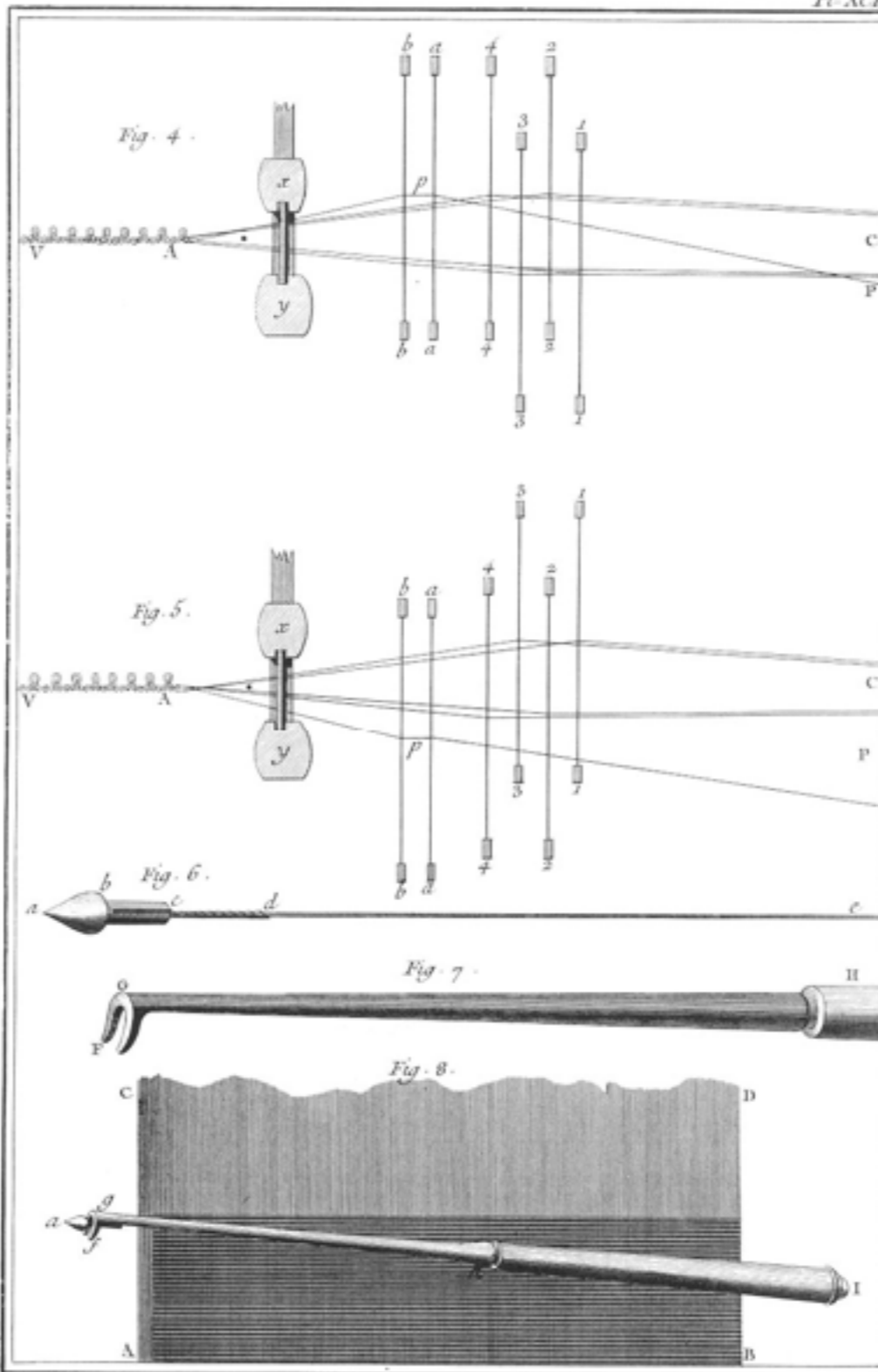

Goussier Del.

Bernard Escit.

*Soierie, Velours Frizé. 4°. second Coup de Navette. 999.  
 5° troisième Coup de Navette, Fers de Frizé garnis de leurs Pedonnes.*

“Soierie, ...”

The Encyclopedia of Diderot & d'Alembert 1763  
 (University of Michigan)

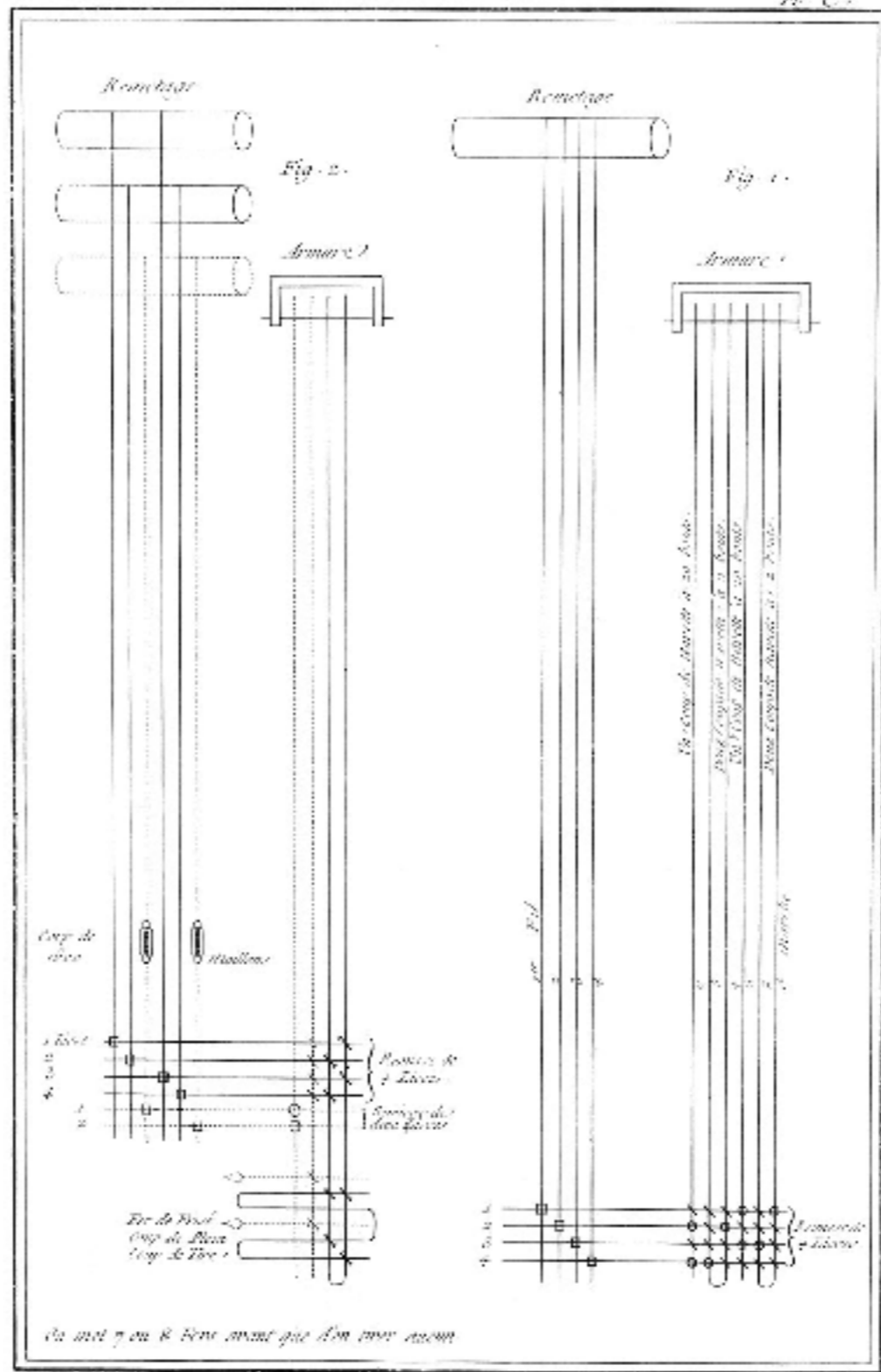

*Soierie,* h.h.h  
*Télours filés sans Contes, et Télours d'Angleterre Raz.*

“Soierie, ...”

The Encyclopedia of Diderot & d'Alembert 1763  
 (University of Michigan)

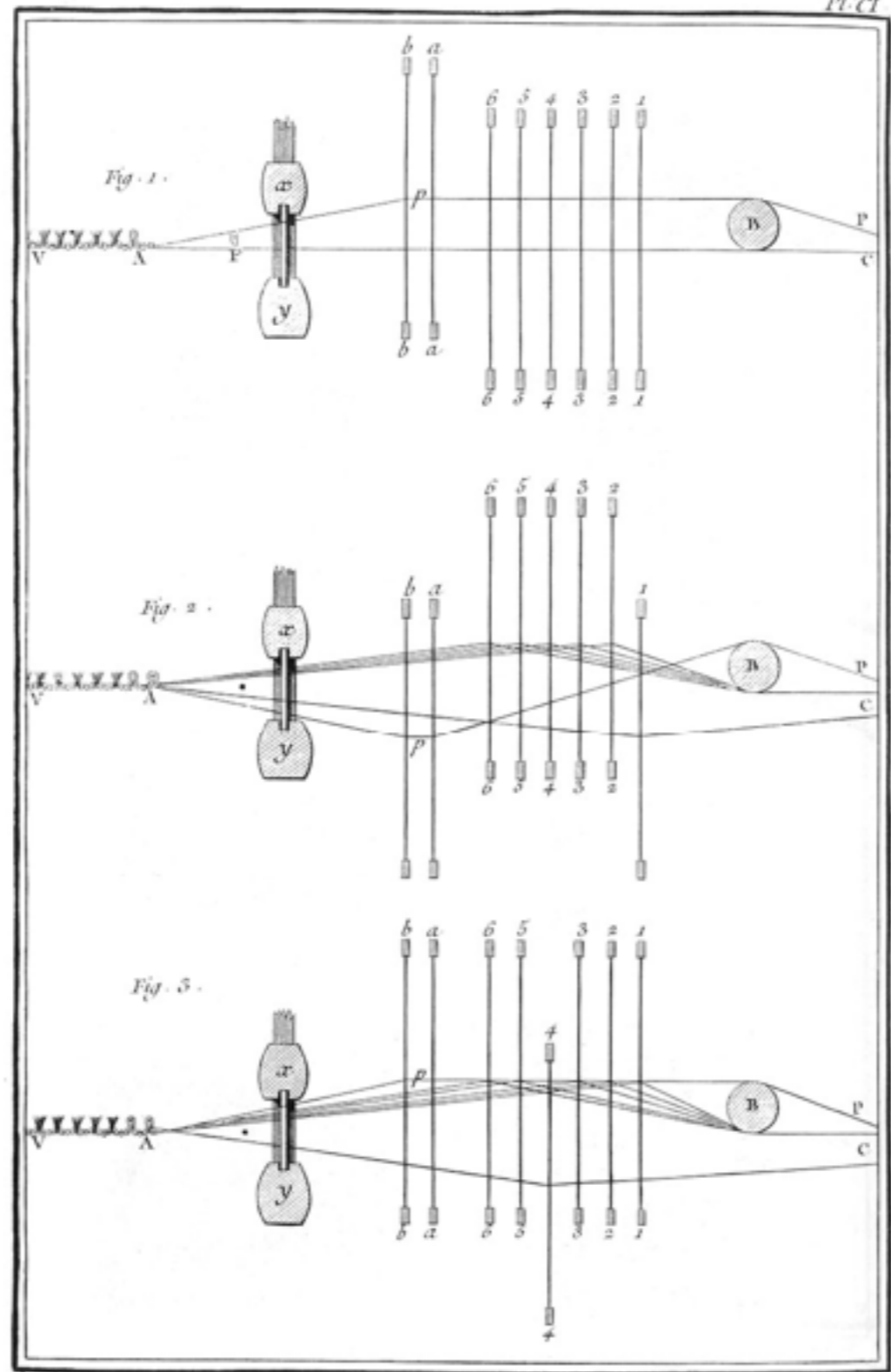

*Soierie, Velours Coupé,* iii  
 1<sup>o</sup> Passage du Fer, 2<sup>o</sup> premier Coup de Navette, 3<sup>o</sup> second Coup de Navette.

“Soierie, ...”

The Encyclopedia of Diderot & d'Alembert 1763  
 (University of Michigan)

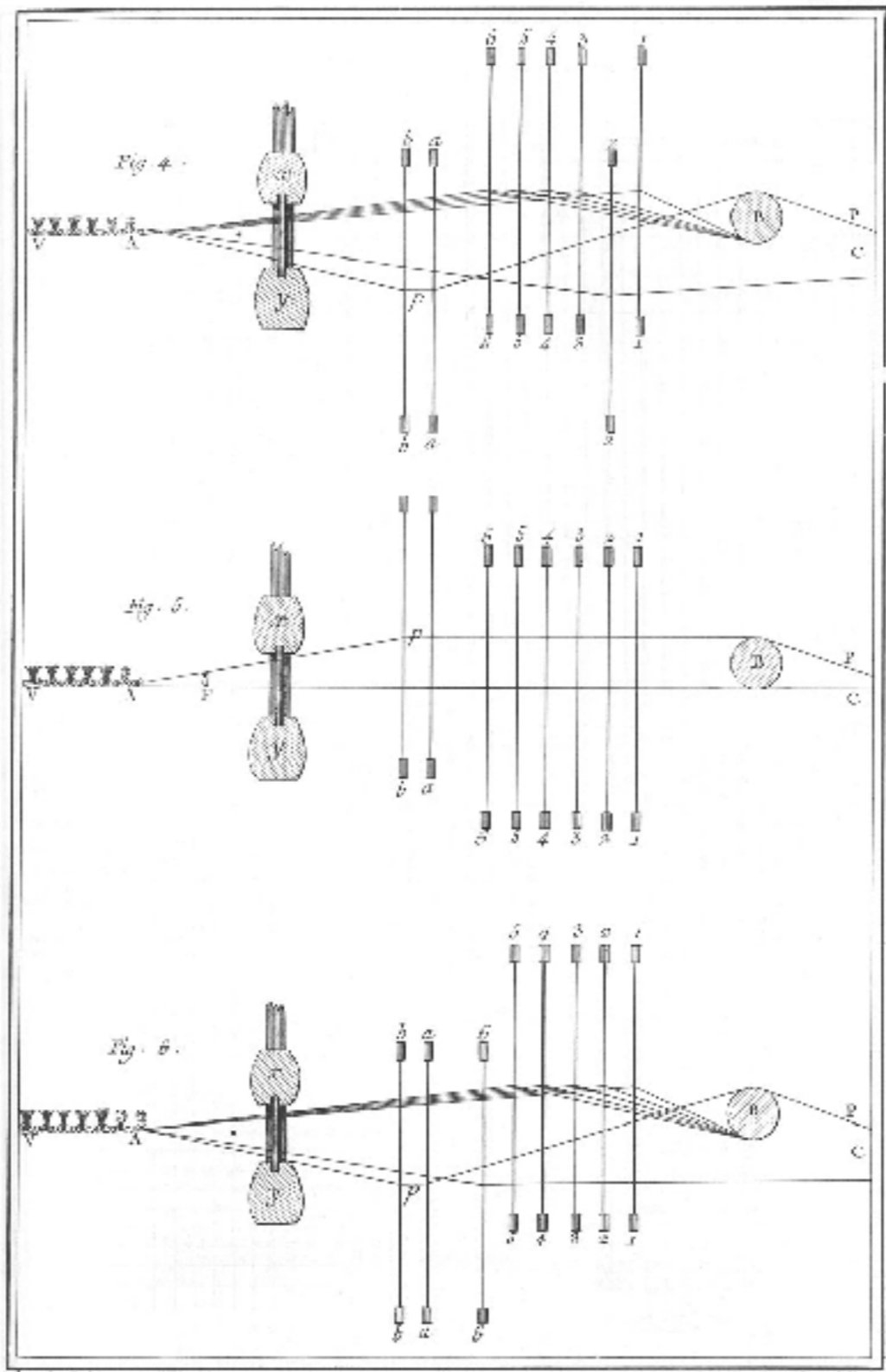

Beauvais Del.

Boisot Sculp.

*Soierie, Velours Coupe.*

k.k.k

4°. troisieme Coup de Navette, 5°. Passage du Fer, 6°. quatrieme Coup de Navette.

“Soierie, ...”

The Encyclopedia of Diderot & d'Alembert 1763  
(University of Michigan)

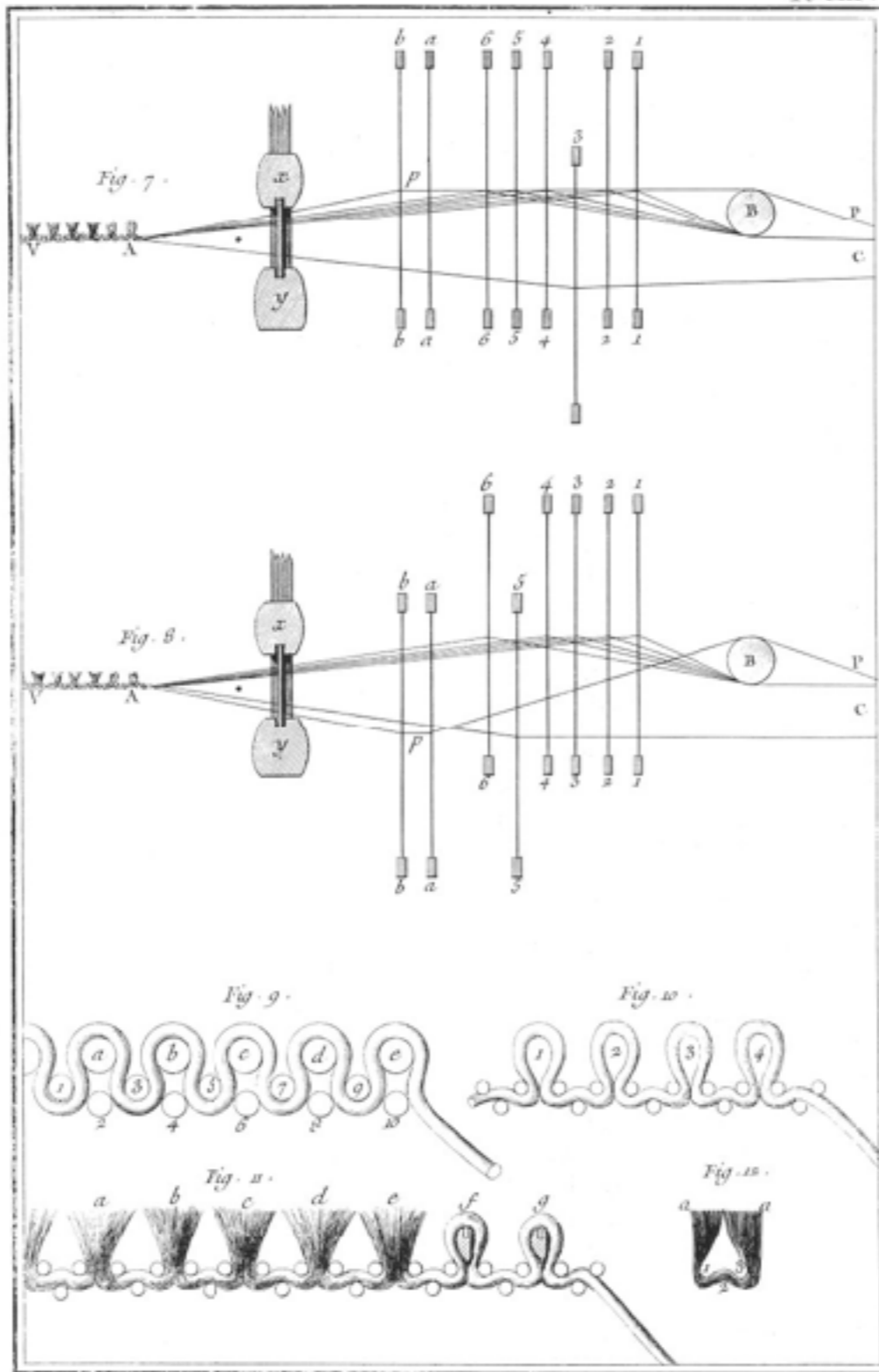

*Soierie, Velours Coupé. 7<sup>e</sup> Cinquieme Coup de Navette. 8<sup>e</sup> Sixieme Coup de Navette. Profils du Velours Frisé et du Velours Coupé Vus au Microscope*

“Soierie, ...”

The Encyclopedia of Diderot & d'Alembert 1763  
(University of Michigan)

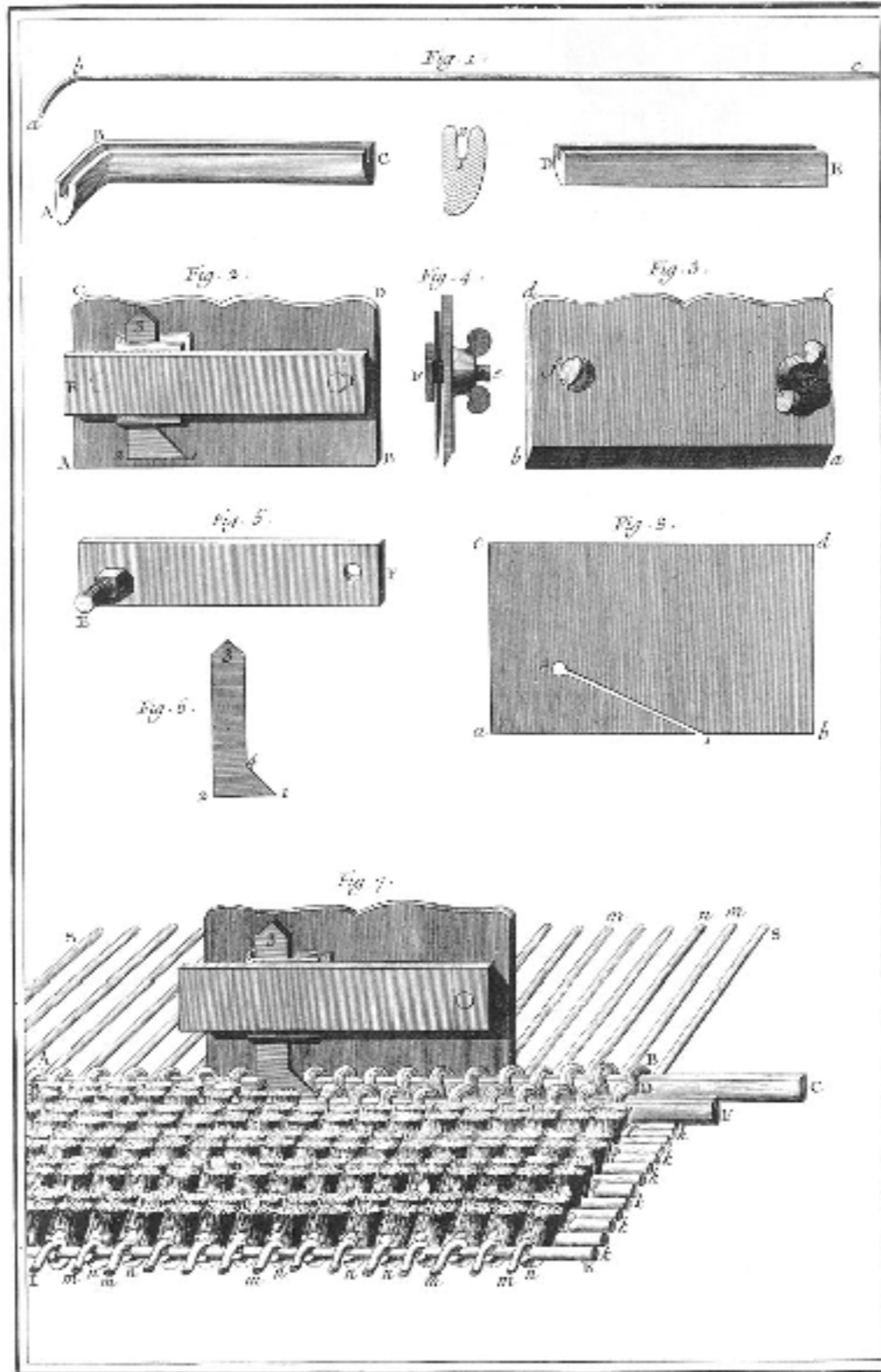

Benard Esc. Enard Esc.

Soierie; Velours Coupé. Fens de Coupé, Rabot, m.m.m  
Vullerolle: Voage du Rabot et Velours Coupé Vu au Microscope et en perspective

“Soierie, ...”

The Encyclopedia of Diderot & d'Alembert 1763  
(University of Michigan)

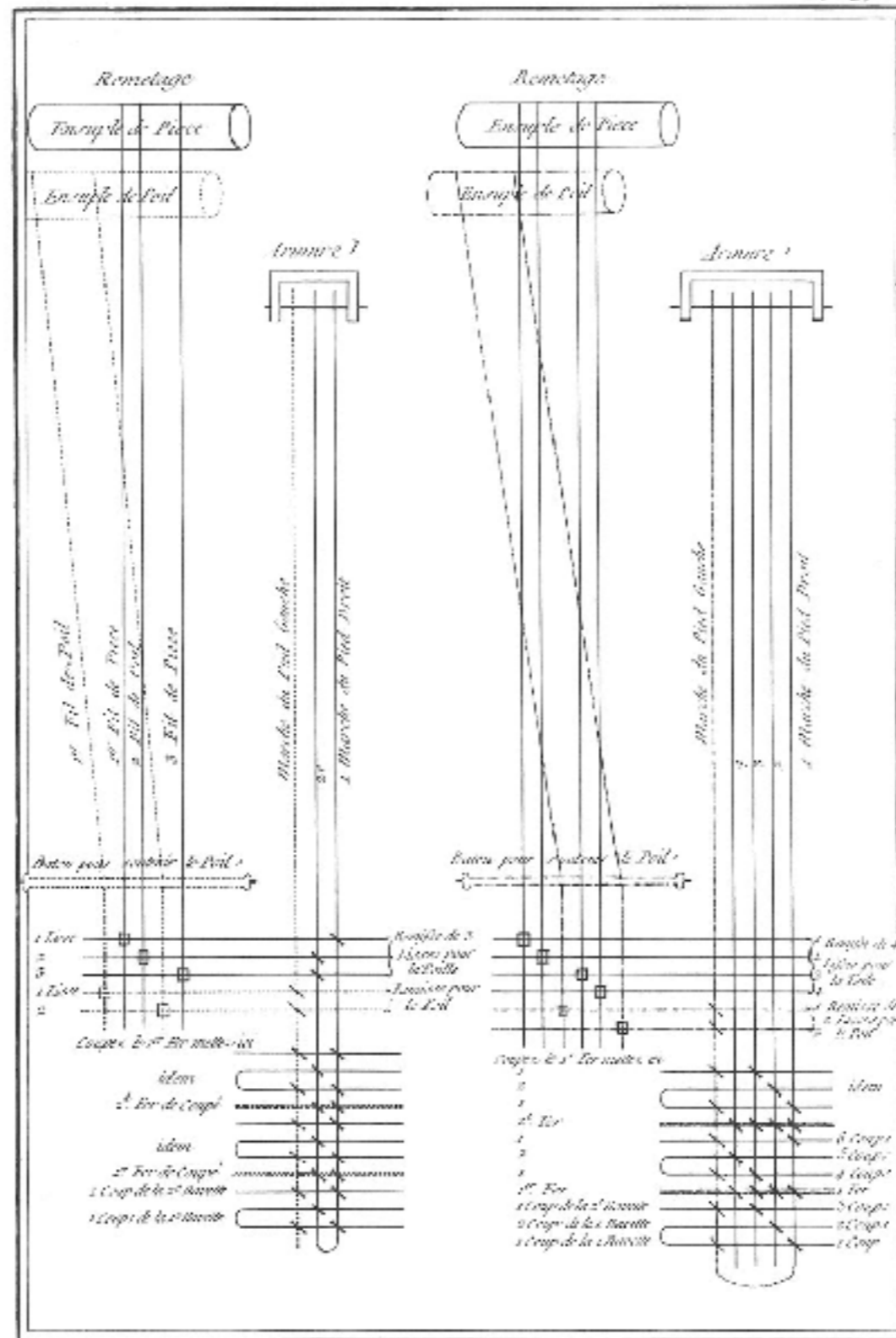

Ensemble de Pièces

Ensemble de Pièces

### Soierie 2,

Filours d'Helikande de 3 Lasses et Filours Uni de 4 Lasses.

N. N. N.

“Soierie, ...”

The Encyclopedia of Diderot & d'Alembert 1763  
(University of Michigan)

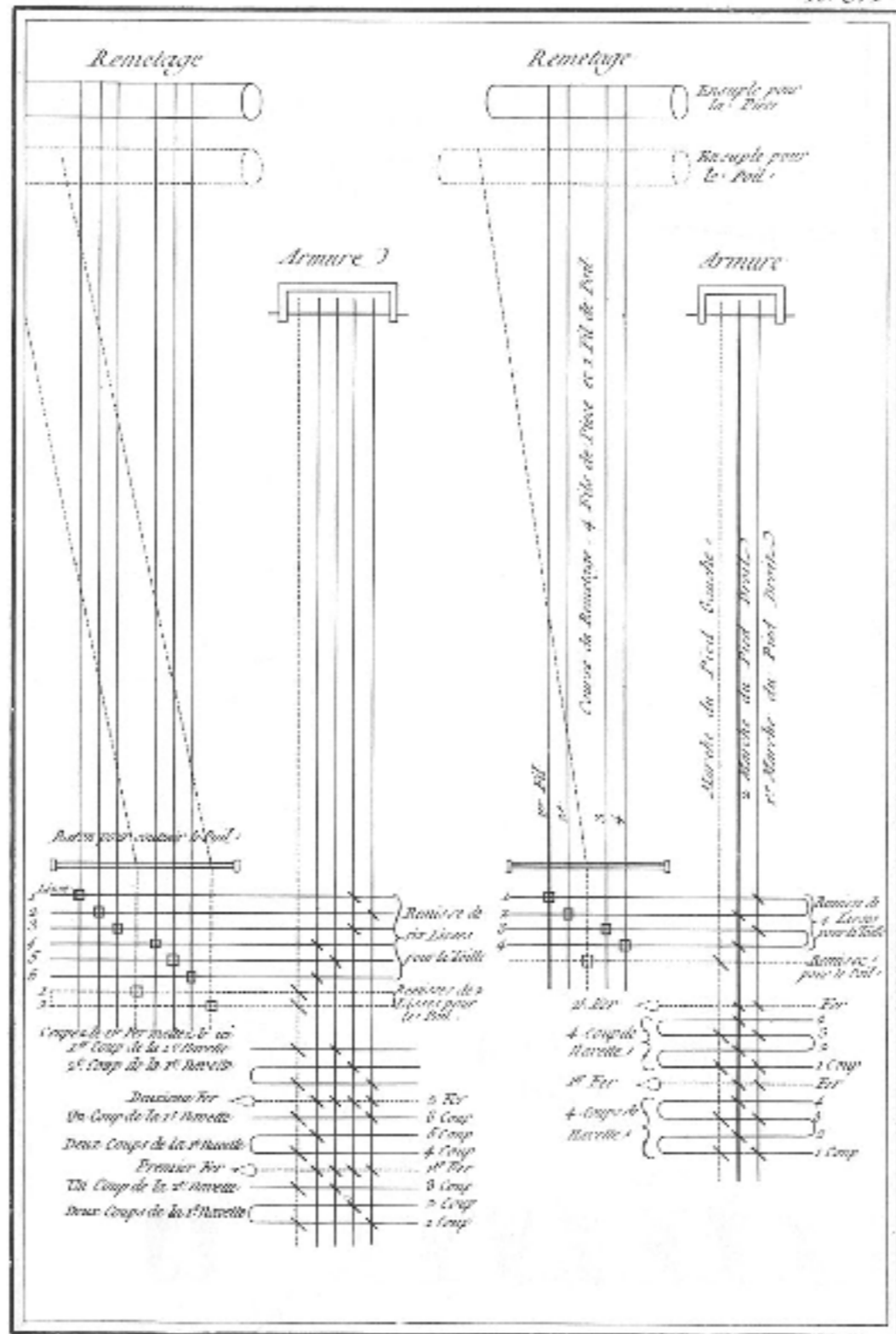

Soierie,  
Velours à 6 Lisses façon de Gênes et Peluche unie . 000

“Soierie, ...”

The Encyclopedia of Diderot & d'Alembert 1763  
(University of Michigan)

*Remontage*

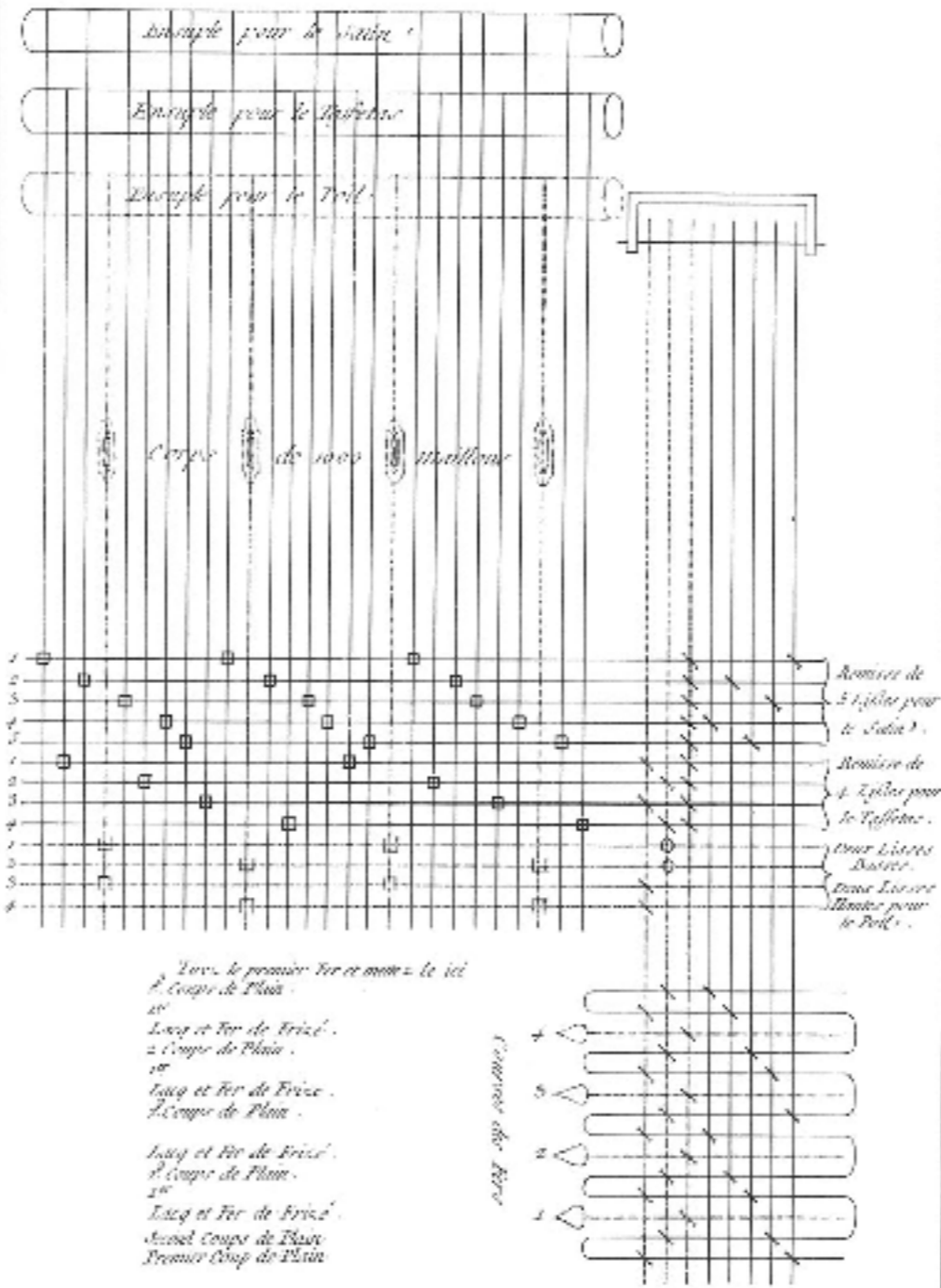

1763-1764

Benard del.

*Soierie,  
Velours frisé, fond Satin sans Centre.*

PPP

“Soierie, ...”

The Encyclopedia of Diderot & d'Alembert 1763  
(University of Michigan)

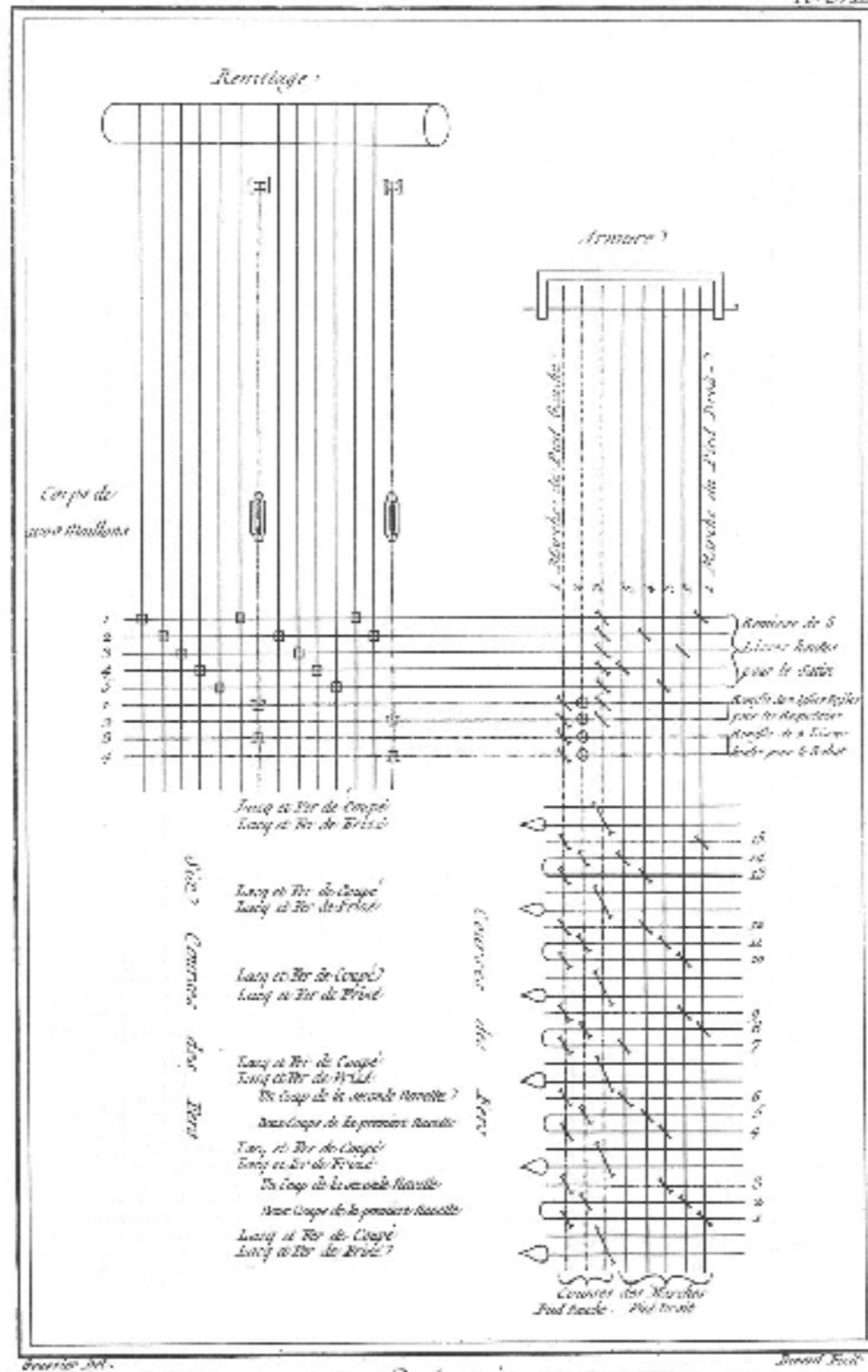

Soierie,  
Velours frisé, Coupé, finet satin 1000 Roquetins 999

“Soierie, ...”

The Encyclopedia of Diderot & d'Alembert 1763  
(University of Michigan)

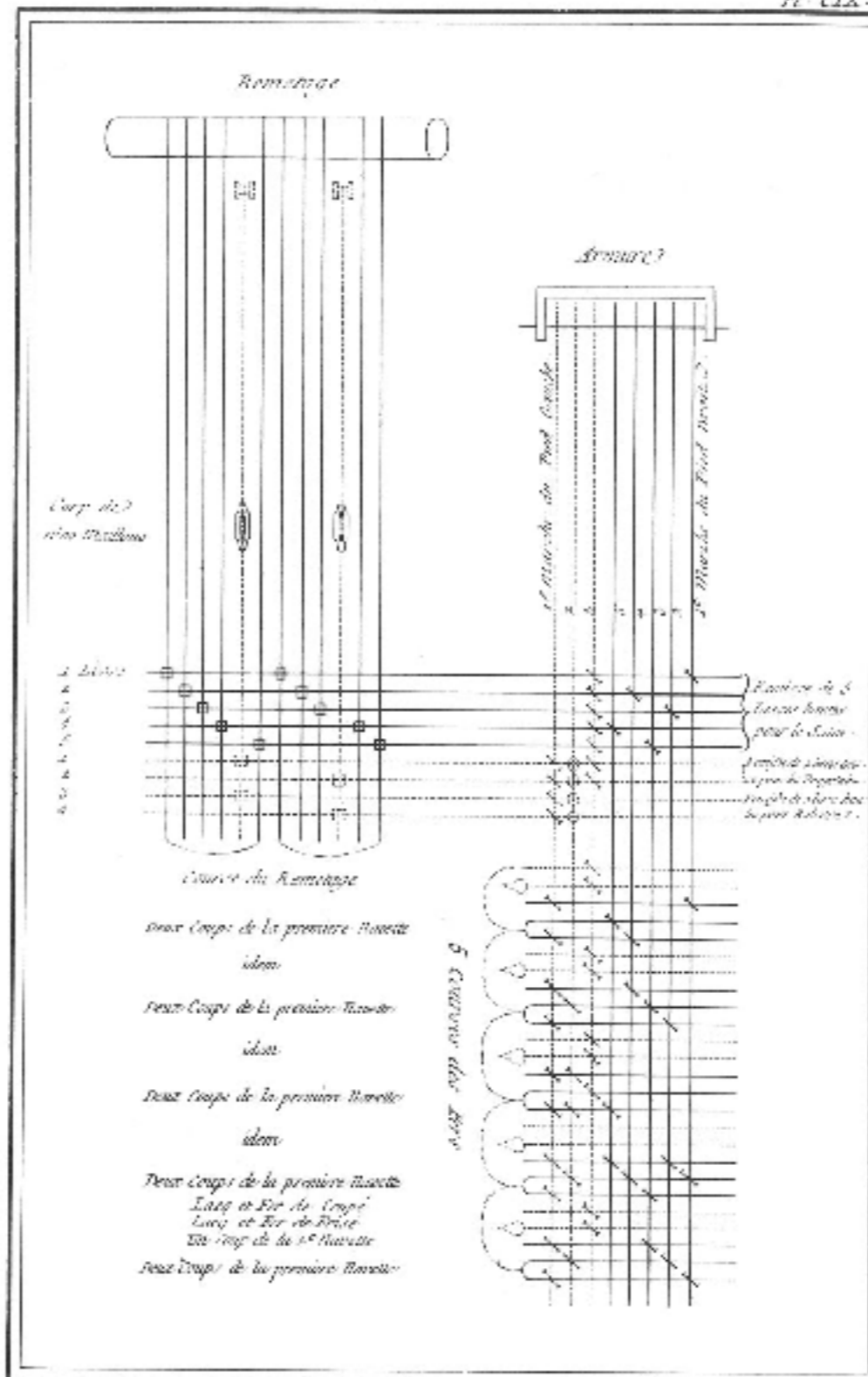

Benard del.

Benard fecit.

*Soierie,*  
*Vélour, frisé, fond Satin, 1600 Roquetains.* r r r

“Soierie, ...”

The Encyclopedia of Diderot & d'Alembert 1763  
(University of Michigan)

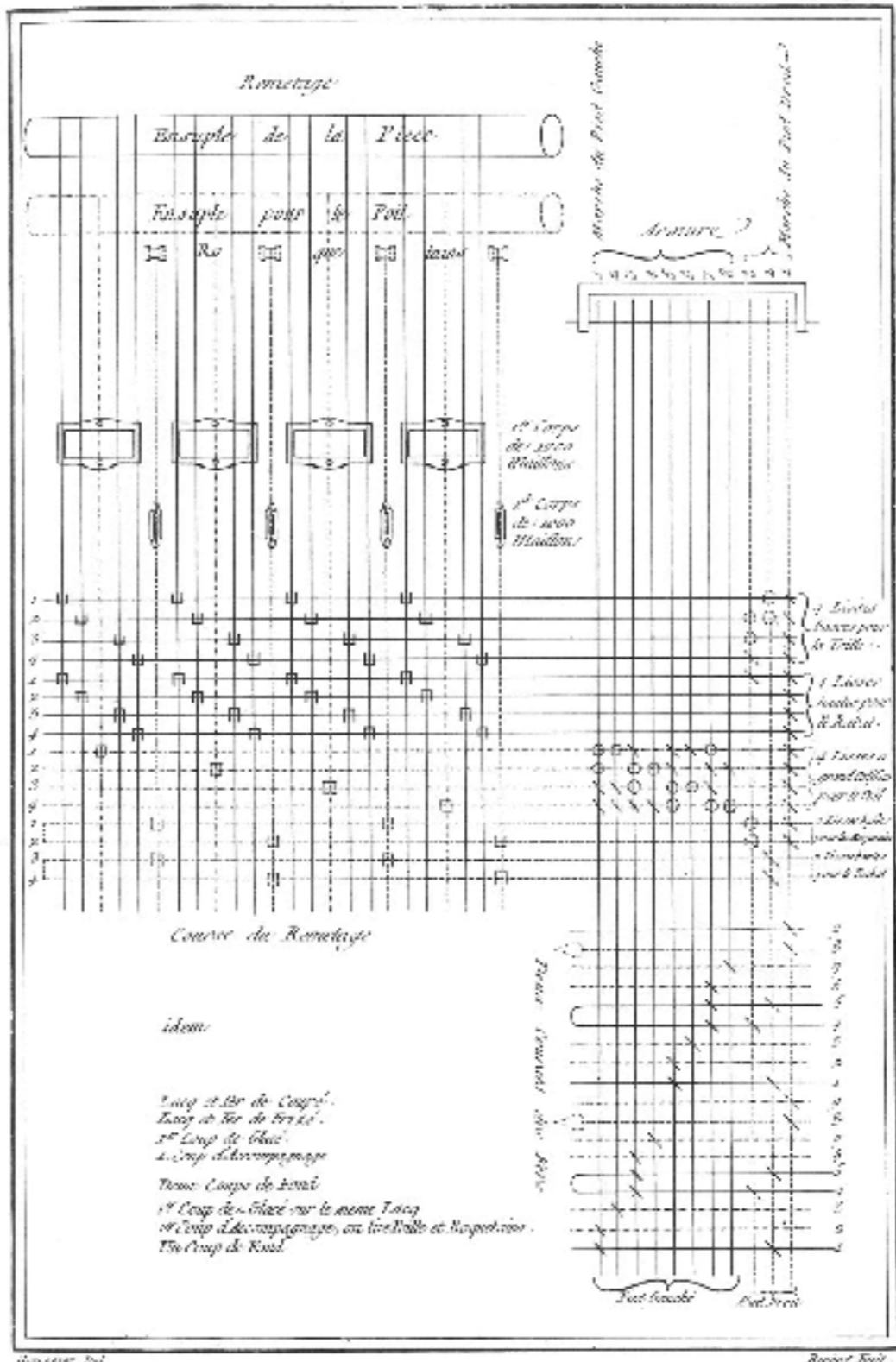

Bourrage fini.

Bourrage fini

*Soierie,*  
*Velours frisé, coupé, Fond Or*

585

“Soierie, ...”

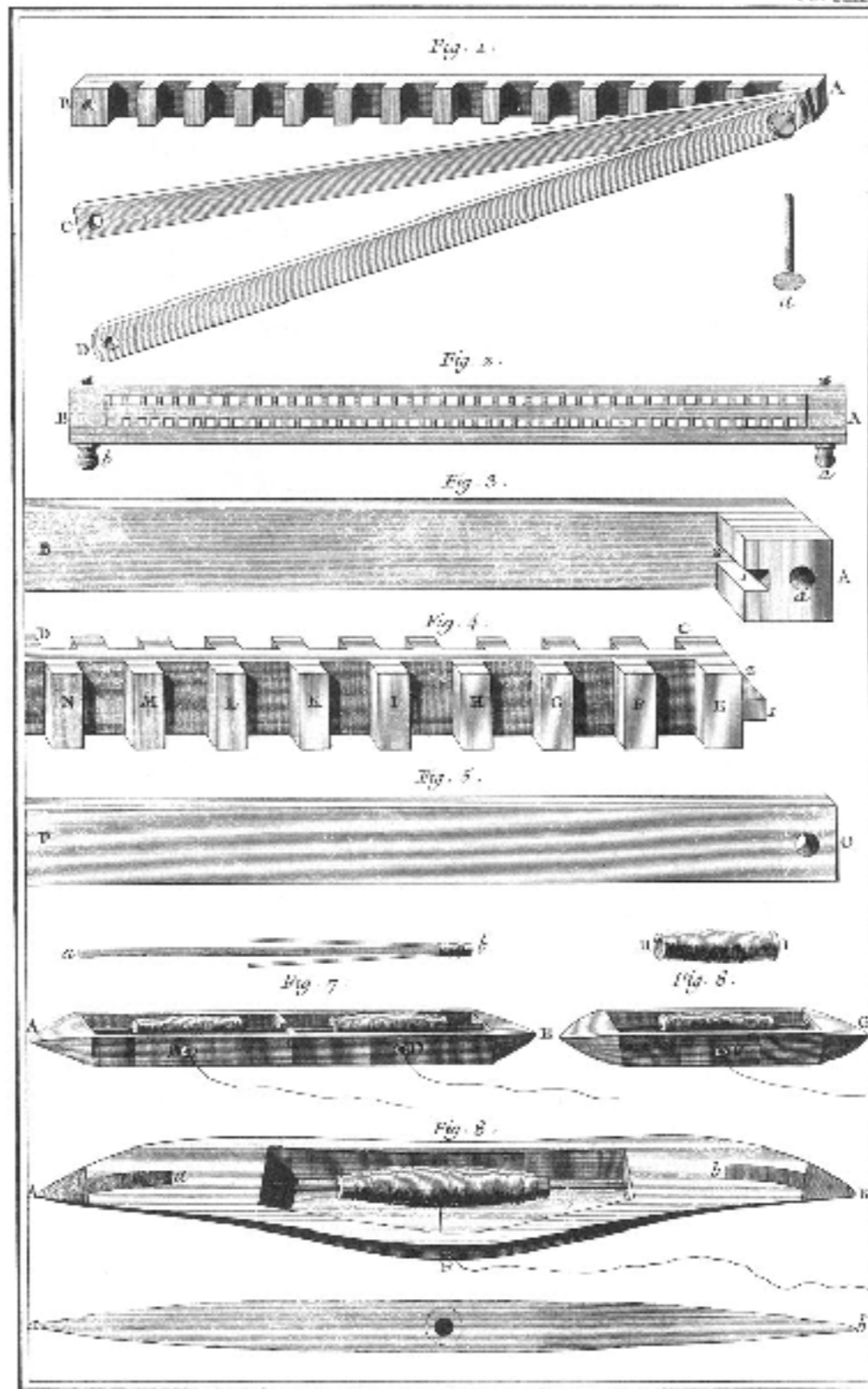

Soierie, Rascalettes, Espolins, Navette &c. 111

“Soierie, ...”

The Encyclopedia of Diderot & d'Alembert 1763  
(University of Michigan)

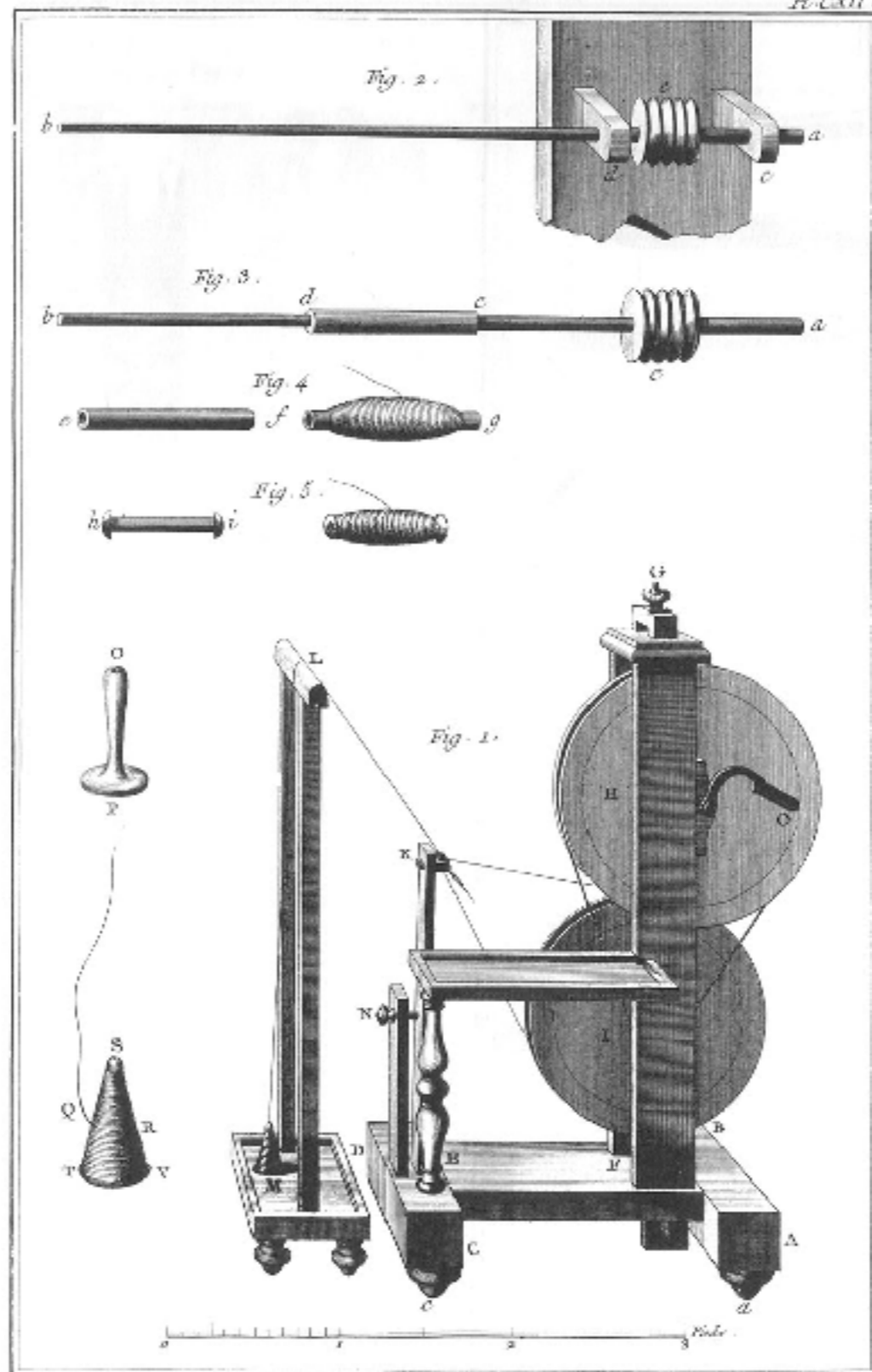

Benard Del.

Benard Fecit.

Soierie, Rouet à Cannelles

11 11 11

“Soierie, ...”

The Encyclopedia of Diderot & d'Alembert 1763  
(University of Michigan)

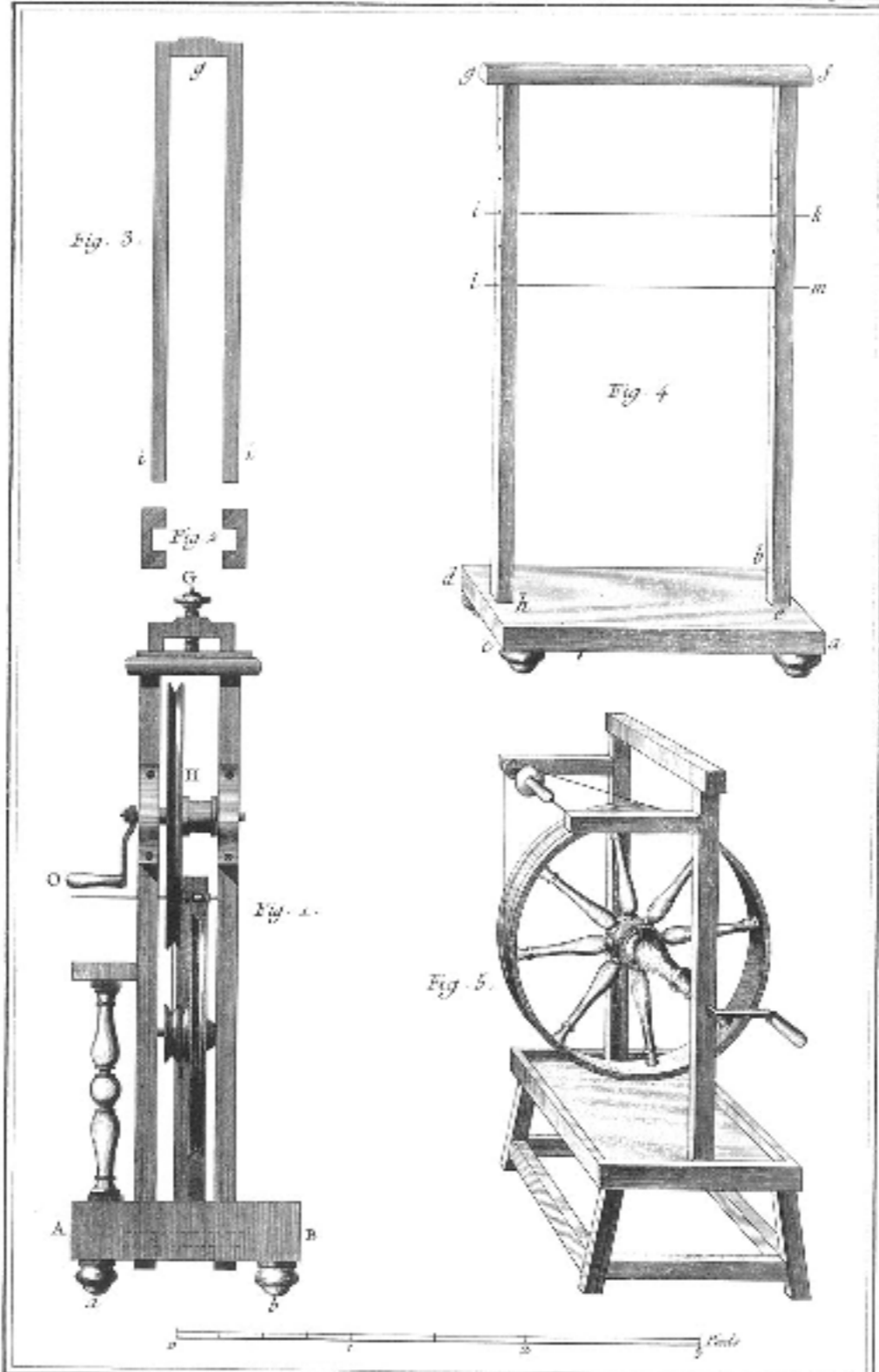

*Soierie,*  
*Développemens du Rouet à Canettes et le Rouet servant à garnir les Tôlans.*

“Soierie, ...”

The Encyclopedia of Diderot & d'Alembert 1763  
 (University of Michigan)

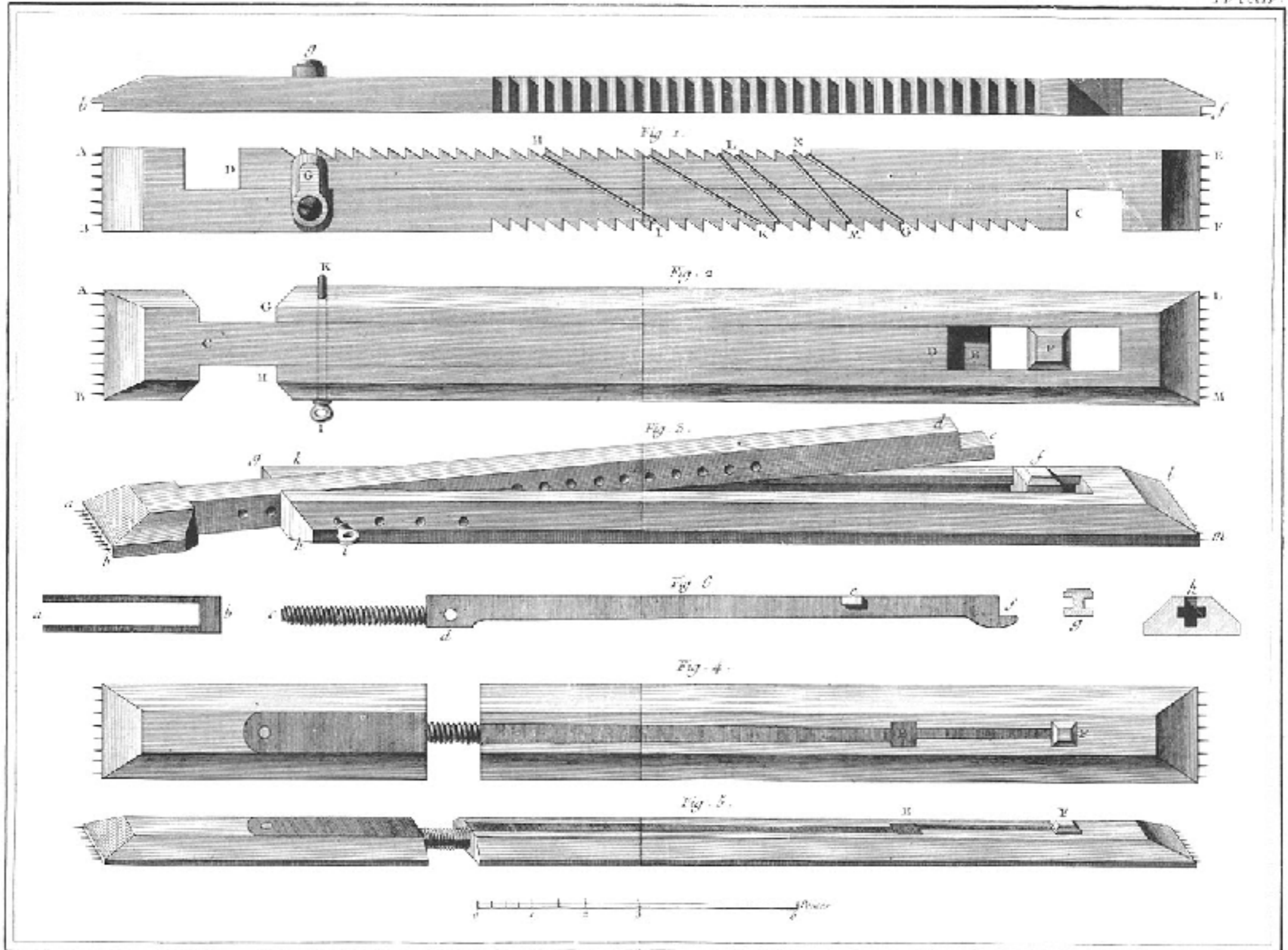

Gravé par M.

Benard del.

*Soierie, Tempia de différentes sortes, Tempia à Corde, Tempia à Bouton et Tempia à Vis.*

yyy

“Soierie, ...”

The Encyclopedia of Diderot & d'Alembert 1763  
(University of Michigan)

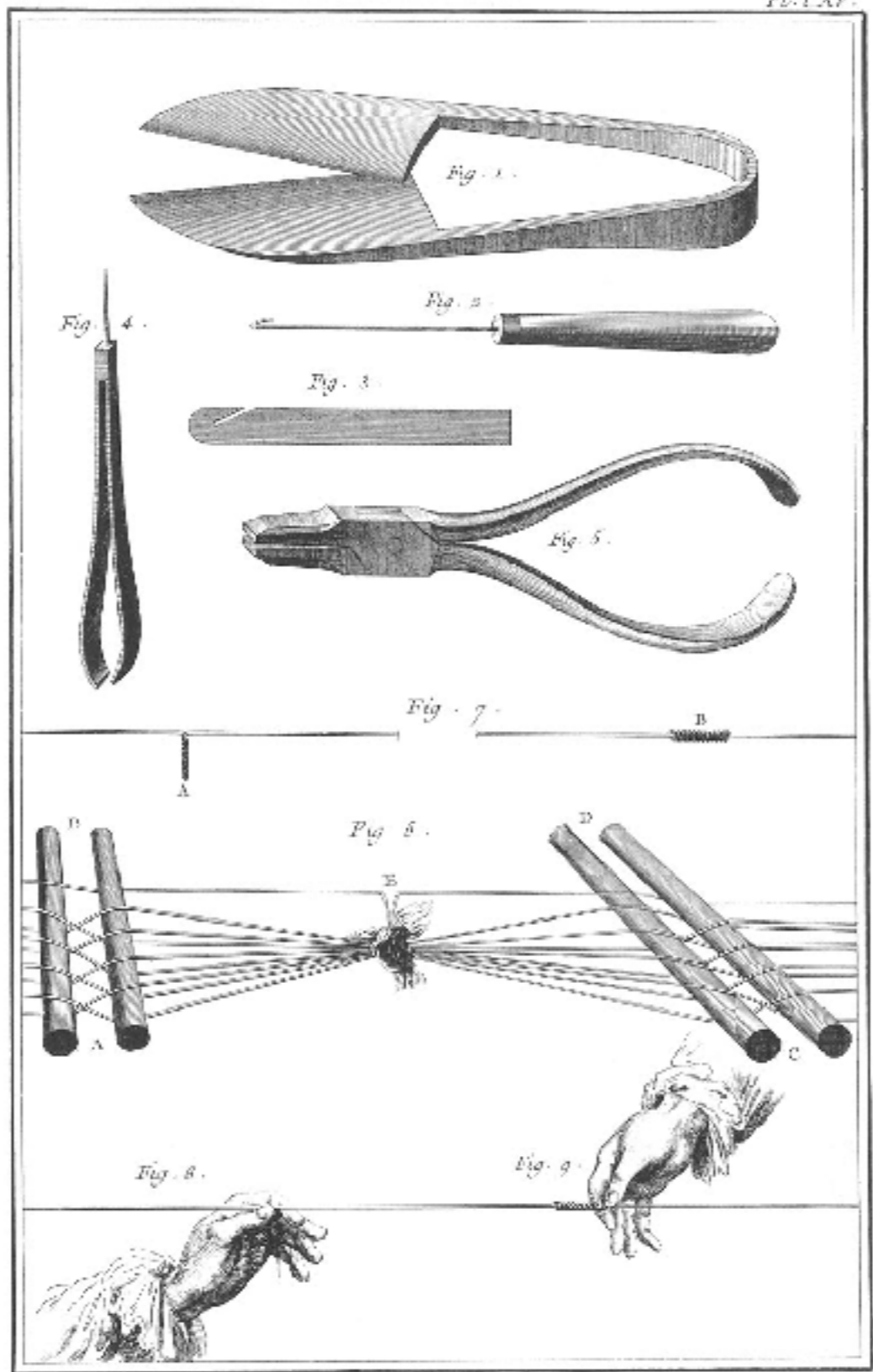

Genetier del. Dessin Exec.

Soierie, Différens Outils et Maniere de Tordre une nouvelle chaîne. L L L

“Soierie, ...”

The Encyclopedia of Diderot & d'Alembert 1763  
(University of Michigan)

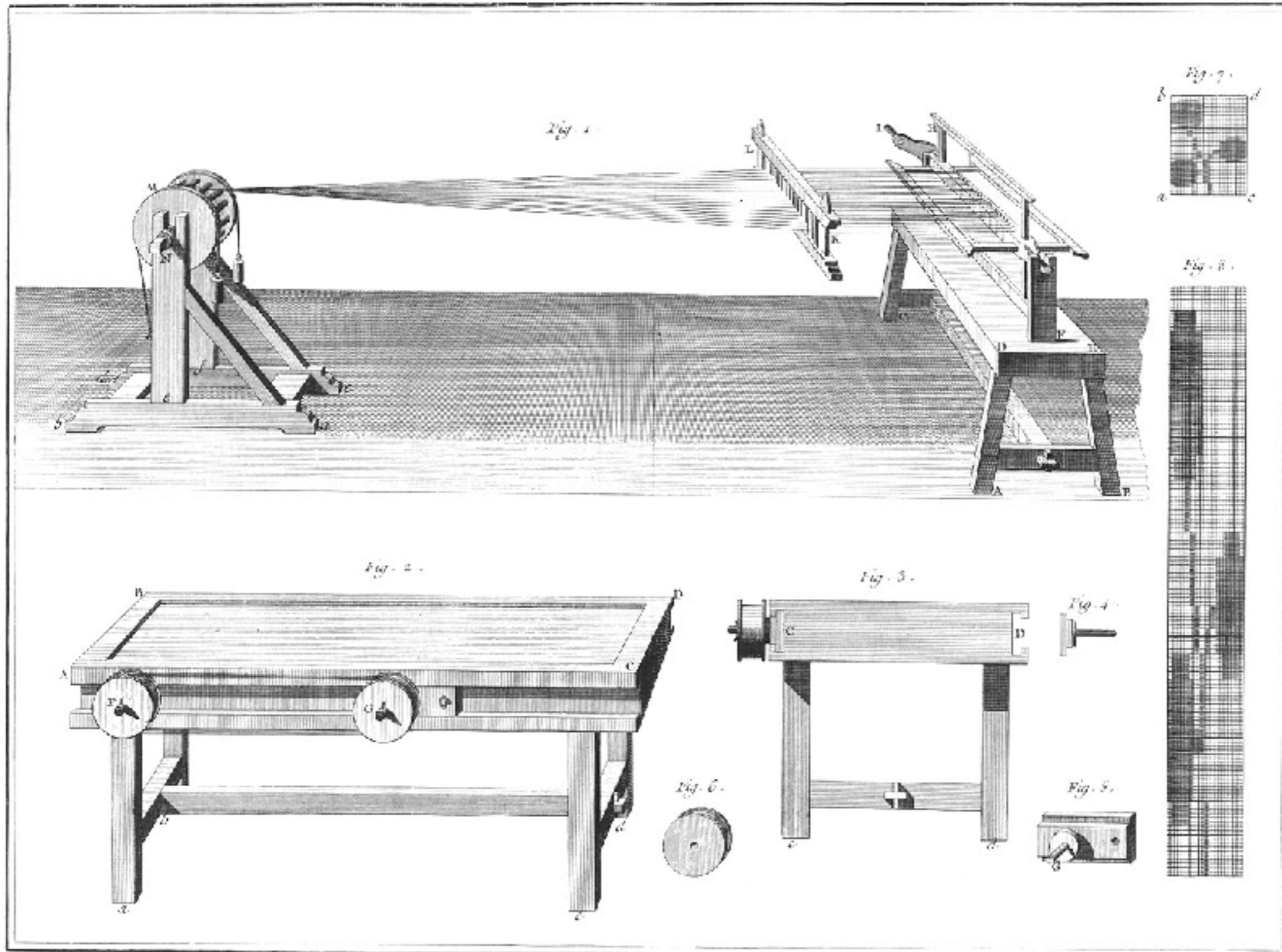

Benard del.

Benard fecit.

*Soierie, Chiner des Toffes.*

*Maniere de Chiner la Chaîne des Toffes, Développement de l'Etabli sur lequel on fait les Ligatures.*

aaaa

“Soierie, ...”

The Encyclopedia of Diderot & d'Alembert 1763  
(University of Michigan)

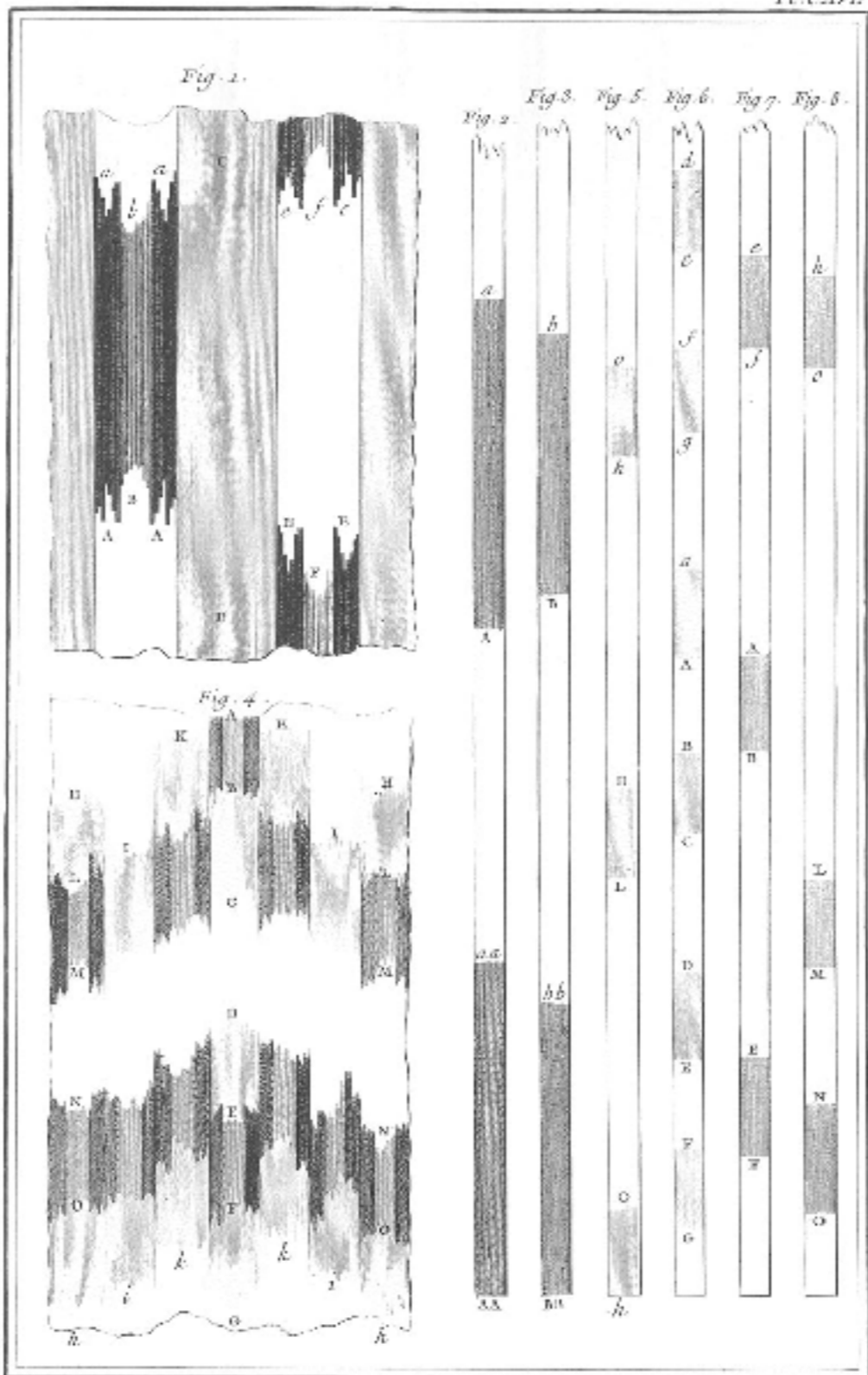

*Soierie, Chiner des Etoffes.*  
*Suite de la Maniere de Chiner la Chaîne des Etoffes.* bbbb

“Soierie, ...”

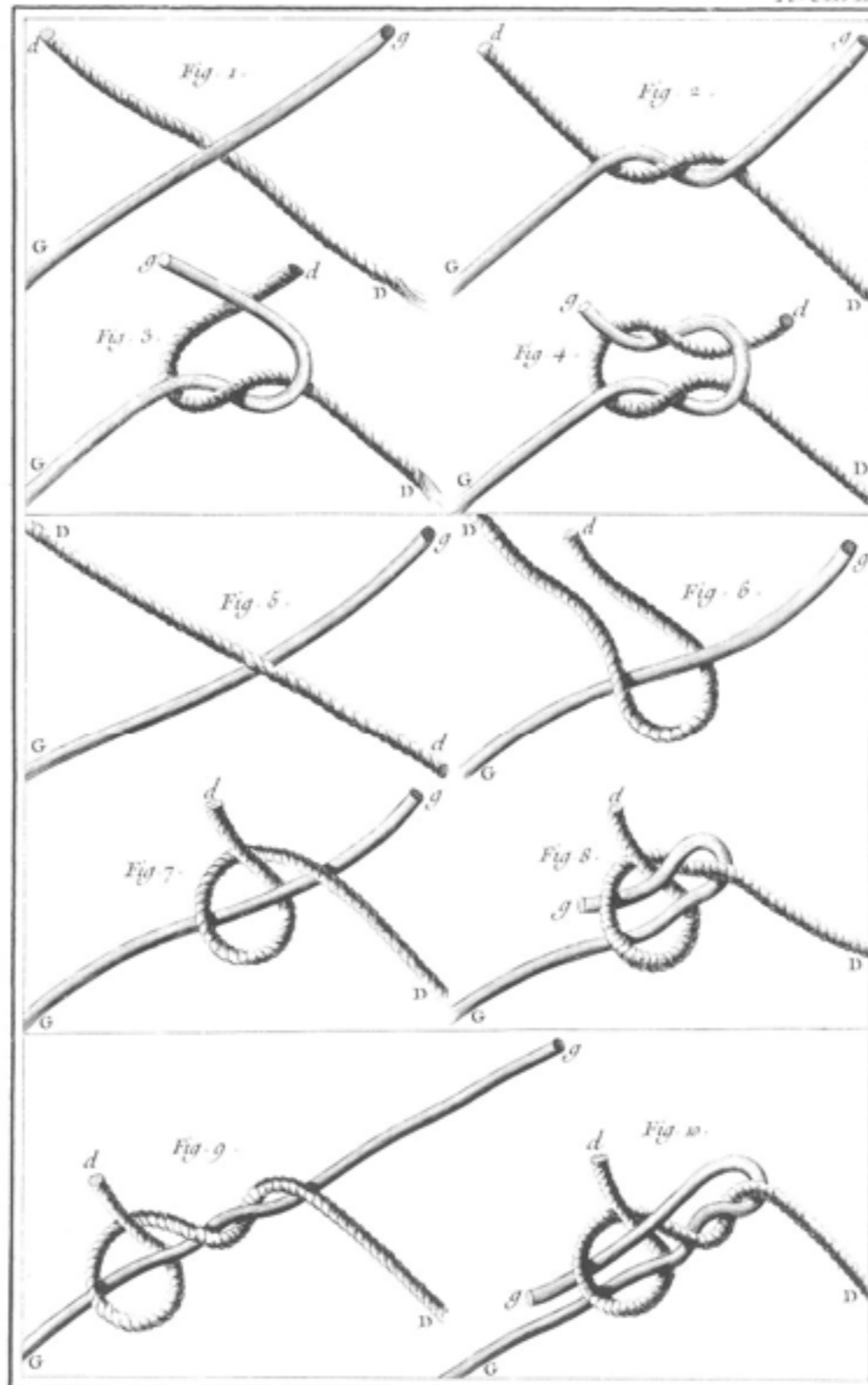

Beaumont Del.

Benard Fecit.

*Soierie, Nœud Plat, Nœud à l'angle et Nœud à l'angle Double cccc  
 les Différens temps de leur formation.*

“Soierie, ...”

The Encyclopedia of Diderot & d'Alembert 1763  
 (University of Michigan)

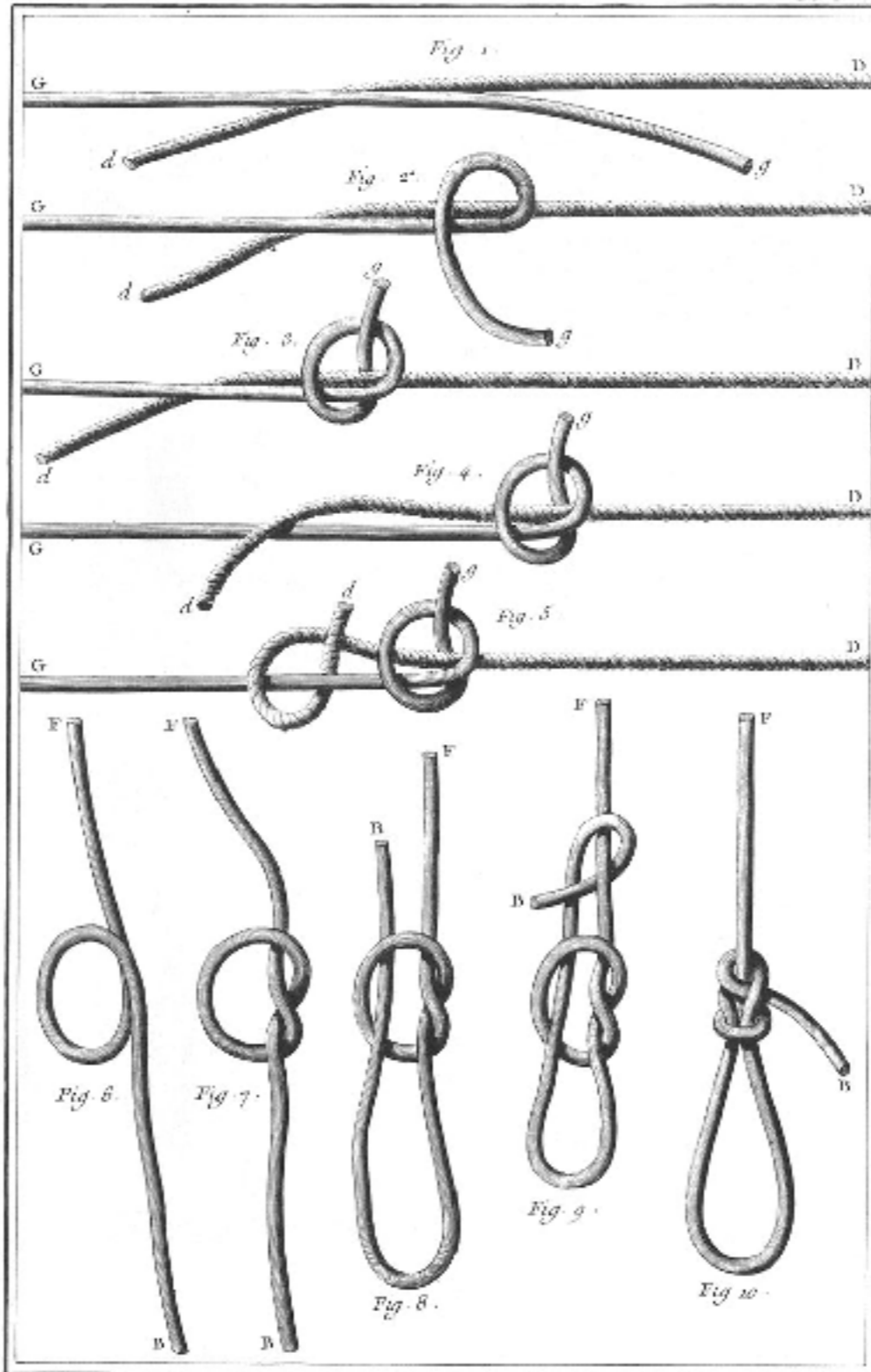

Goussier Del.

Bourd Grav.

*Soierie, Noeud Tirant et Noeud Coulant, les différents temps de leur formation.*

*dddd*

“Soierie, ...”

The Encyclopedia of Diderot & d'Alembert 1763  
(University of Michigan)

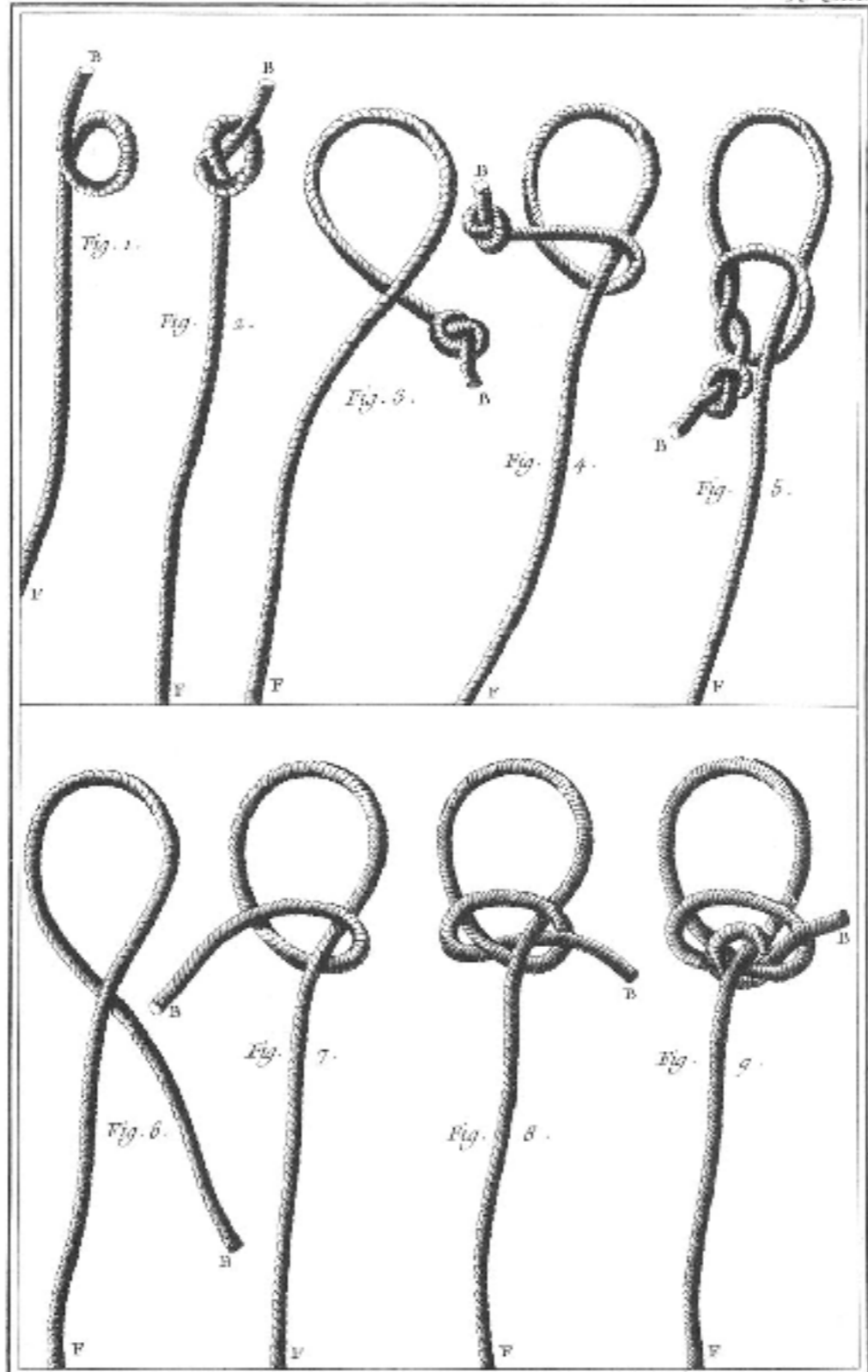

Demour Inel

Bernard Picot

*Soierie, Nœud Coulant à Boucle et Nœud Coulant ordinaire, eeee les différents temps de leur formation.*

“Soierie, ...”

The Encyclopedia of Diderot & d'Alembert 1763  
(University of Michigan)

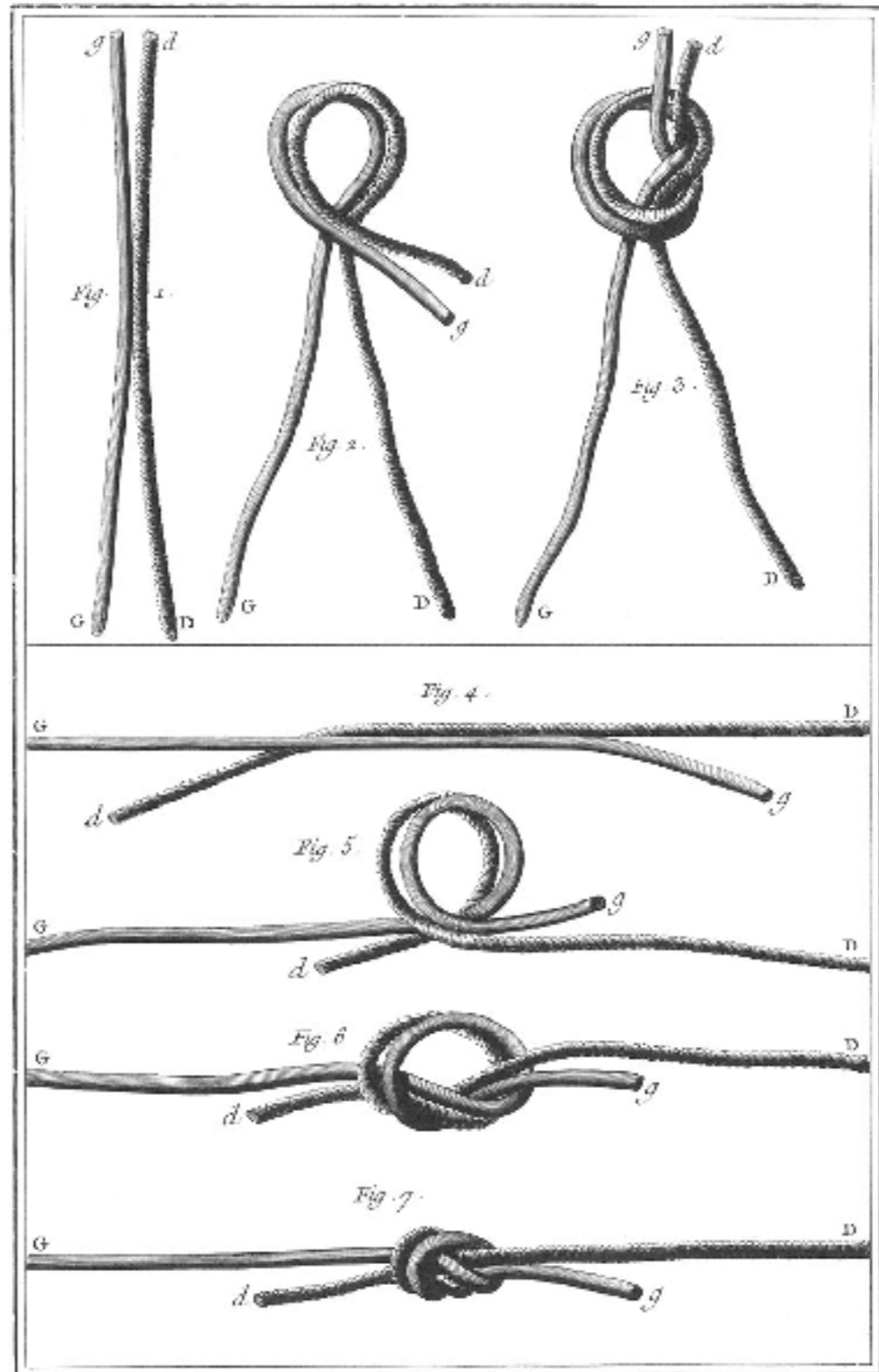

Belloc Del.

Beaud Fris.

*Soierie, nœuds à petites queues et à grandes queues. les différens temps de leur formation.*

SSS

“Soierie, ...”

The Encyclopedia of Diderot & d'Alembert 1763  
(University of Michigan)

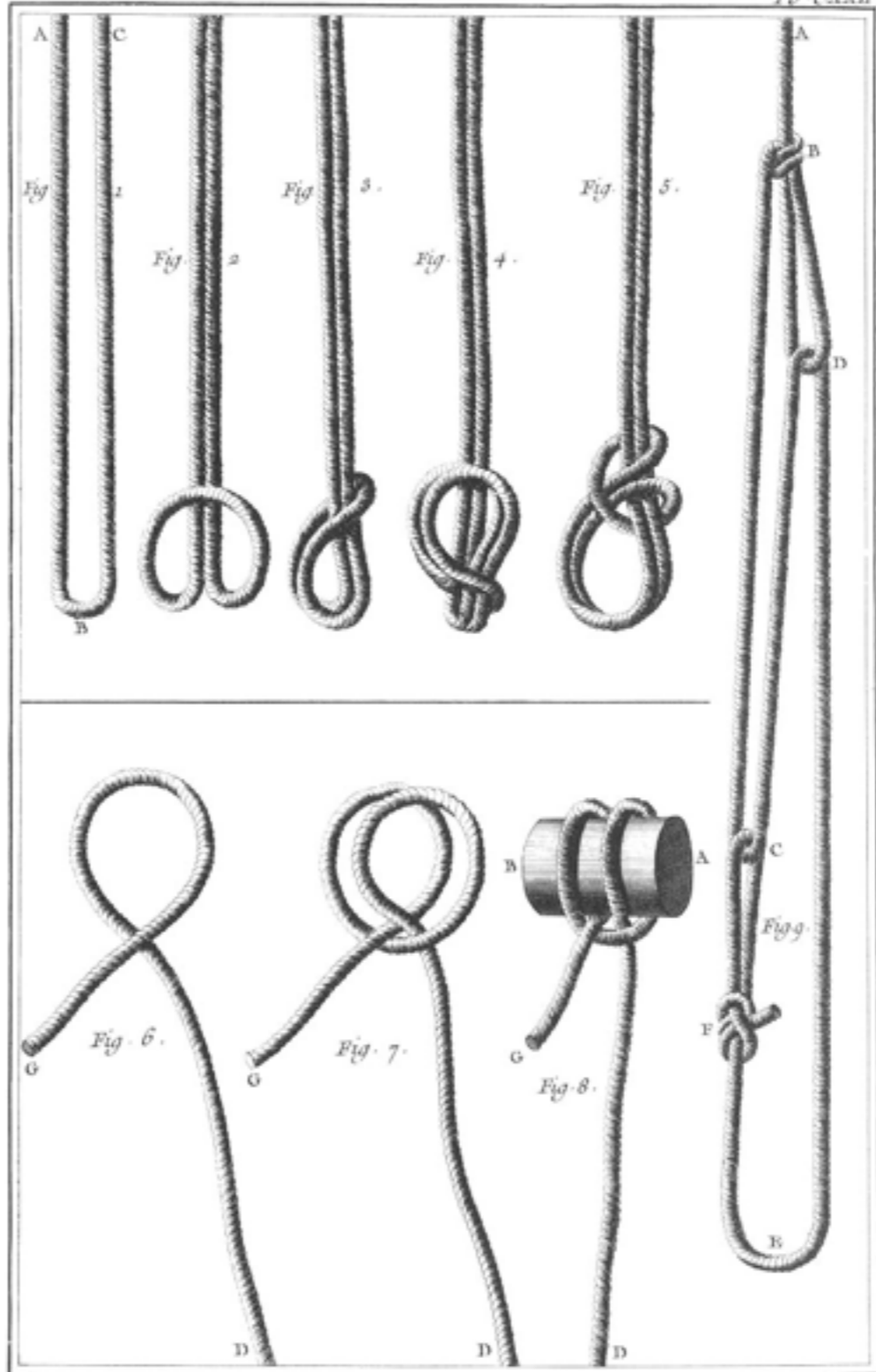

*Soierie*, Noeud de Sangle et de Rame ou à double Boucle, Noeud de la Charrue, Noeud à Crémaillère. les différens temps de leur formation. 9999

“Soierie, ...”

The Encyclopedia of Diderot & d'Alembert 1763  
(University of Michigan)

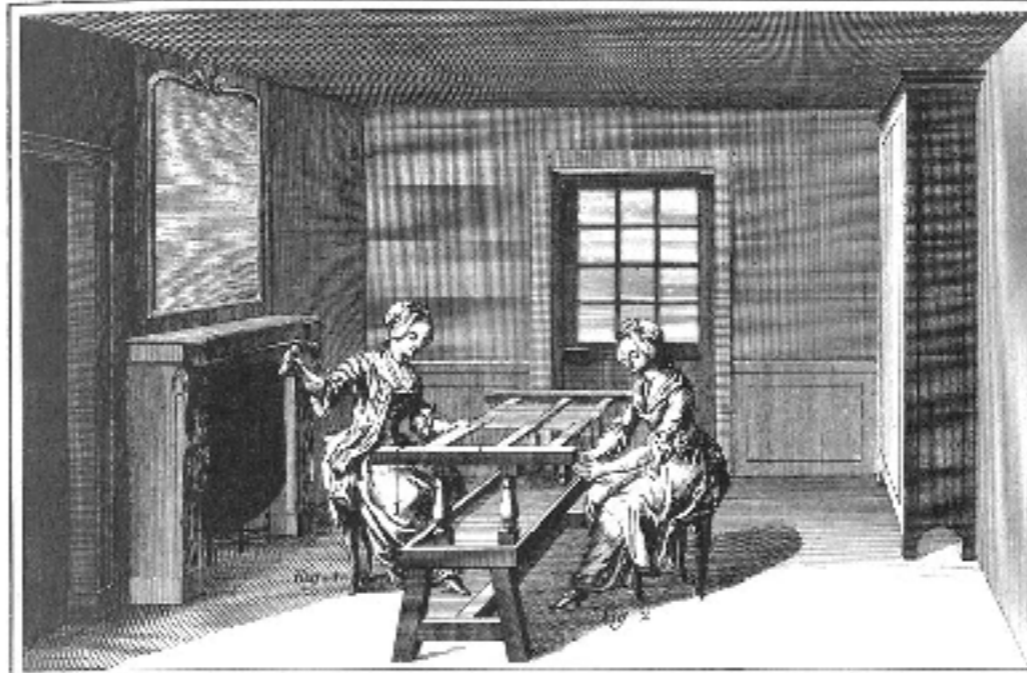
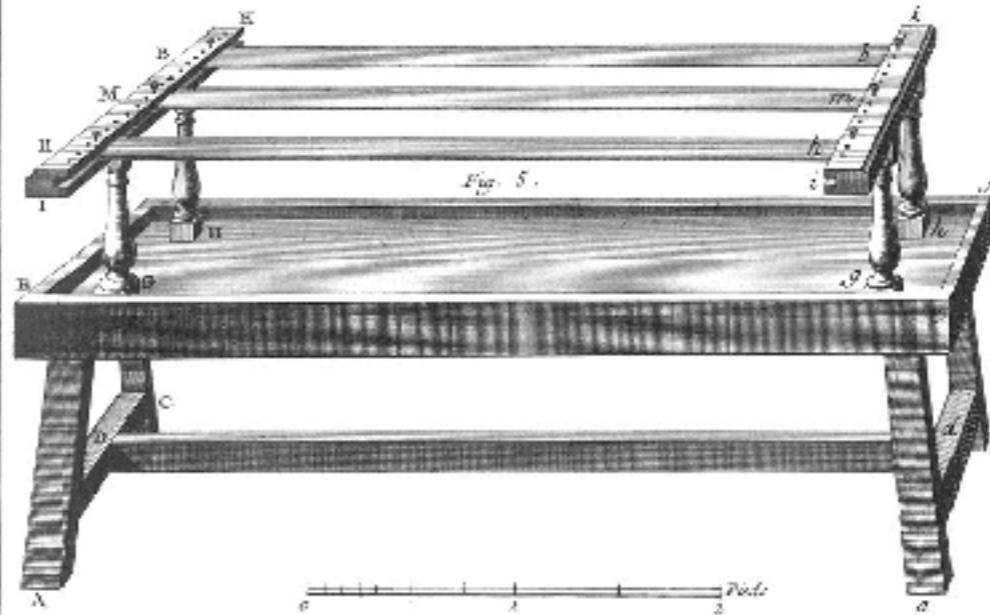

Fig. 3.



Fig. 4.



CHASSIN DEL.

LOUIS BOIS

Soierie, Fabrication des Verses et le Lissoir en Perspective.

h.h.h.h

“Soierie, ...”

The Encyclopedia of Diderot & d'Alembert 1763  
(University of Michigan)

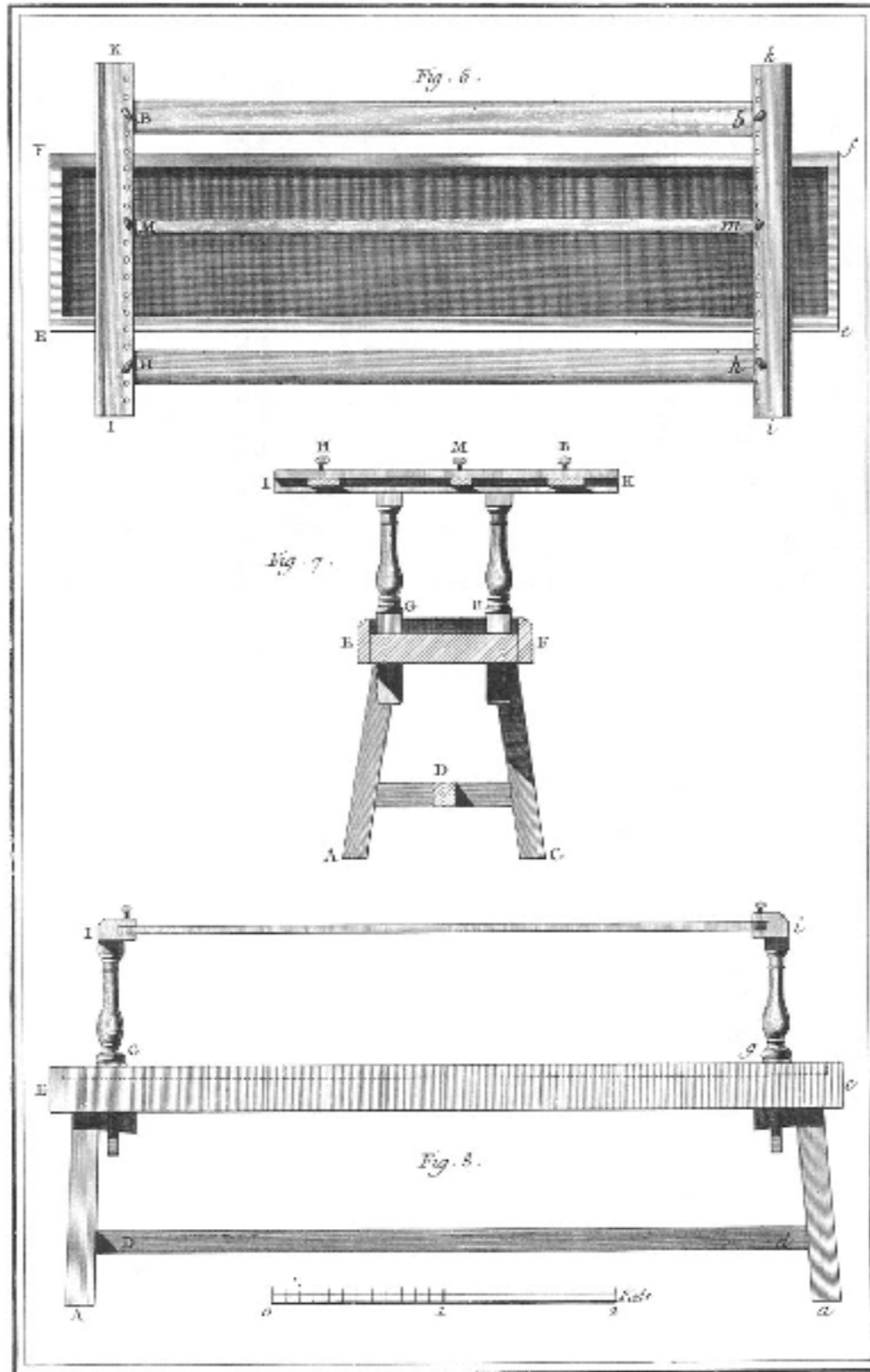

Guarneri Del.

Benard Sculp.

Soierie, développemens du Lassoir.

iii

“Soierie, ...”

The Encyclopedia of Diderot & d'Alembert 1763  
(University of Michigan)

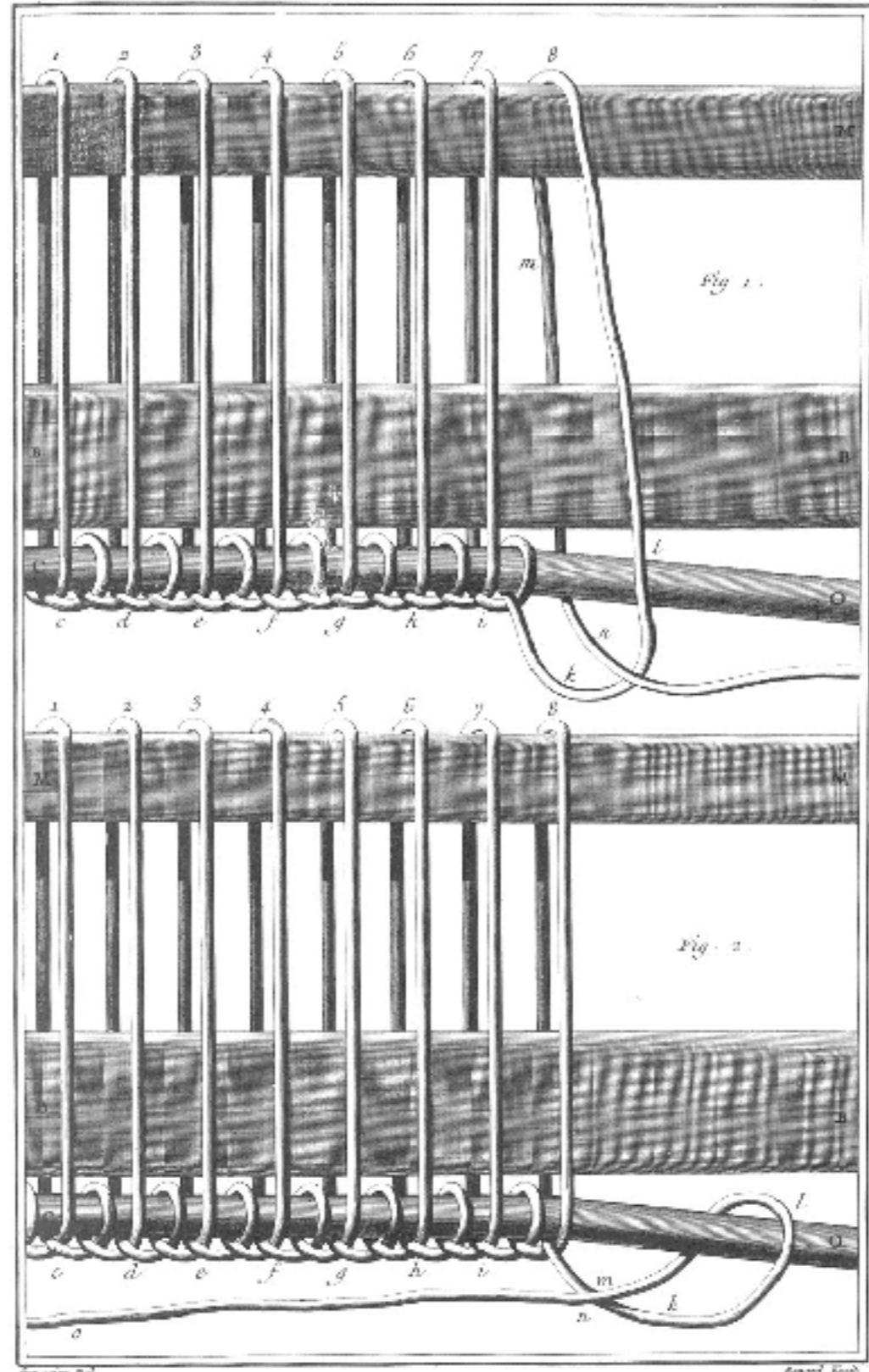

*Soierie, Formation du Bas des Lissas et Maniere de Natter. kkkk*

“Soierie, ...”

The Encyclopedia of Diderot & d'Alembert 1763  
(University of Michigan)

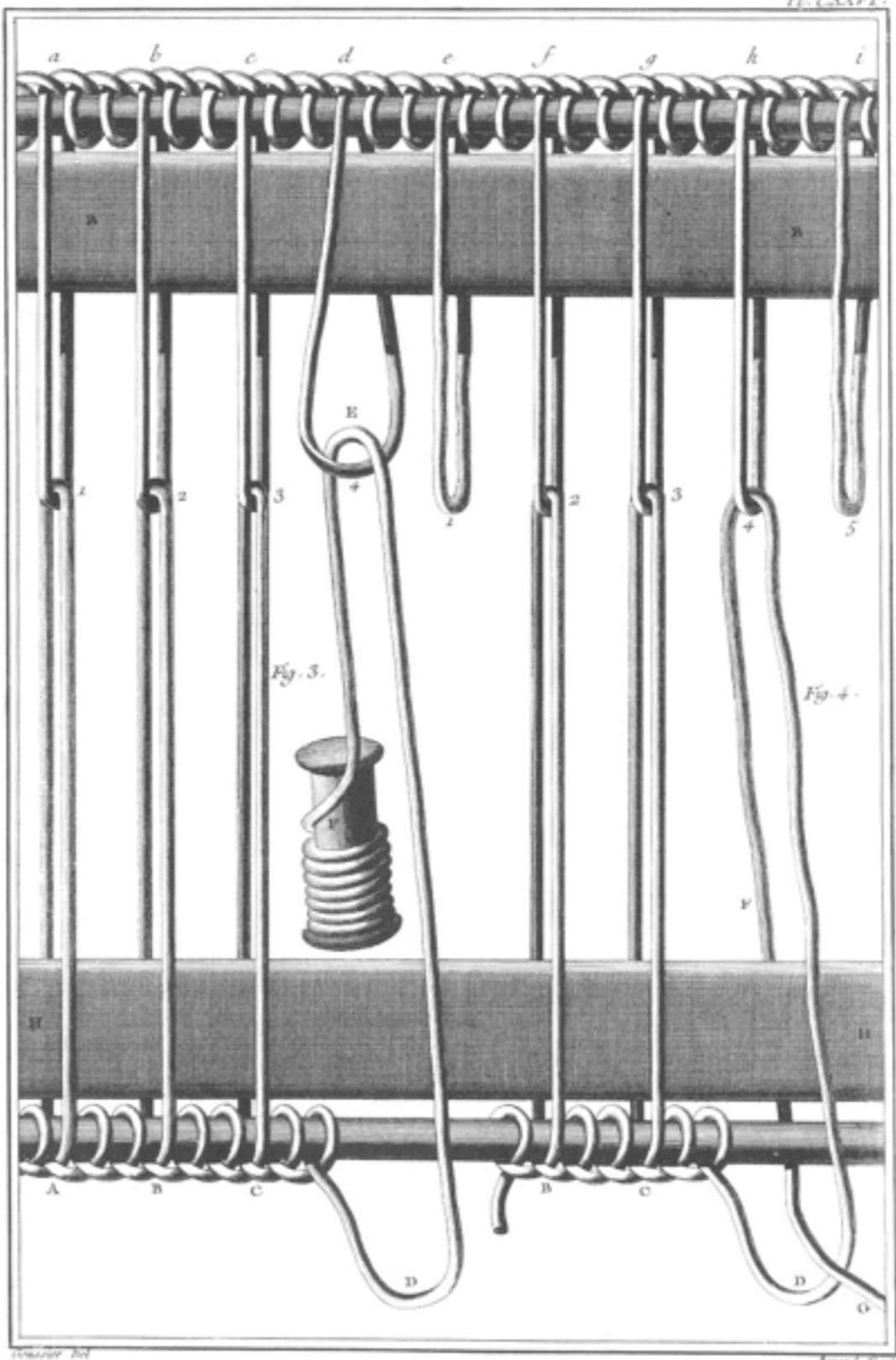

*Soierie Tissus à Crochets ; premier et second temps de la formation de la Maille . IIII*

“Soierie, ...”

The Encyclopedia of Diderot & d'Alembert 1763  
(University of Michigan)

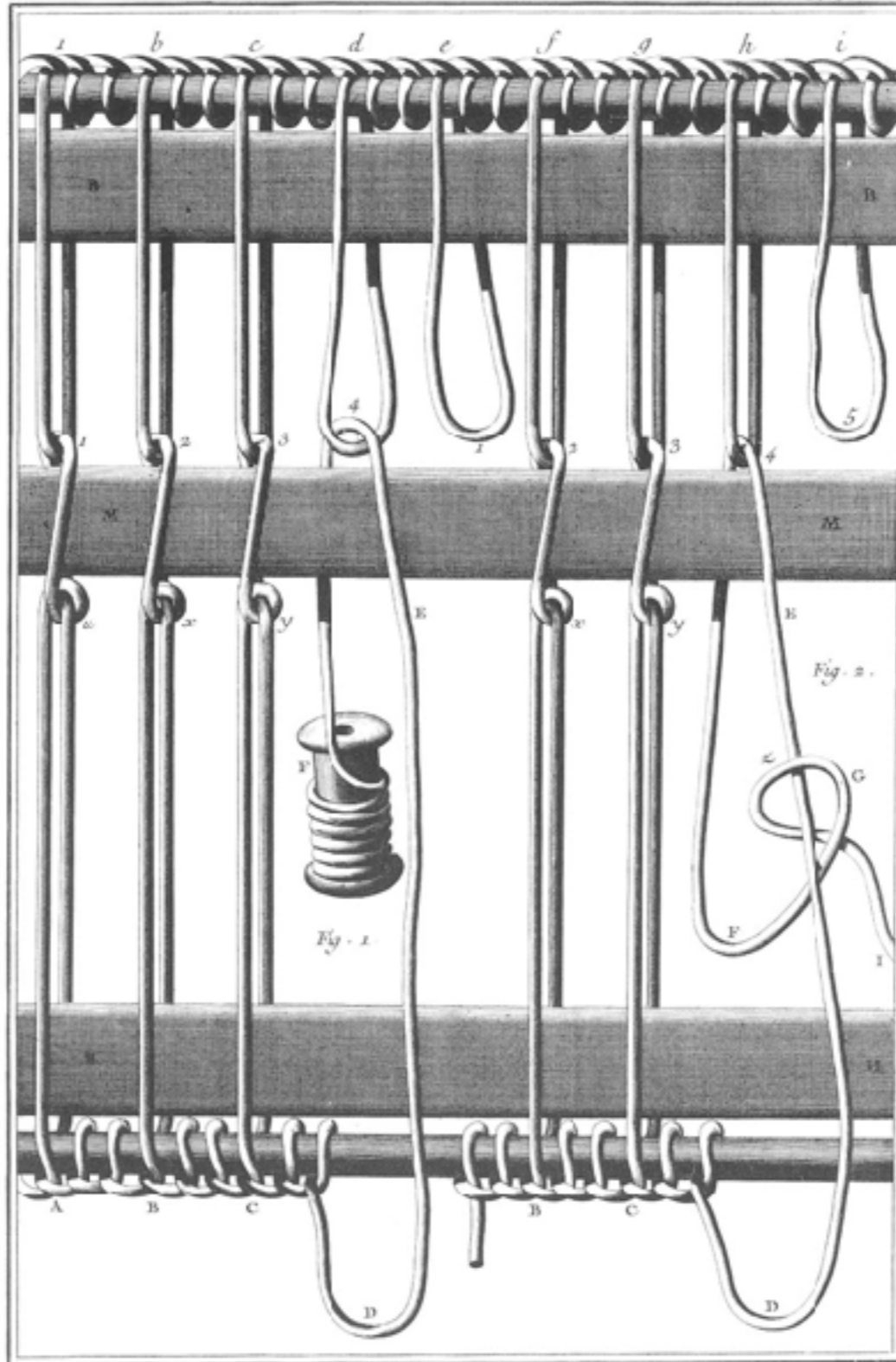

Deuxier Del.

Benard Scul.

*Soierie, Lisses à noeuds premier et second temps de la formation de la maille.*

m m m m

“Soierie, ...”

The Encyclopedia of Diderot & d'Alembert 1763  
(University of Michigan)

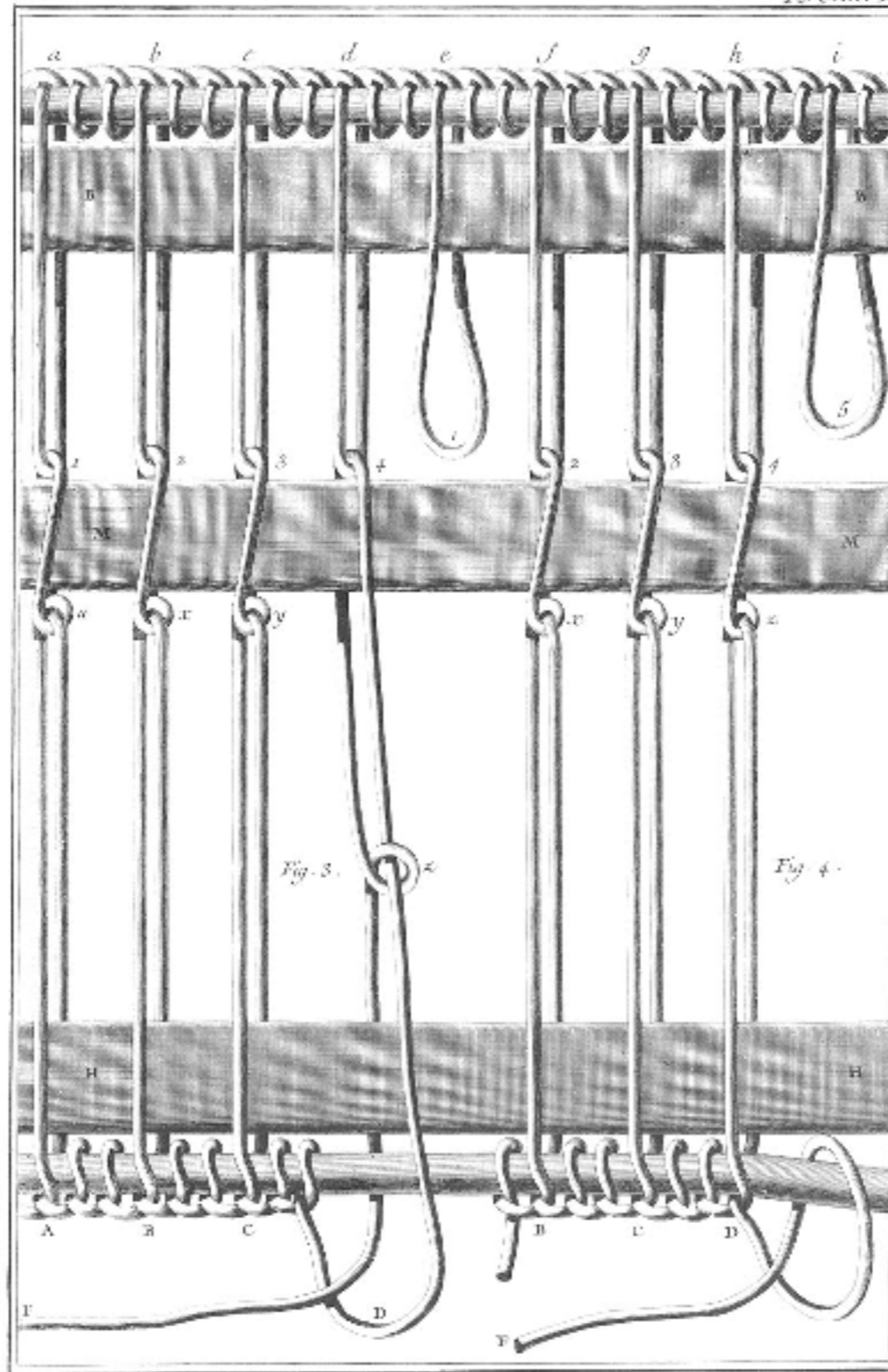

Soierie, Lissas à Nœuds, troisième et quatrième temps de la formation de la maille. R. R. R. R.

“Soierie, ...”

The Encyclopedia of Diderot & d'Alembert 1763  
(University of Michigan)

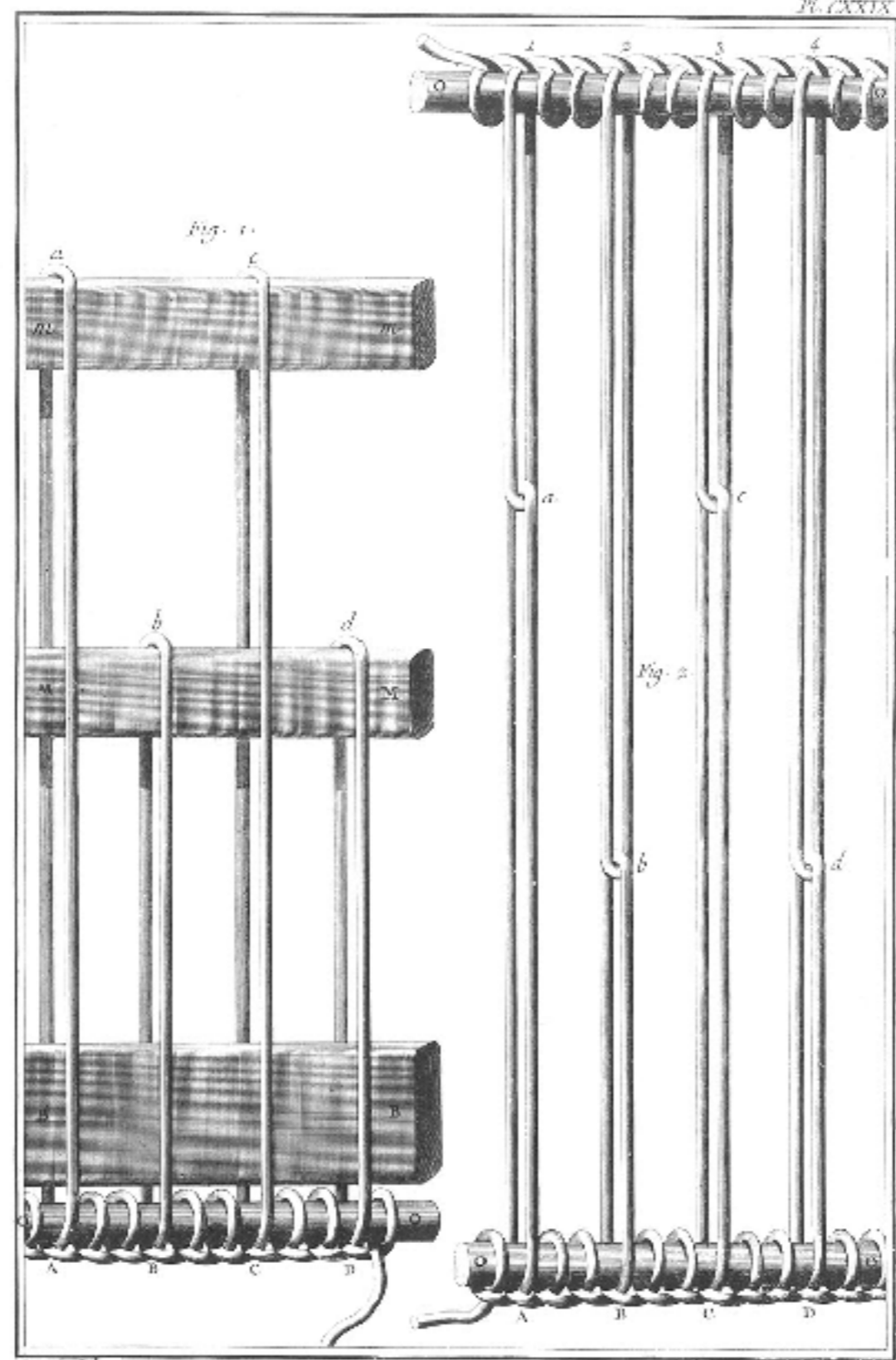

*Soierie, Lisses à Grand Colisse.*

o o o o

“Soierie, ...”

The Encyclopedia of Diderot & d'Alembert 1763  
(University of Michigan)

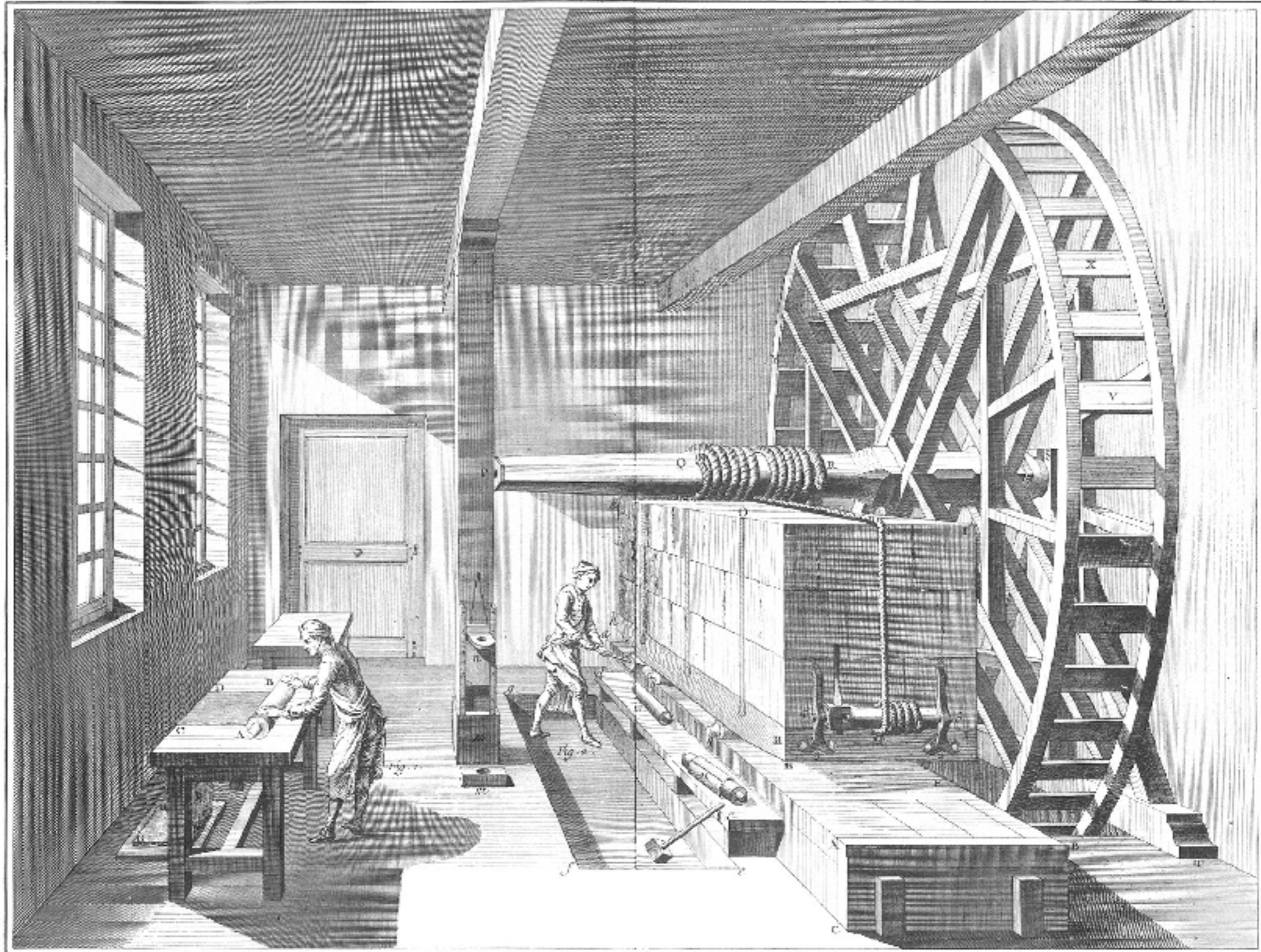

*Soierie, Calandre, Calandre Vue en Perspective, et l'Operation de Calandrer*

Bouard Sculp.

pppp

“Soierie, ...”

The Encyclopedia of Diderot & d'Alembert 1763  
(University of Michigan)

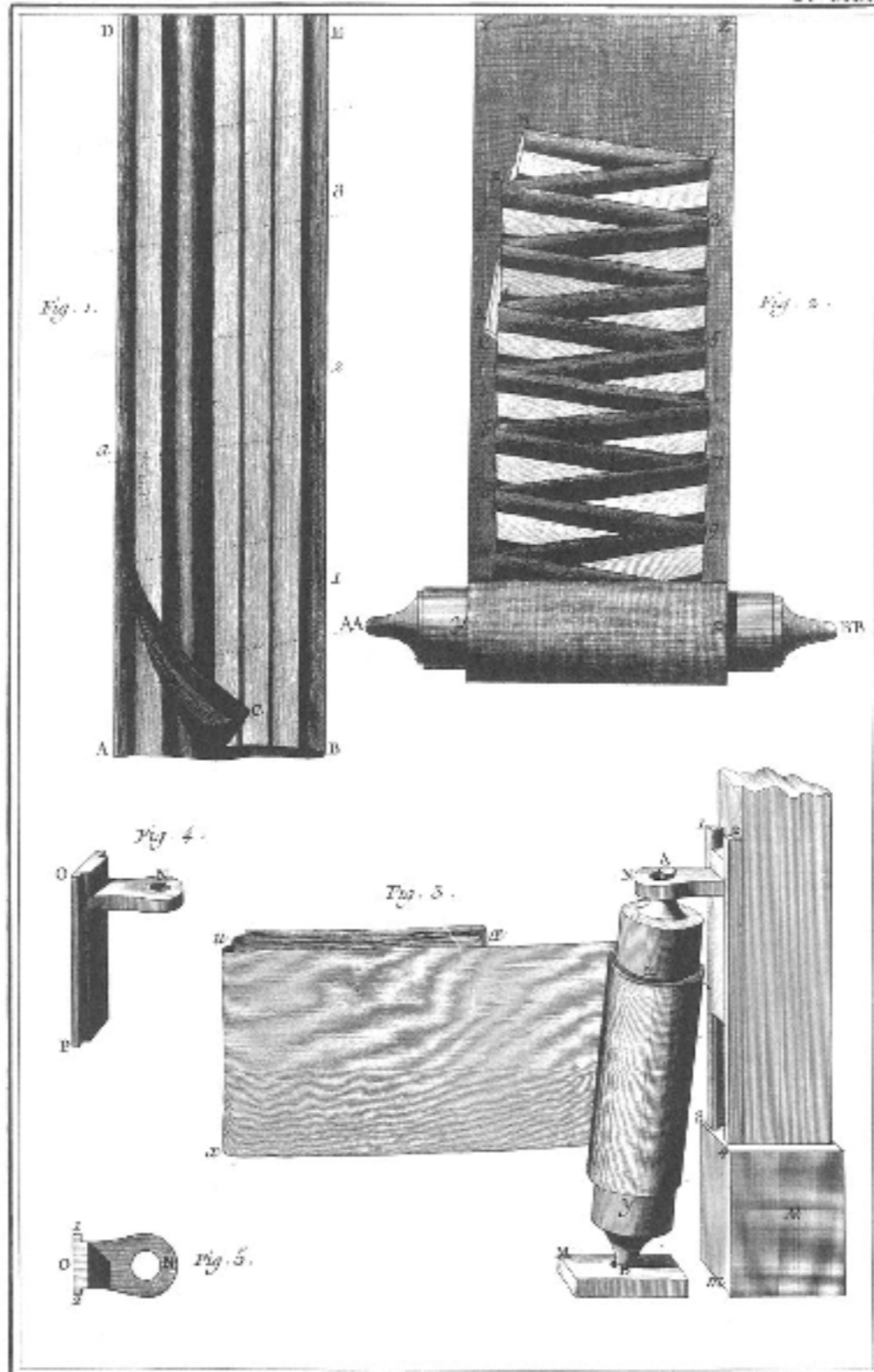

*Soierie, Calandre. Maniere de Ployer les Etoffes qui doivent être Mairées et Développement et usage du Valet.*

“Soierie, ...”

The Encyclopedia of Diderot & d'Alembert 1763  
(University of Michigan)

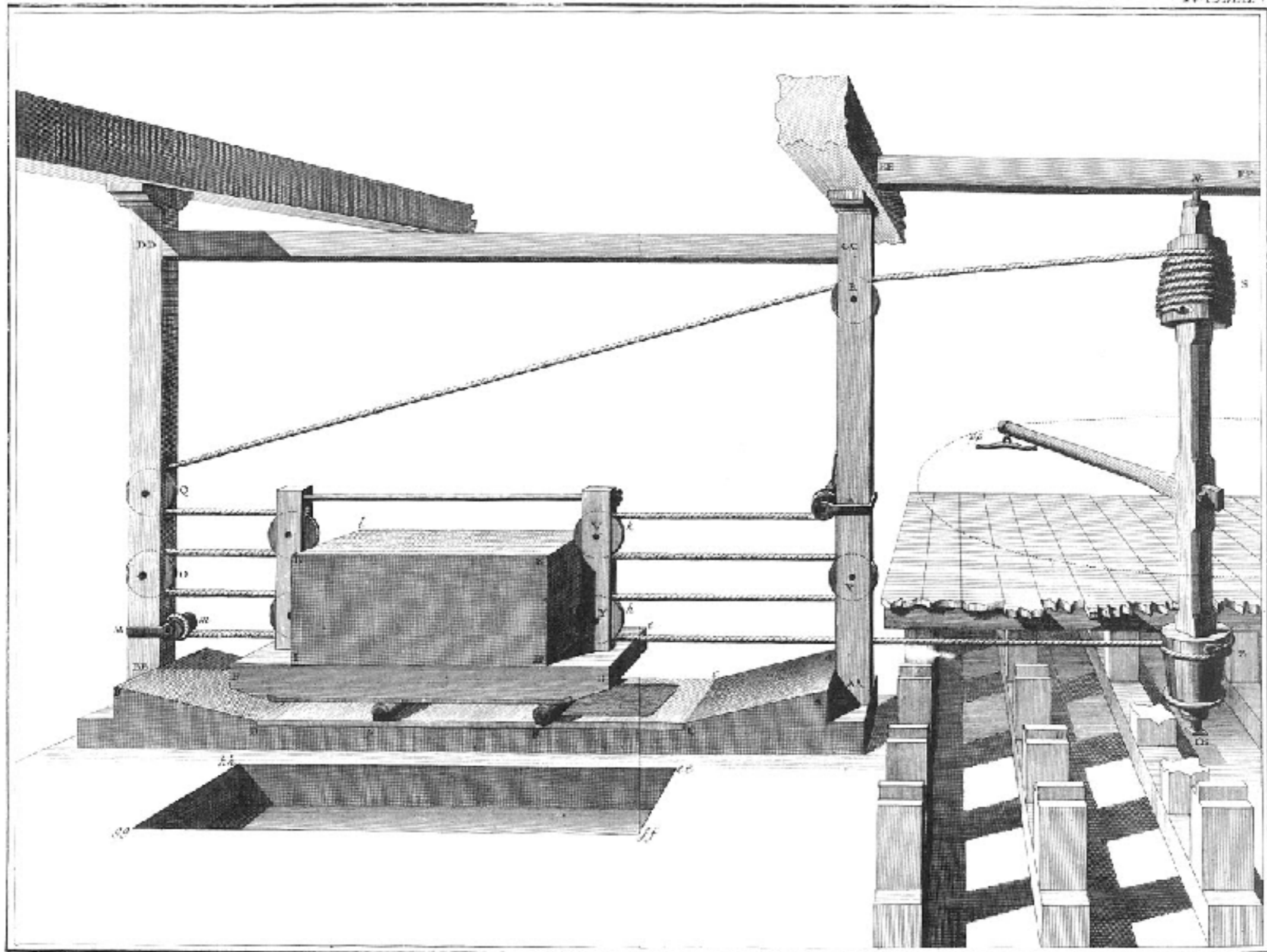

*Soierie, Calandre Royale ou Calandre Angloise.*

1777

“Soierie, ...”

The Encyclopedia of Diderot & d'Alembert 1763  
(University of Michigan)

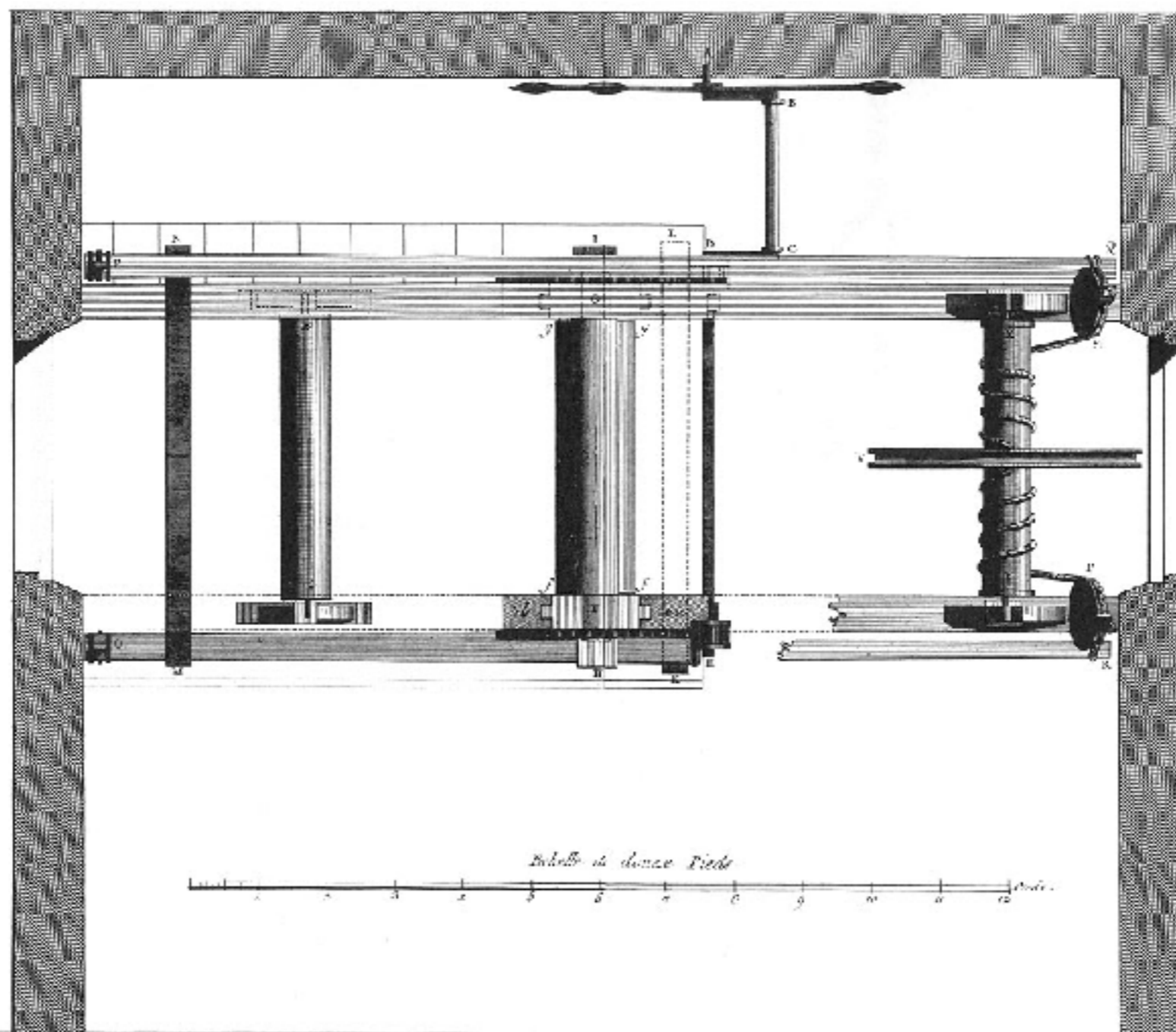

Benard del.

Benard fecit.

*Soierie, Plan de la Machine servant à Cilindrer les Étoffes.*

1756

“Soierie, ...”

The Encyclopedia of Diderot & d'Alembert 1763  
(University of Michigan)

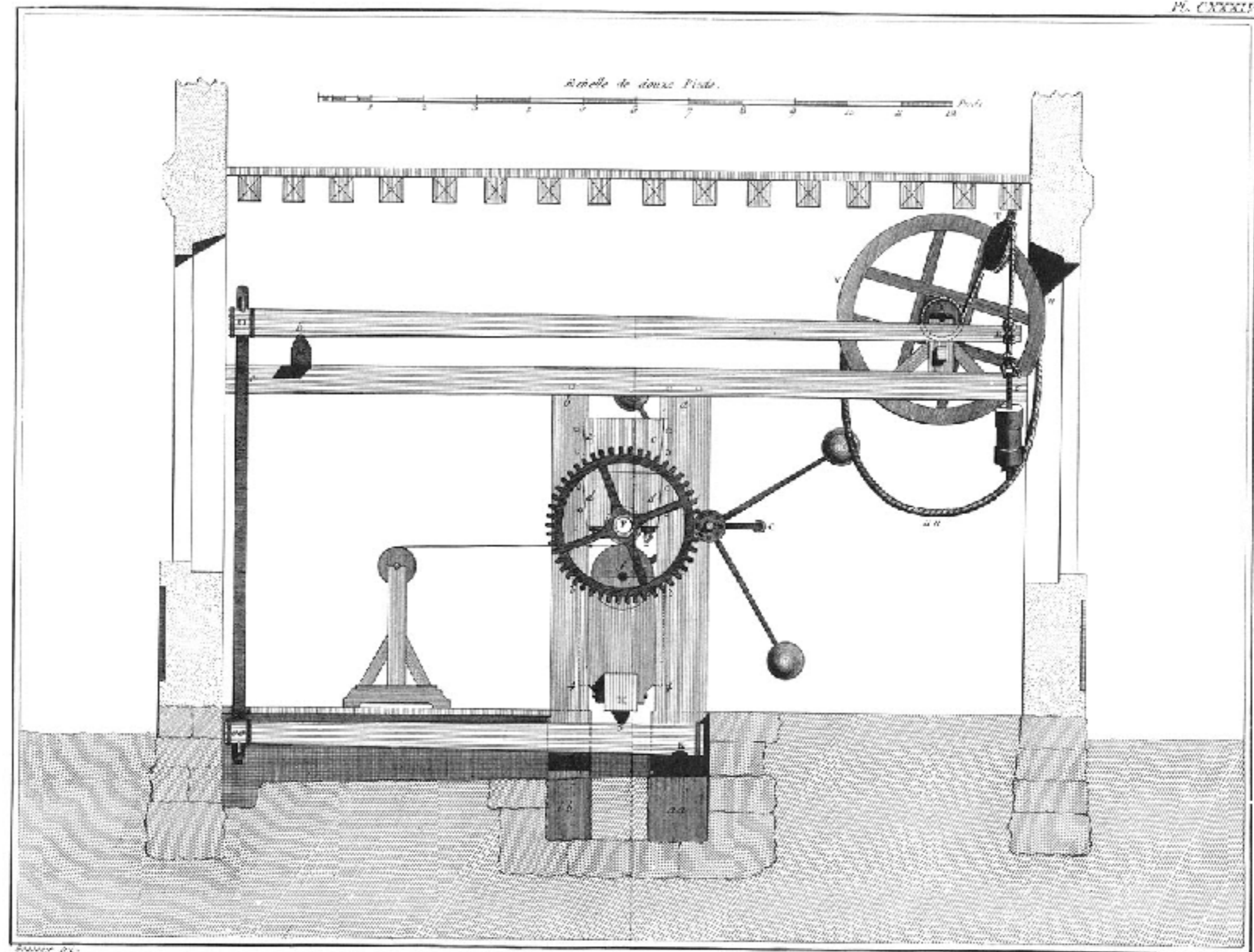

*Soierie, Élevation Latérale de la Machine servant à cylindrer les Étoffes.*

litt

“Soierie, ...”

The Encyclopedia of Diderot & d'Alembert 1763  
(University of Michigan)

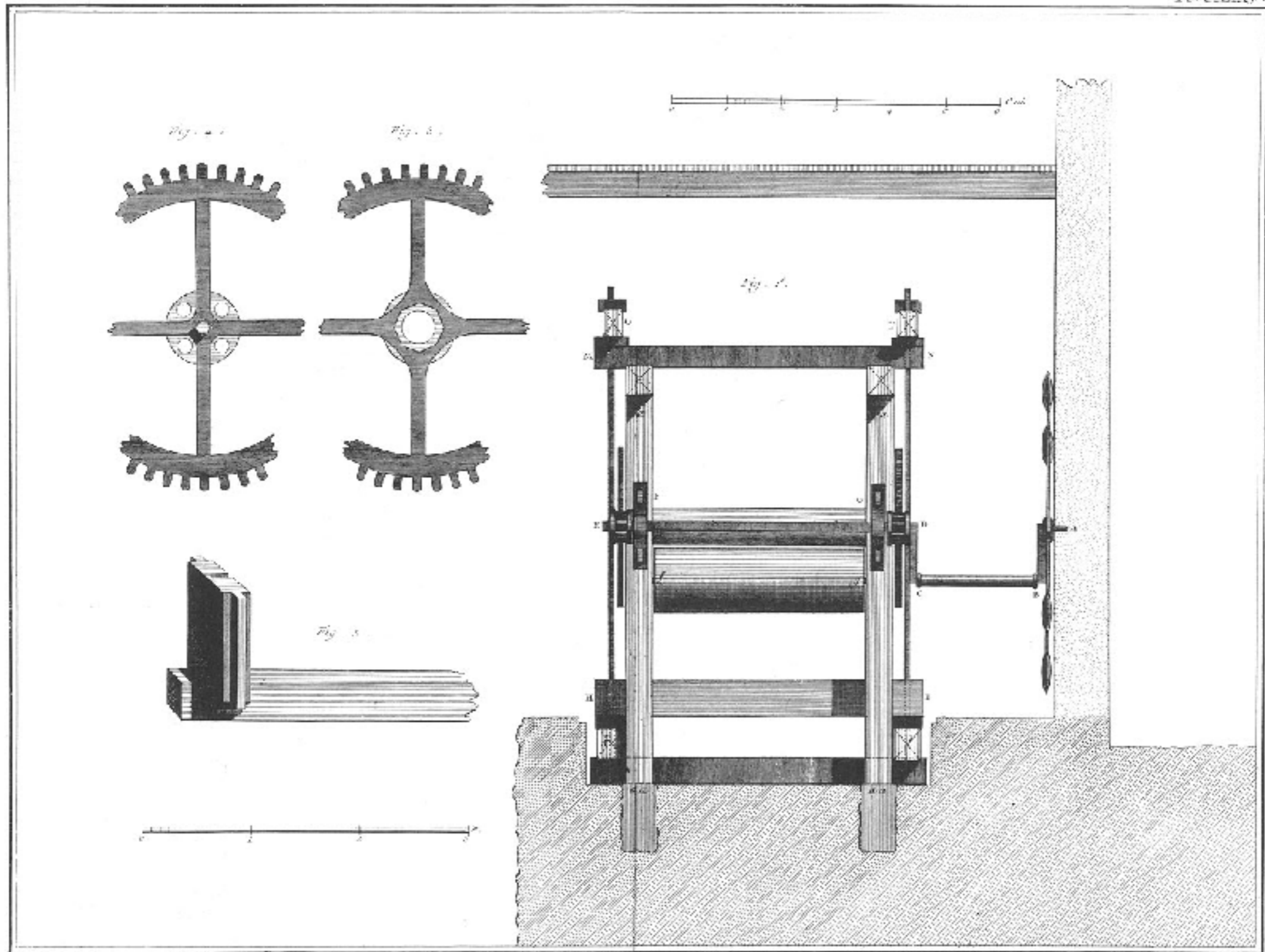

BOUILLON DEL.

ROBERT FINE

*Soierie, Révélation antérieure de la Machine servant à dévider les Bâffes et Développemens de quelques uns de ses Parties. U U U U*

“Soierie, ...”

The Encyclopedia of Diderot & d'Alembert 1763  
(University of Michigan)

# Silk or River Dyer

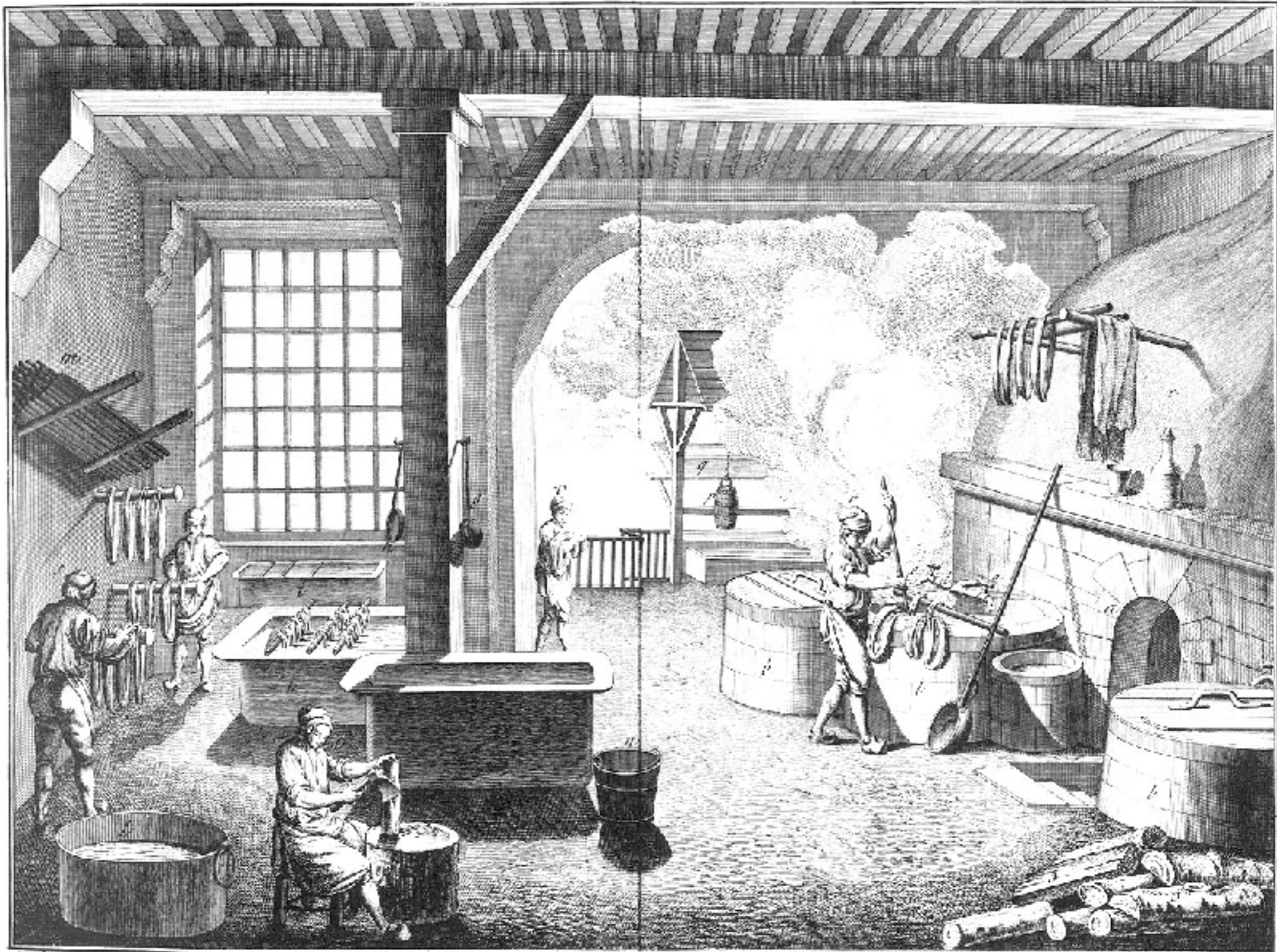

*Teinturier de Riviere, Atelier et différentes Opérations pour la Teinture des Soies*

“Teinlurier de Riviere,, ...”  
The Encyclopedia of Diderot & d'Alembert 1763  
(University of Michigan)

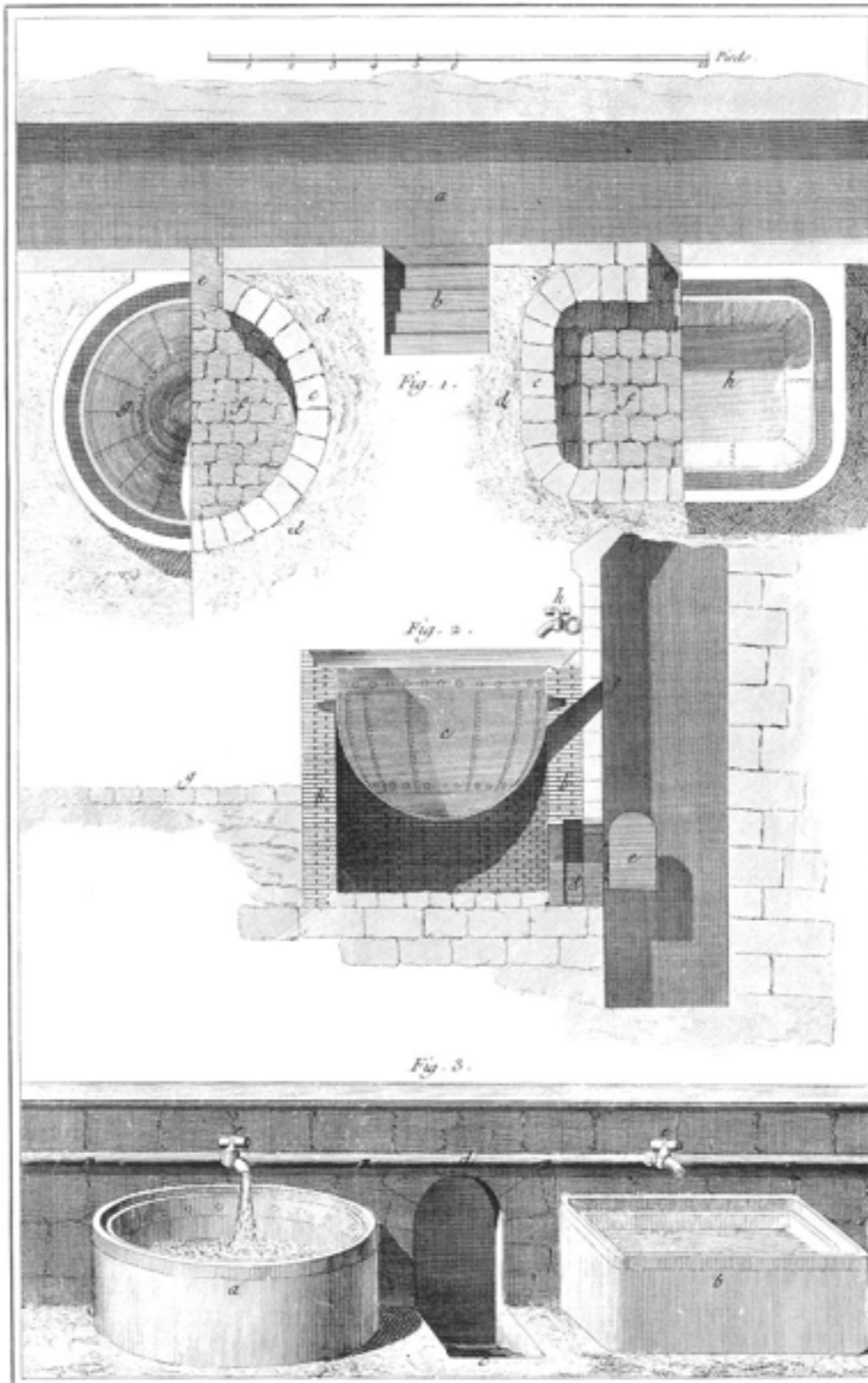

*Teinturier de Riviere, plans, coupe et élévations de différentes Chaudières.*

“Teinlurier de Riviere,, ...”  
 The Encyclopedia of Diderot & d'Alembert 1763  
 (University of Michigan)

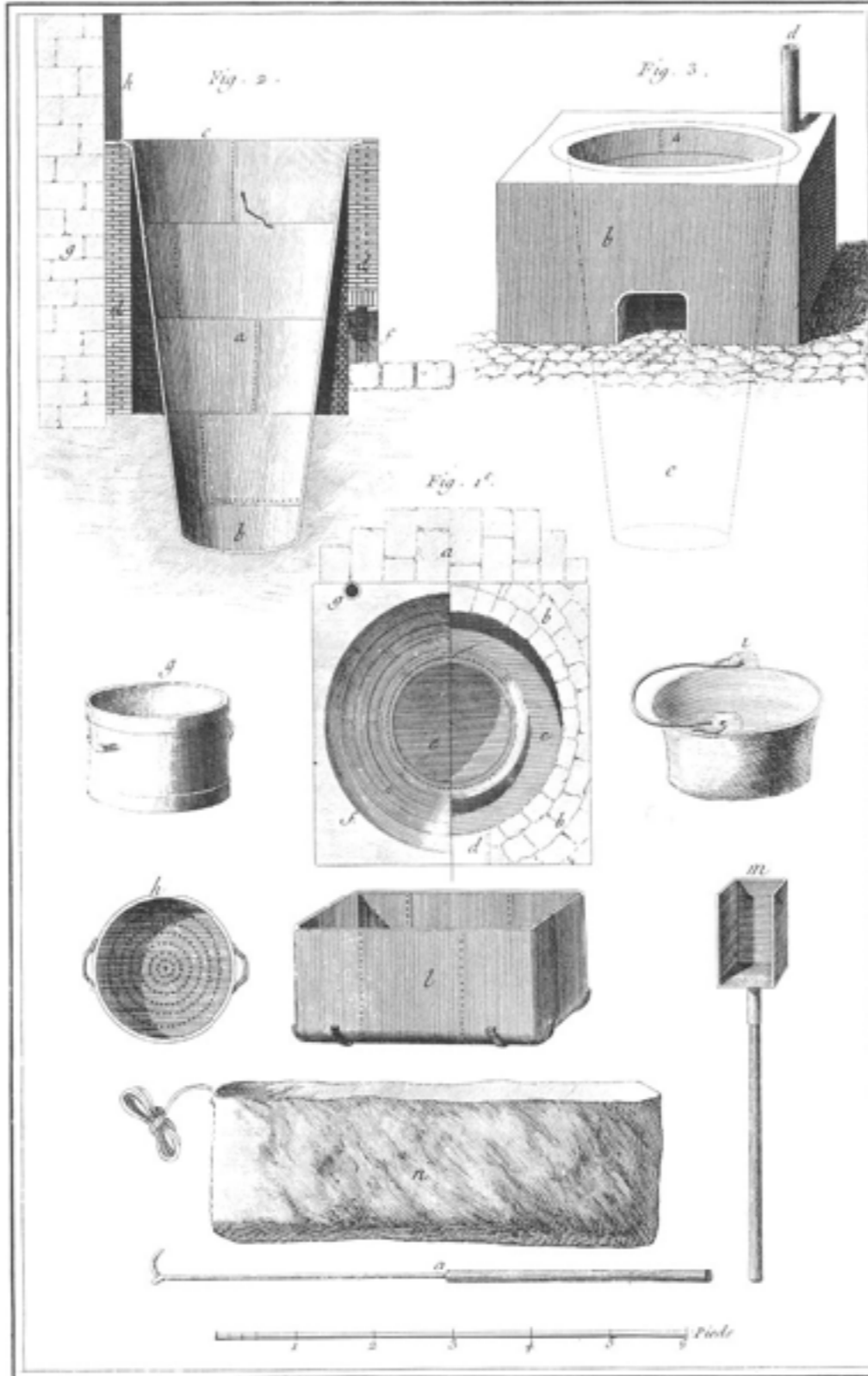

*Teinturier de Riviere, Plans, Coupe et Élévation de la Cuve pour l'Indigo.*

“Teinlurier de Riviere,, ...”  
 The Encyclopedia of Diderot & d'Alembert 1763  
 (University of Michigan)

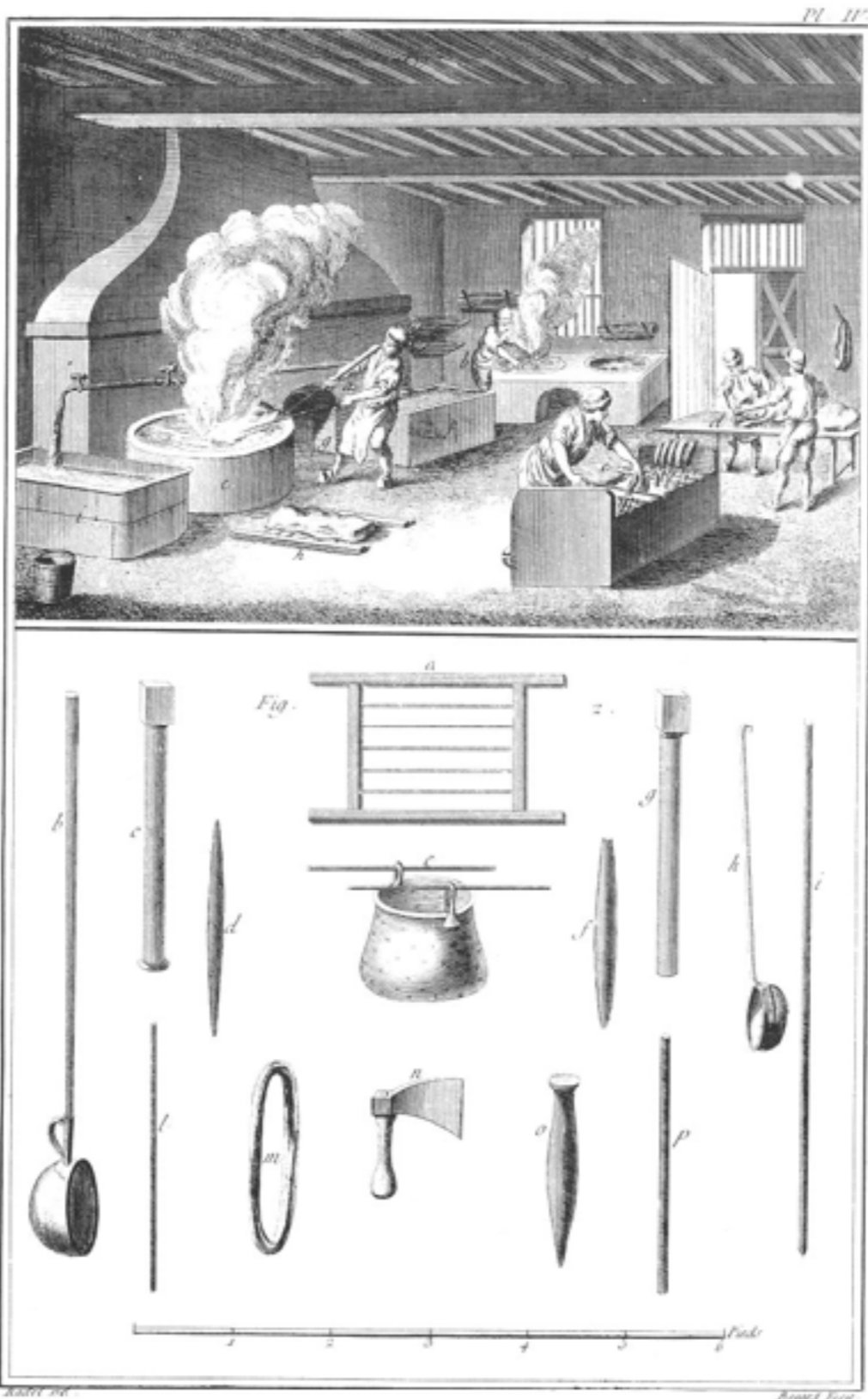

*Teinturier, atelier et Outils.*

“Teinlurier de Riviere,, ...”  
 The Encyclopedia of Diderot & d'Alembert 1763  
 (University of Michigan)

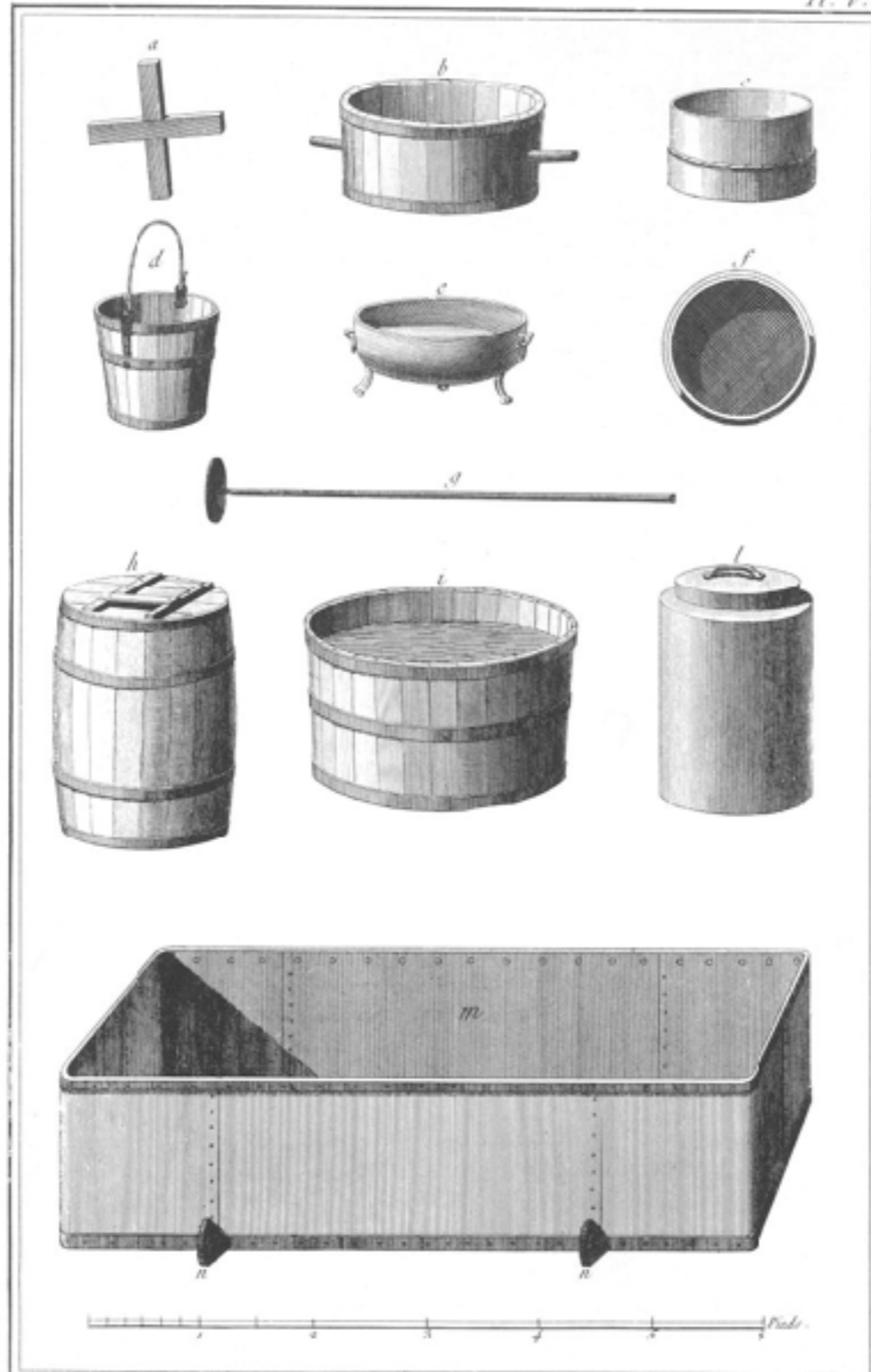

*Teinturier en Soie, Différens Votenciles pour la Teinture en Soie.*

“Teinlurier de Riviere,, ...”  
 The Encyclopedia of Diderot & d'Alembert 1763  
 (University of Michigan)

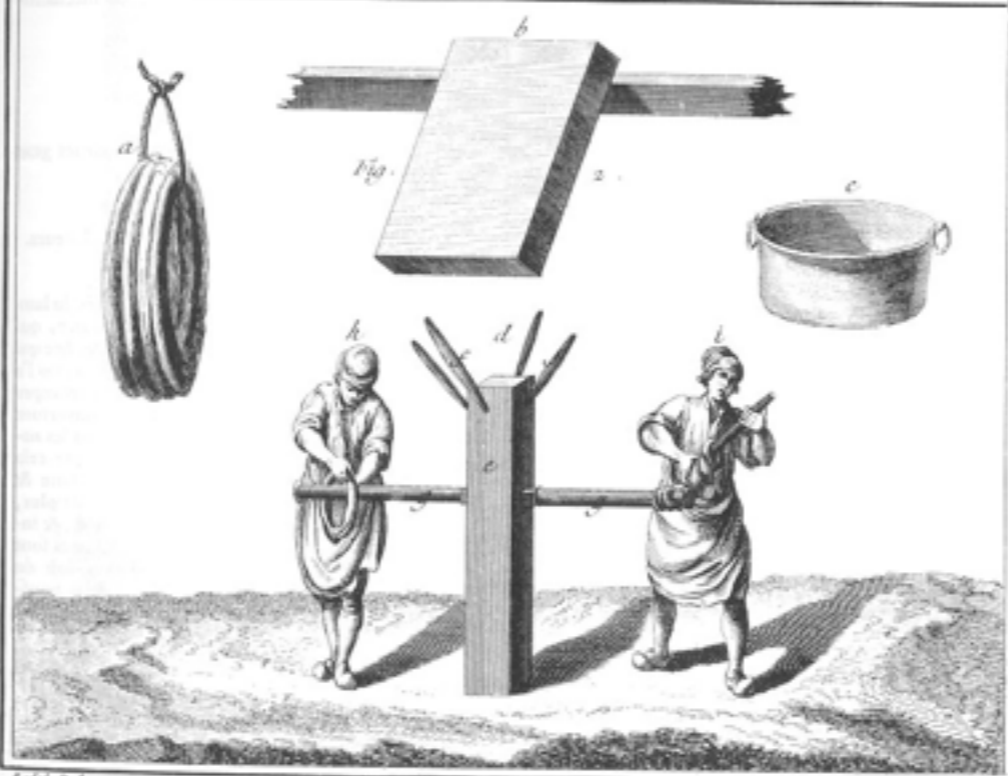
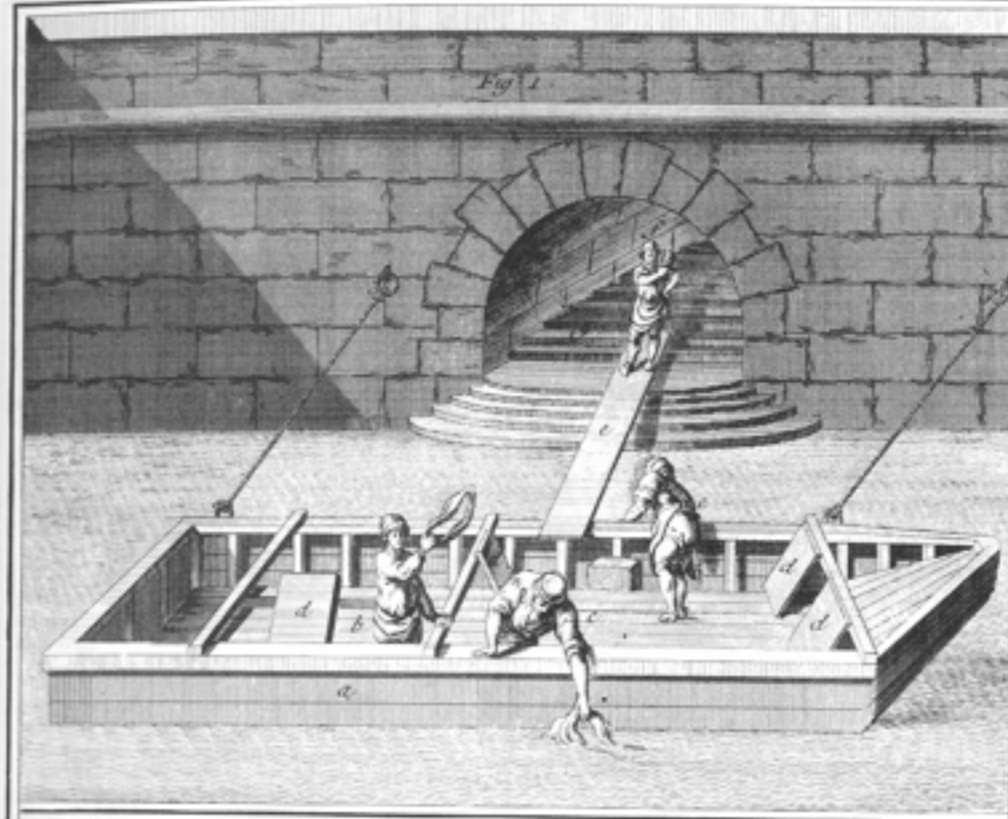

*Teinturier, Lavage des soies à la Rivière et Service de l'Espart.*

“Teinlurier de Riviere,, ...”  
 The Encyclopedia of Diderot & d'Alembert 1763  
 (University of Michigan)

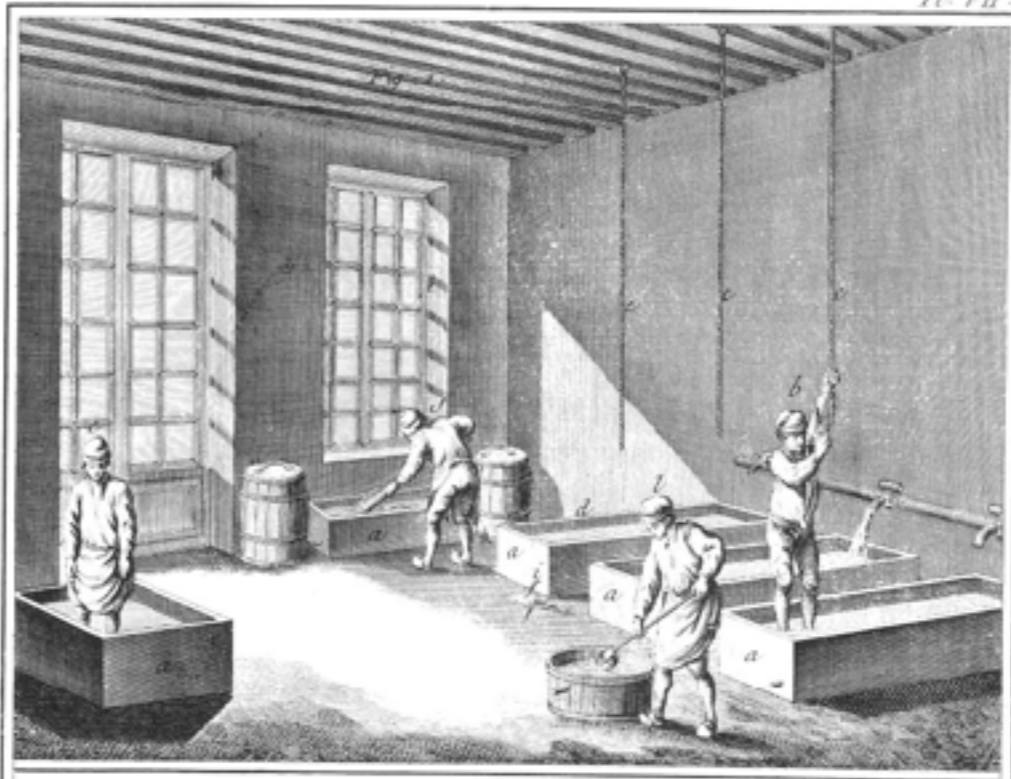

Echelle de la Figure 2.

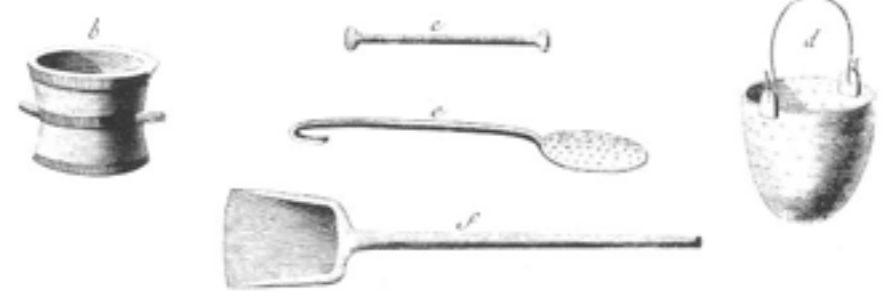
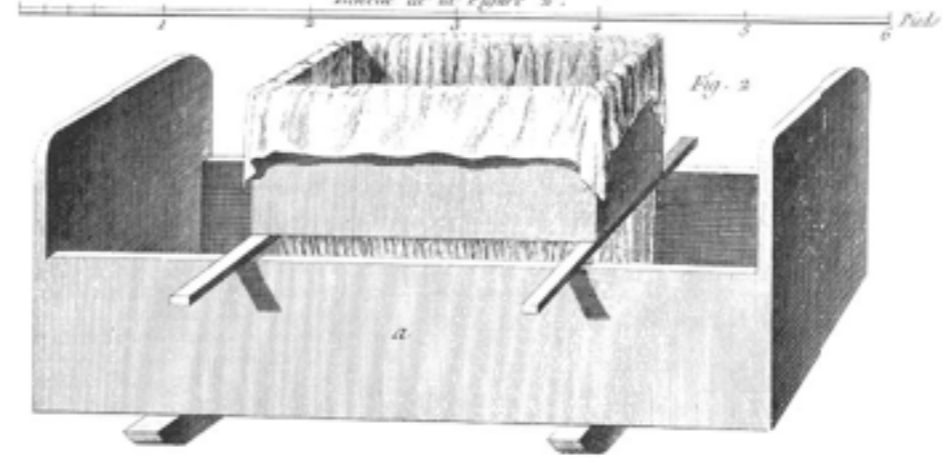

*Teinturier, différentes préparations du Safranum et Outils.*

“Teinlurier de Riviere,, ...”  
 The Encyclopedia of Diderot & d'Alembert 1763  
 (University of Michigan)

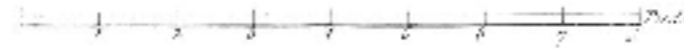
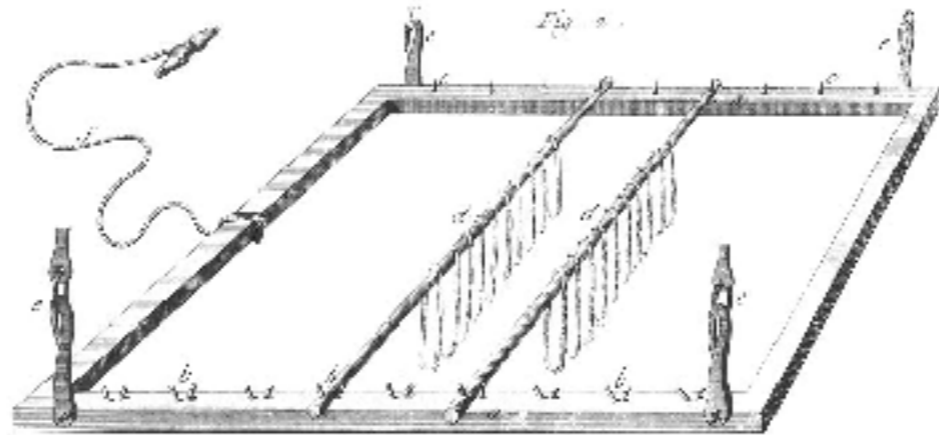
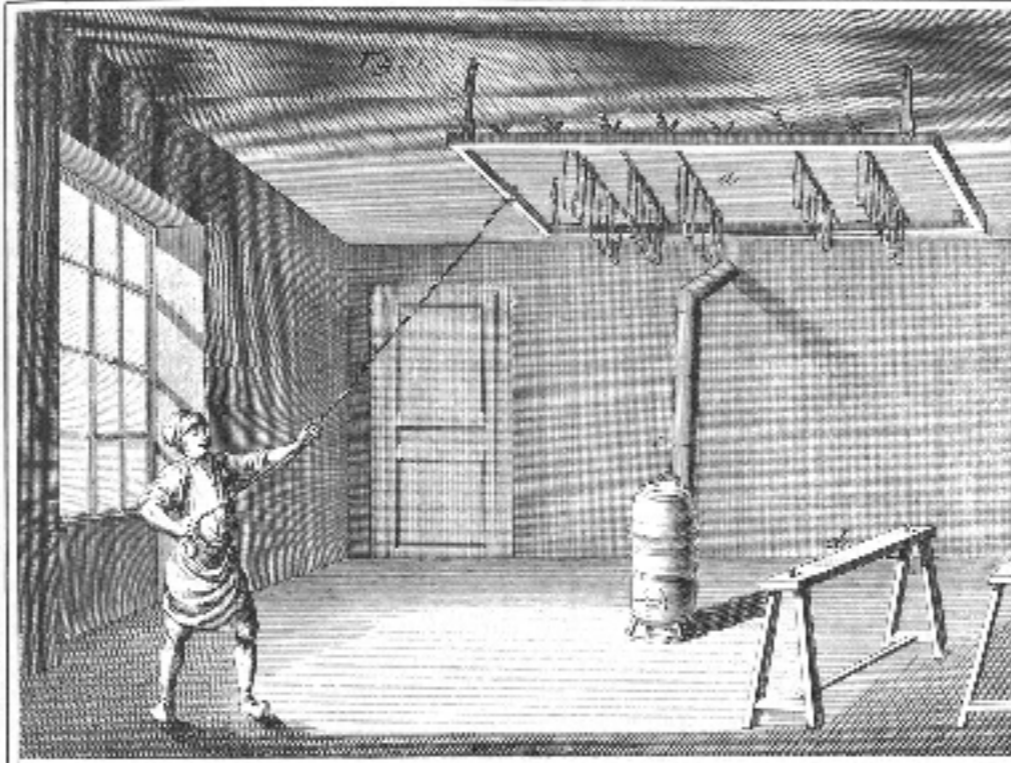

Gravé par M. de la Harpe.

Benard del.

*Teinturier, le Séchoir pour les Soies &c.*

“Teinturier de Riviere,, ...”  
 The Encyclopedia of Diderot & d’Alembert 1763  
 (University of Michigan)

# Trimming Production

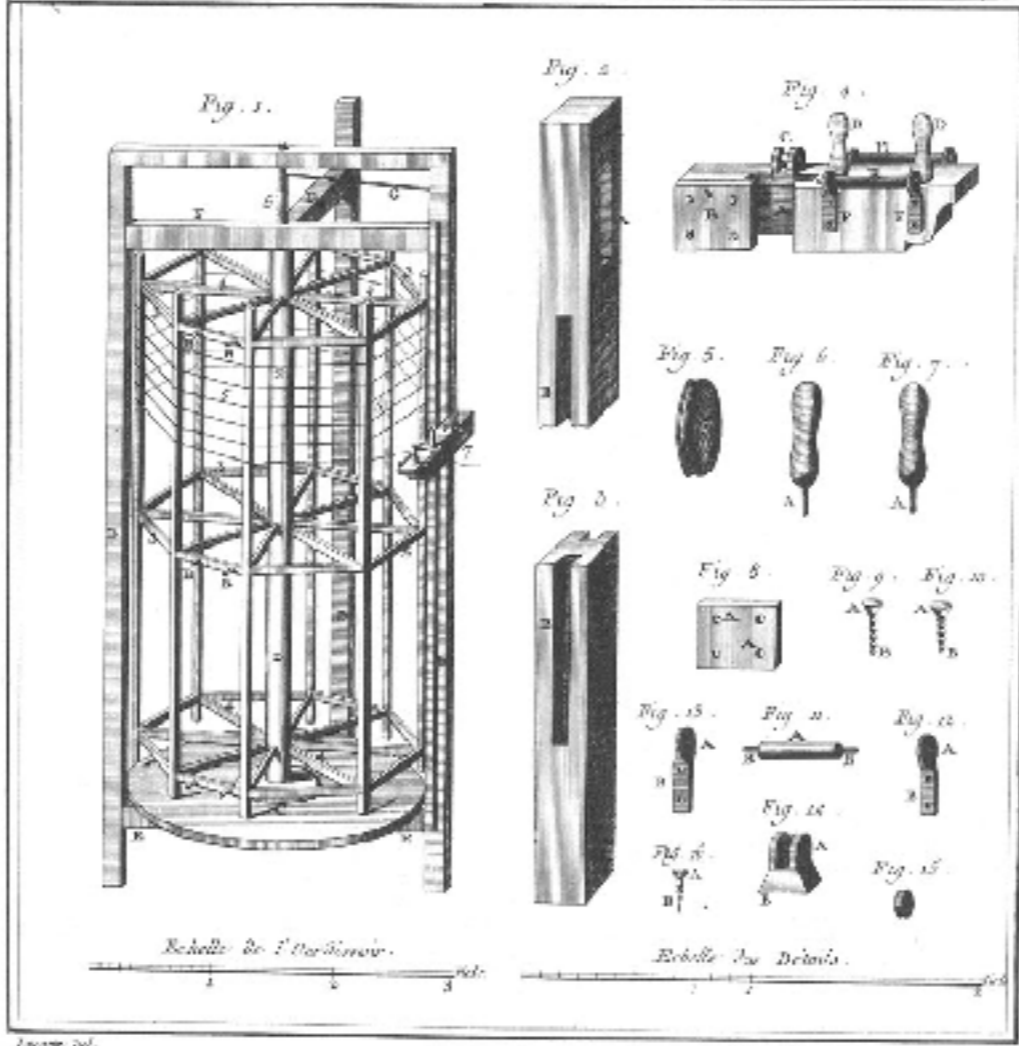
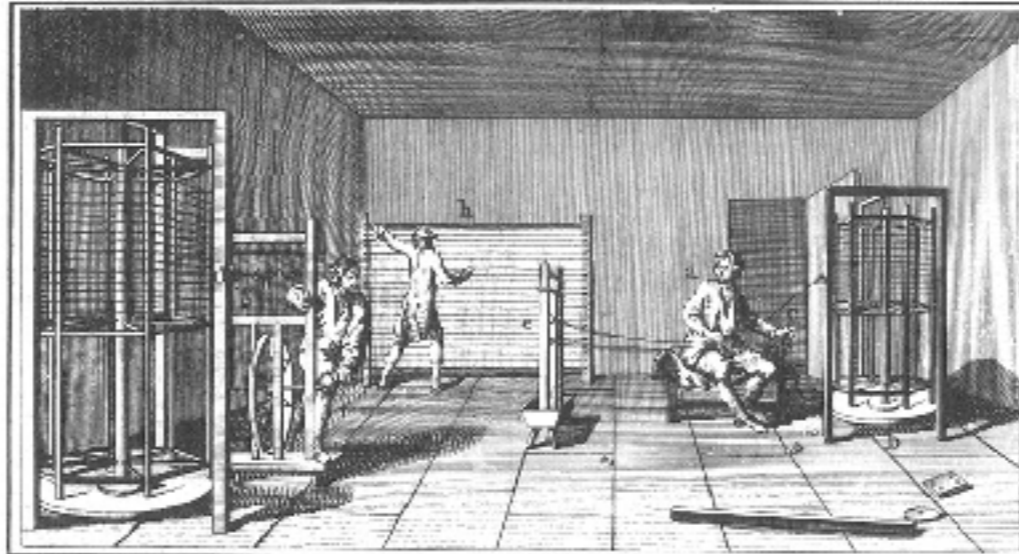

*Passenterie, ourdissoir.*

“Passenterie, ...”  
 The Encyclopedia of Diderot & d'Alembert 1763  
 (University of Michigan)

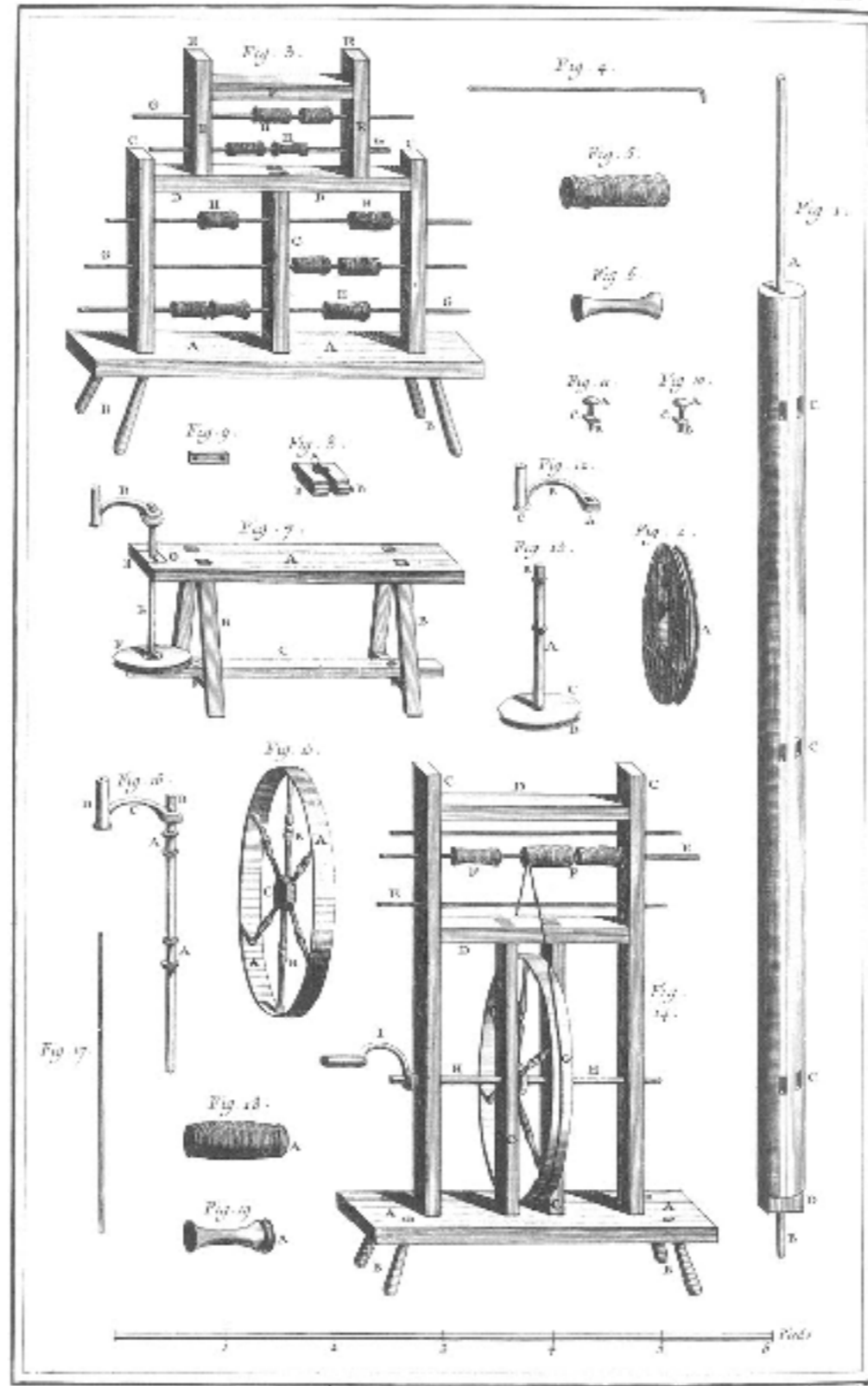

*Passementerie, Ourdissoir, Banque d. Rouet.*

“Passementerie, ...”

The Encyclopedia of Diderot & d'Alembert 1763  
(University of Michigan)

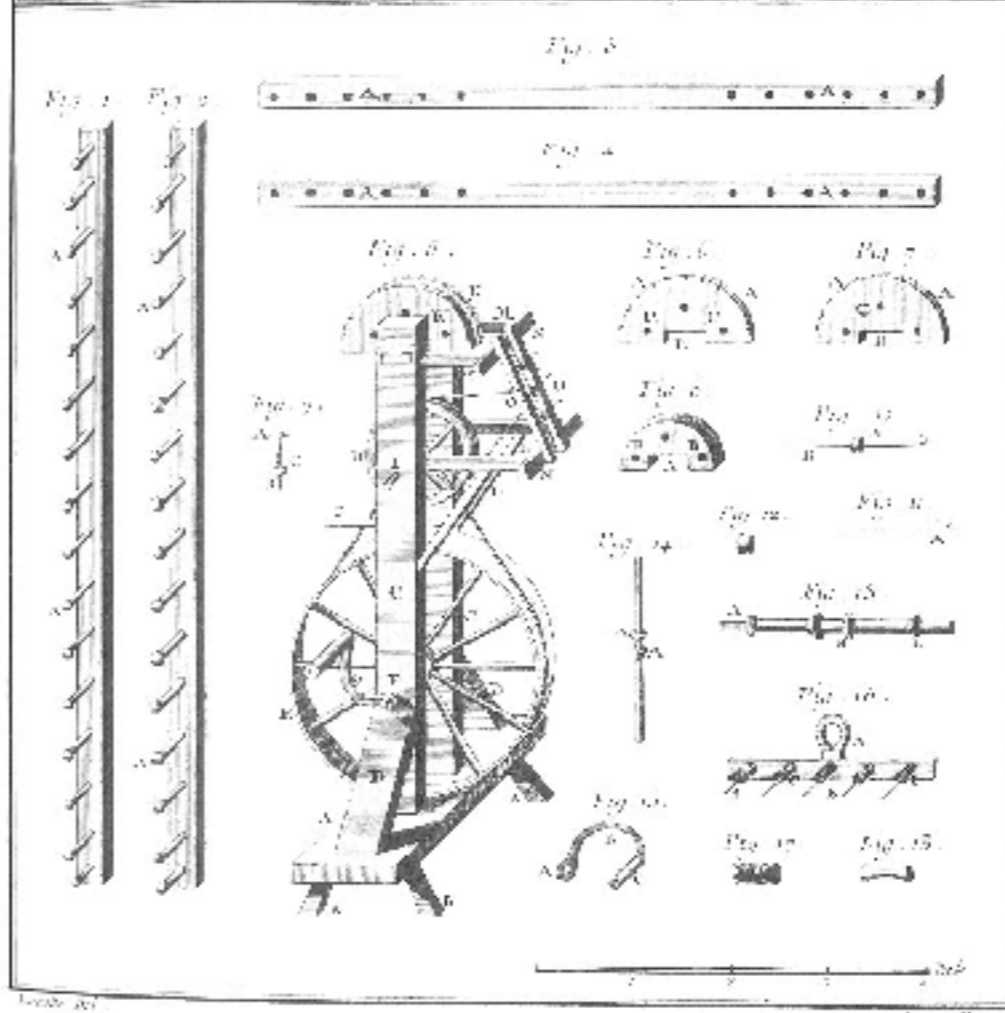
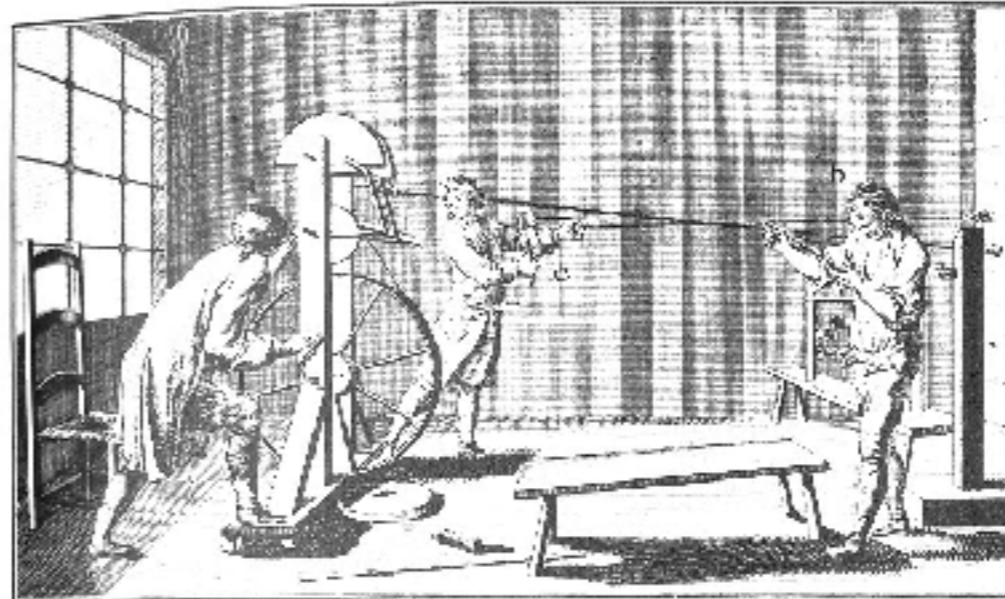

*Passementerie, Rovers*

“Passementerie, ...”  
 The Encyclopedia of Diderot & d'Alembert 1763  
 (University of Michigan)

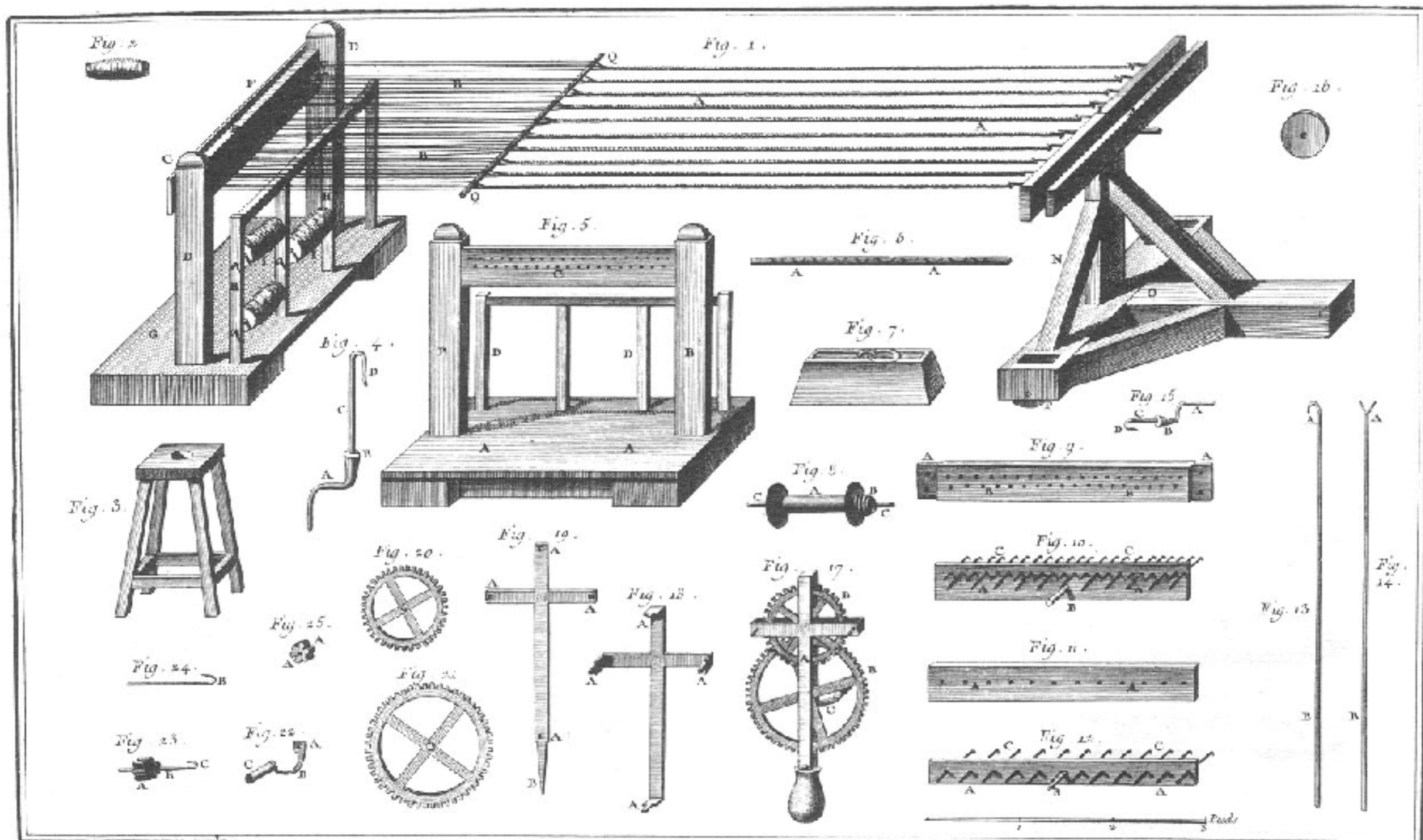

*Passementerie, Retors.*

“Passementerie, ...”  
 The Encyclopedia of Diderot & d’Alembert 1763  
 (University of Michigan)

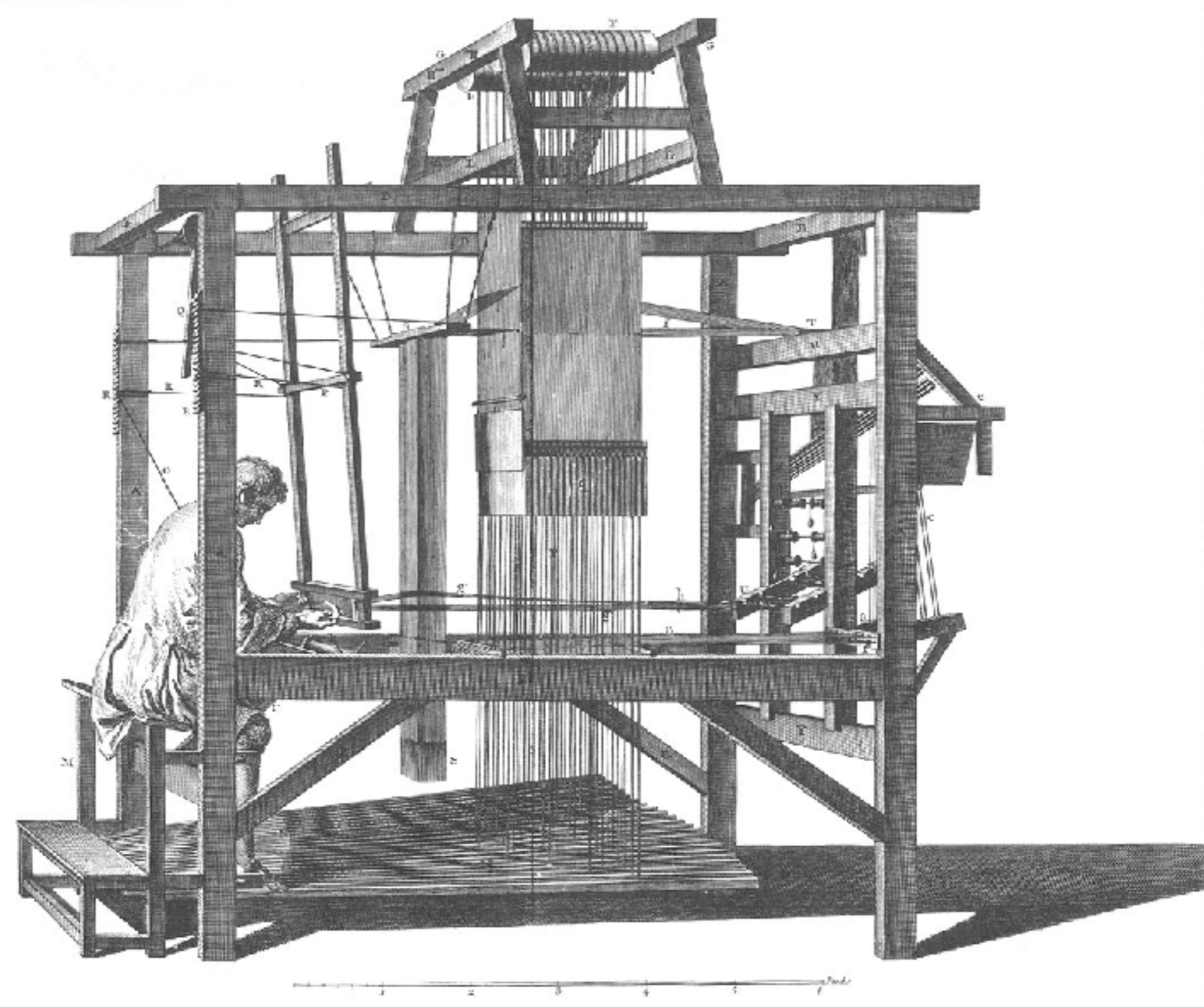

Leveillé del.

Bonard fecit.

*Passementerie, Mètier à faire le Galon, ? .*

“Passementerie, ...”  
 The Encyclopedia of Diderot & d'Alembert 1763  
 (University of Michigan)

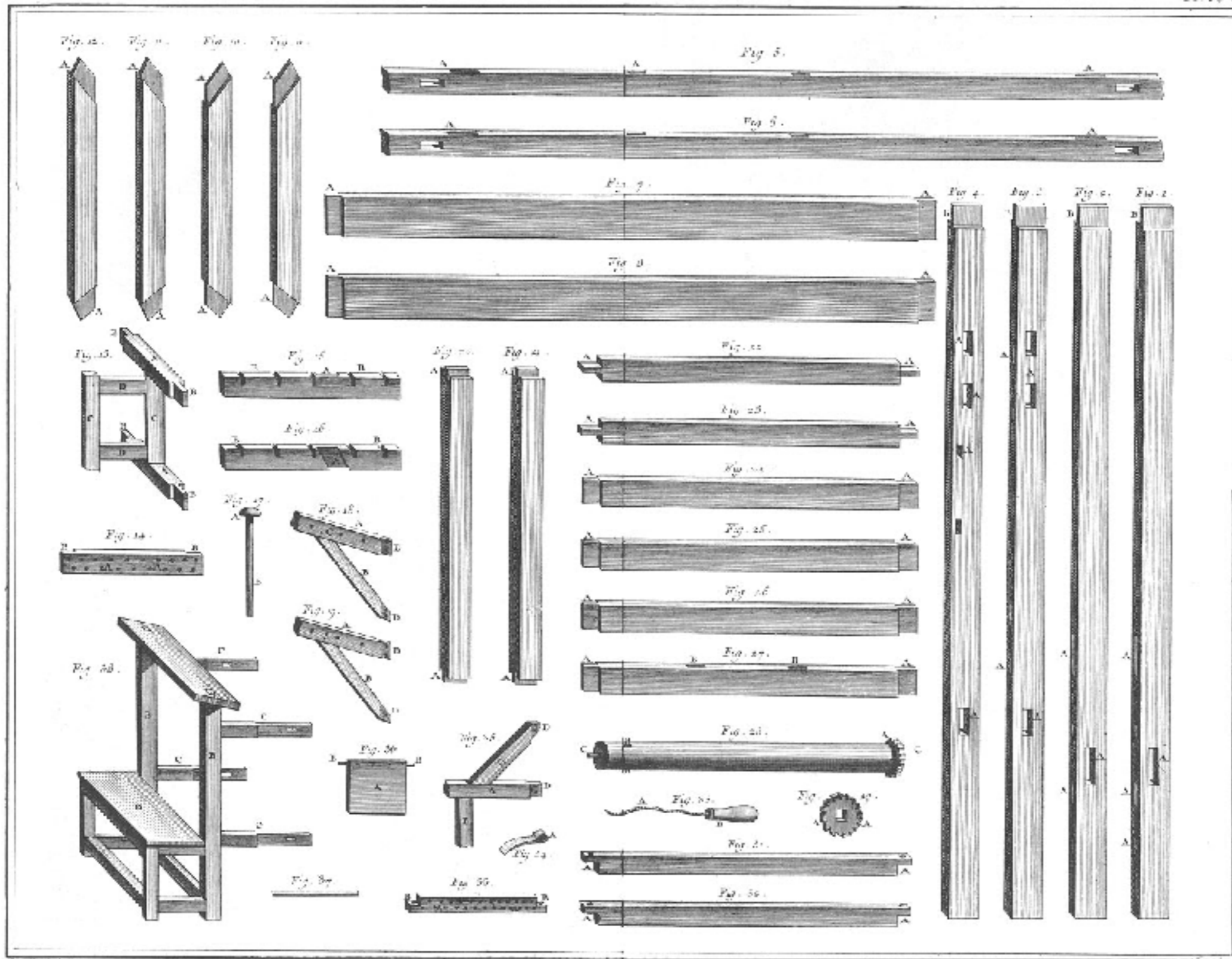

*Passenterie, détail de Meuble à faire le Galon.*

“Passenterie, ...”

The Encyclopedia of Diderot & d'Alembert 1763  
(University of Michigan)

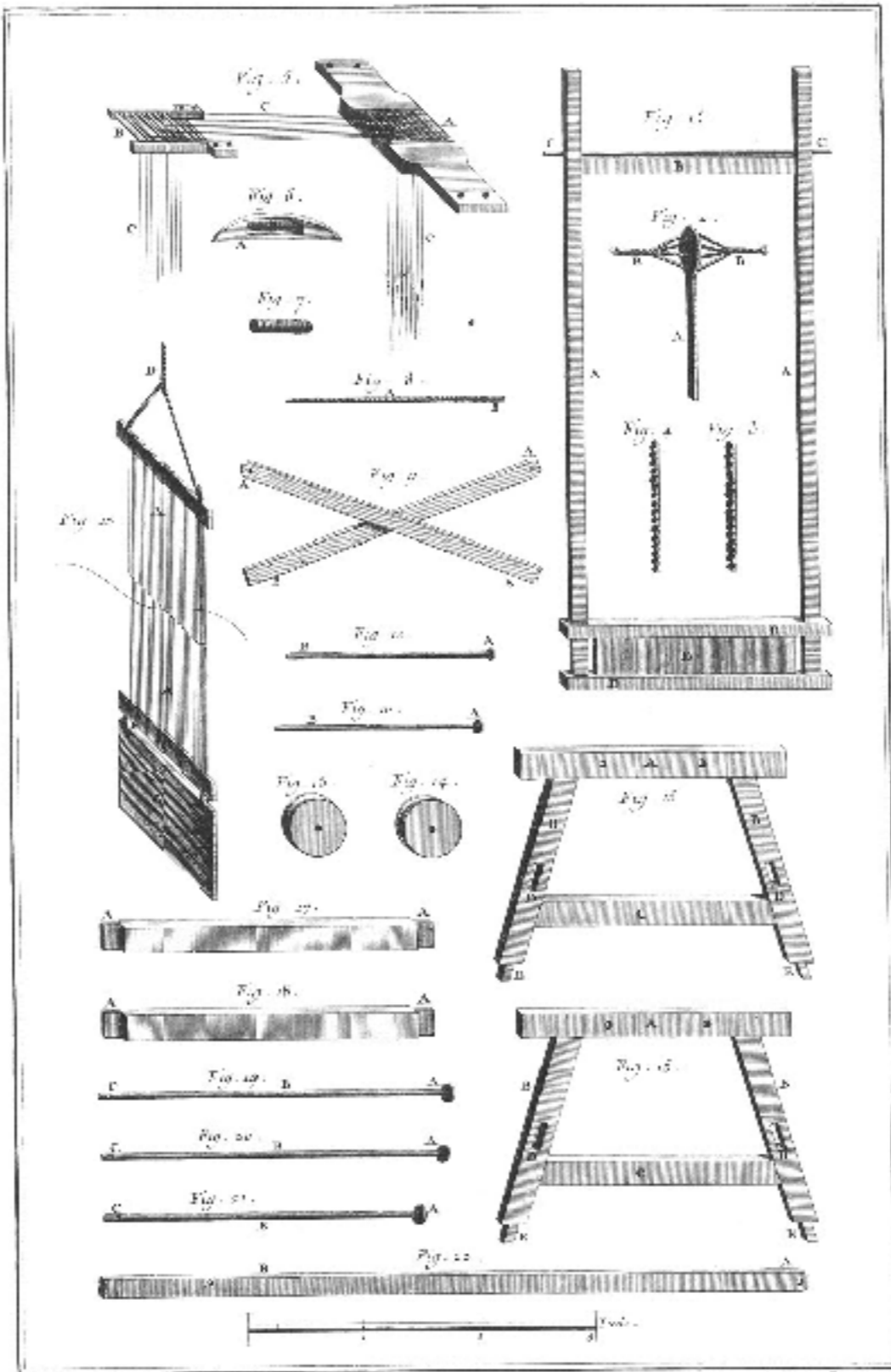

Lecrue del.

Beccat sculp.

*Passementerie, détail du Mètre à Galon*

“Passementerie, ...”

The Encyclopedia of Diderot & d'Alembert 1763  
(University of Michigan)

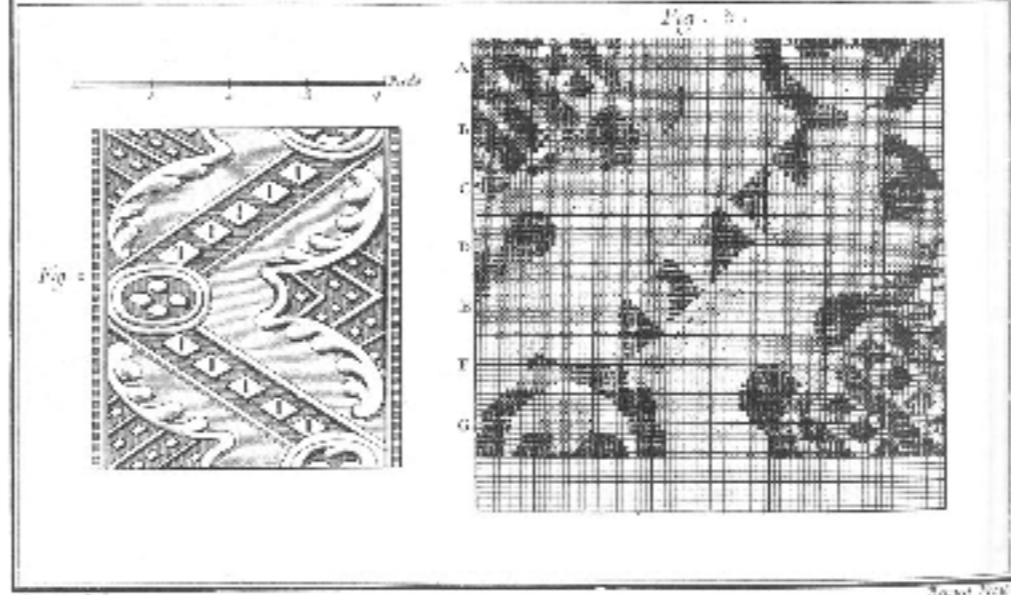
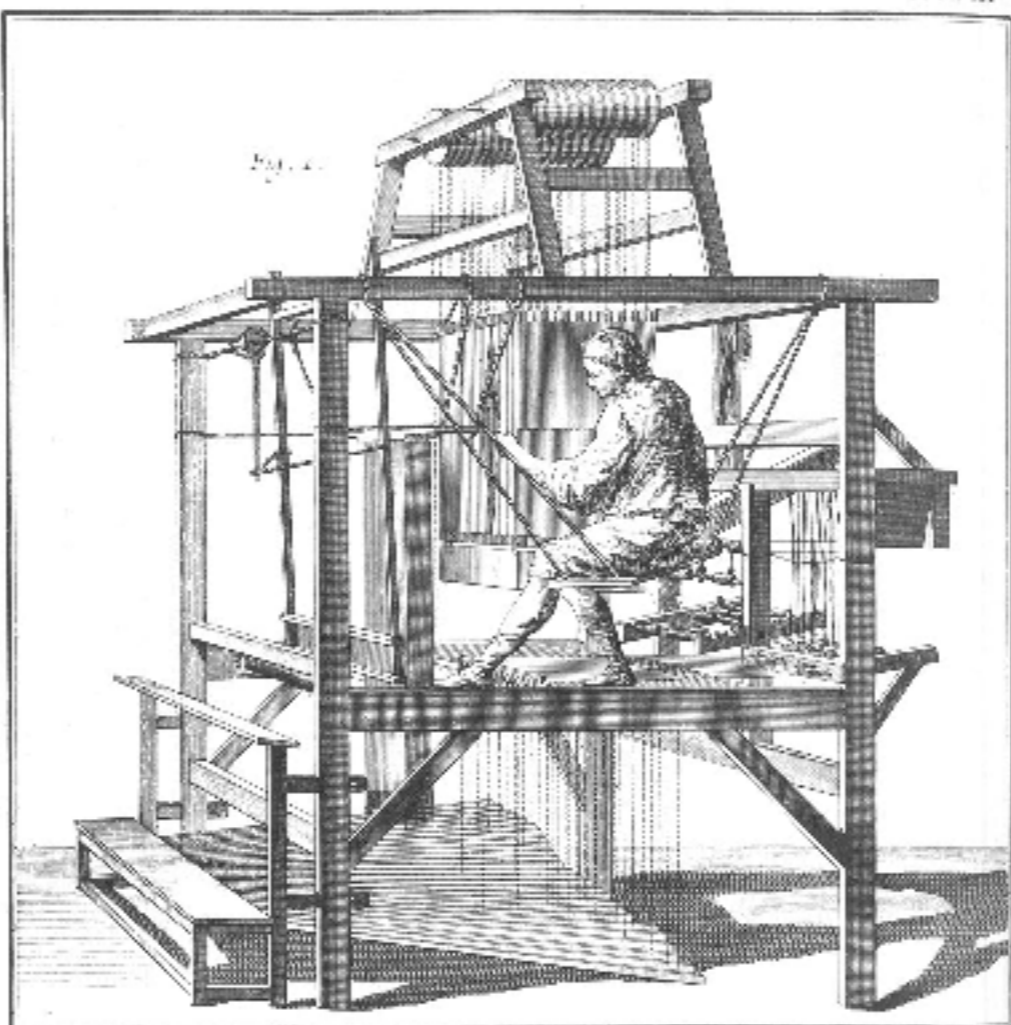

Lezard 200.      Robert 200

*Passementerie, Façon de passer le Patron par Decout.*

“Passementerie, ...”  
 The Encyclopedia of Diderot & d'Alembert 1763  
 (University of Michigan)

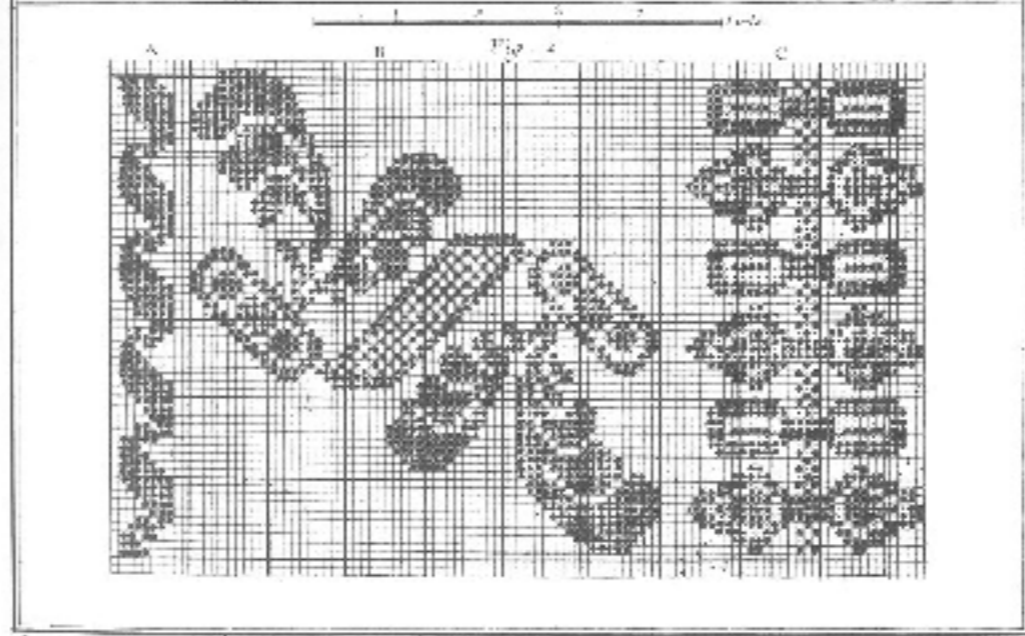
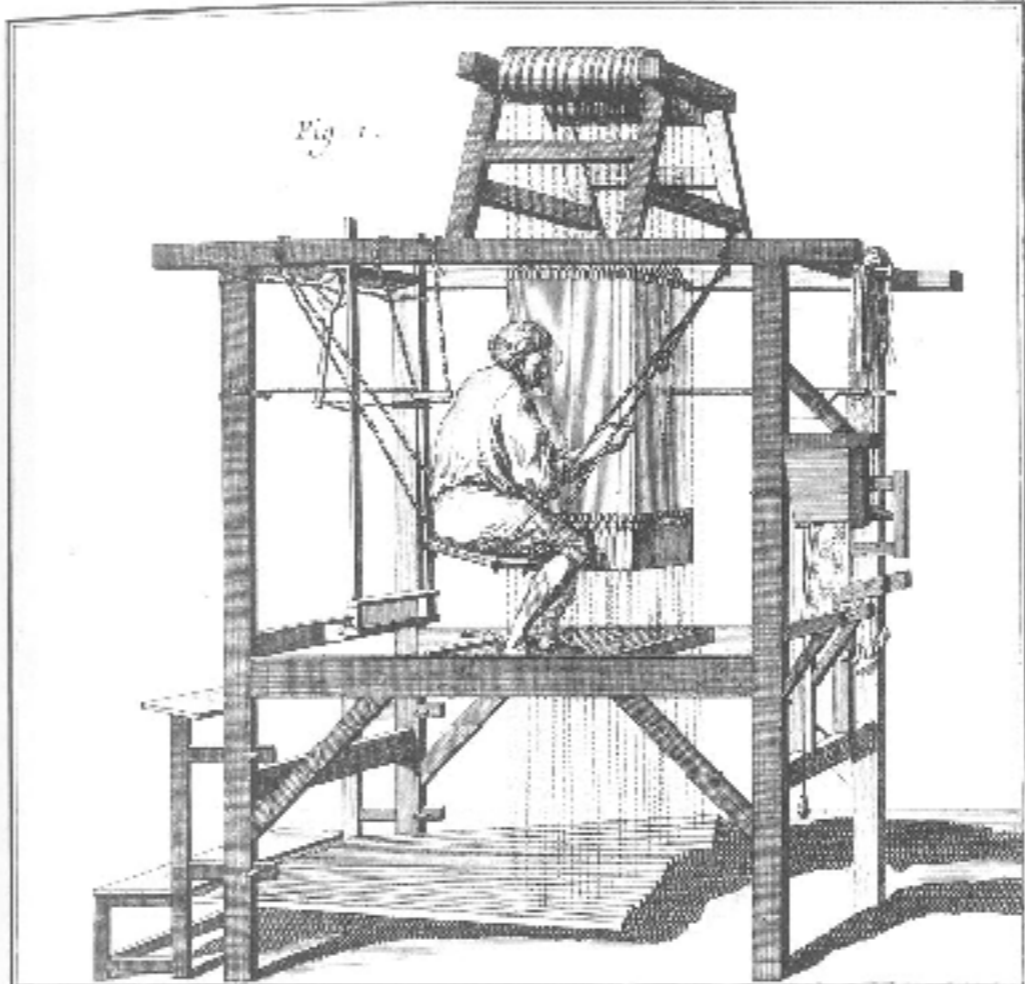

La Motte del. P. de la Haye sculp.

*Passementerie, Façon de passer le Patron par derrière*

“Passementerie, ...”  
 The Encyclopedia of Diderot & d'Alembert 1763  
 (University of Michigan)

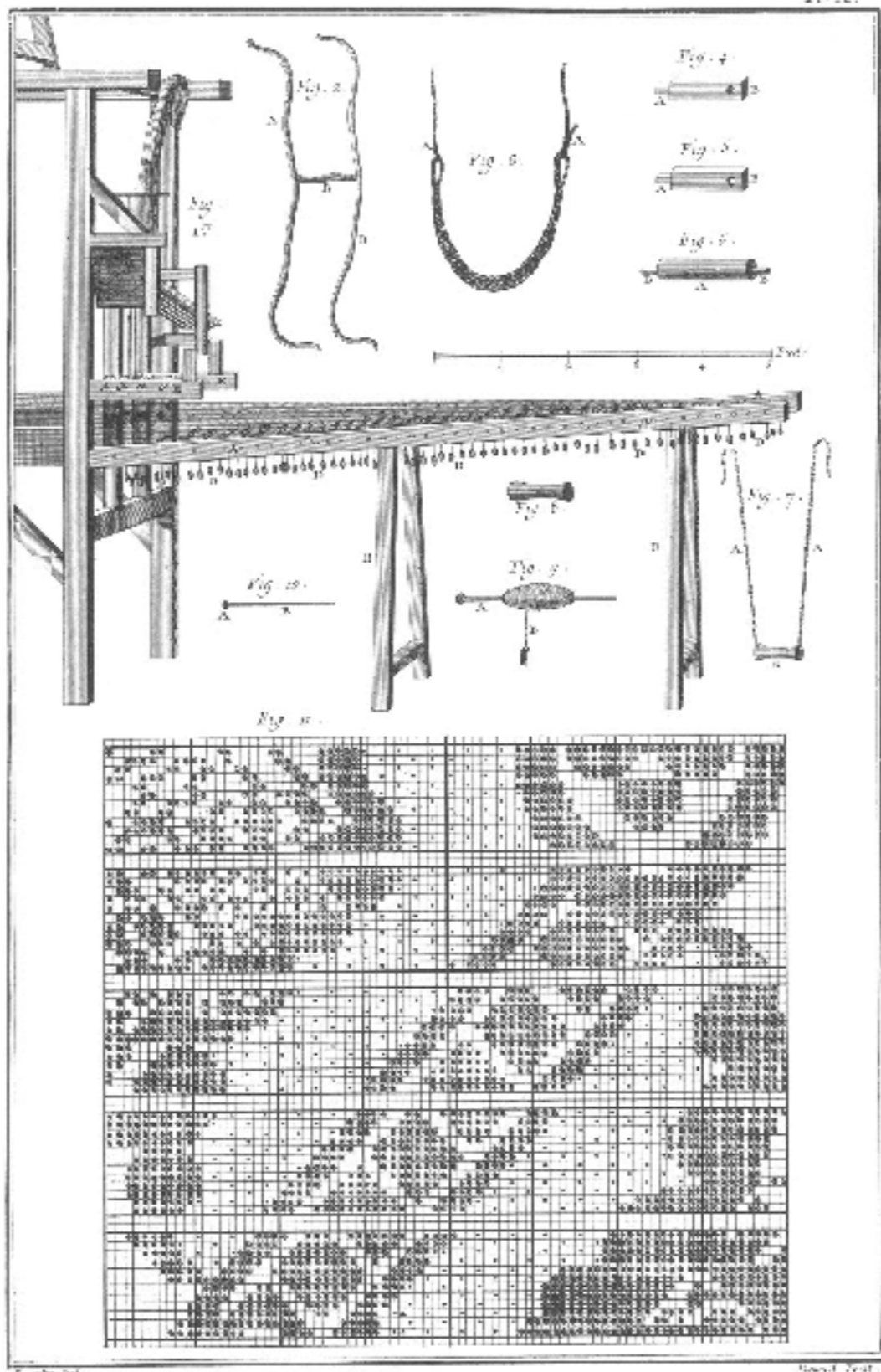

*Passementerie, Mâtier et Laminé et Patron.*

“Passementerie, ...”  
 The Encyclopedia of Diderot & d'Alembert 1763  
 (University of Michigan)

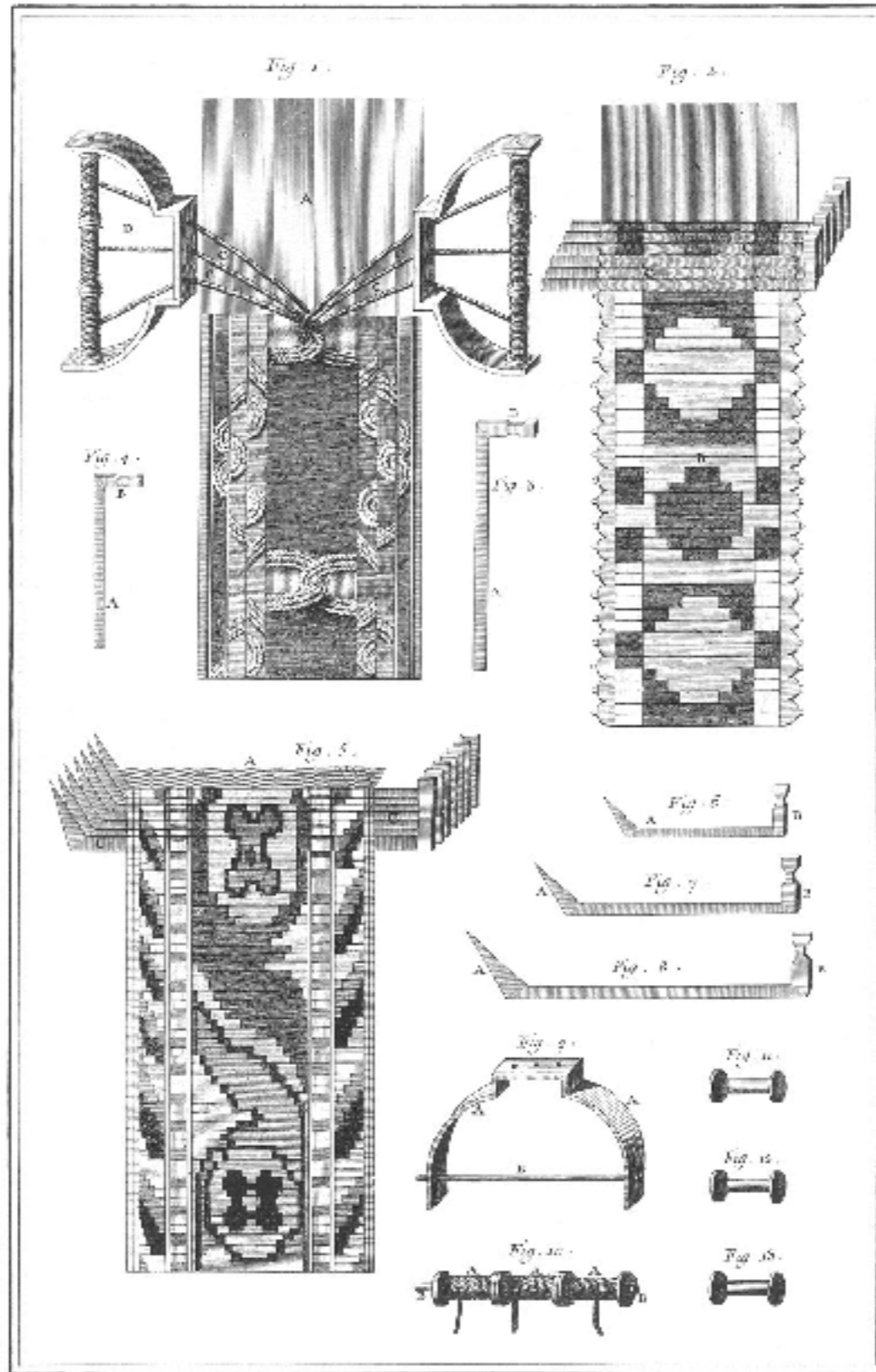

Lezelle Del.

Beard Insc.

*Passenterie, noueurs de Galons.*

“Passenterie, ...”  
 The Encyclopedia of Diderot & d'Alembert 1763  
 (University of Michigan)

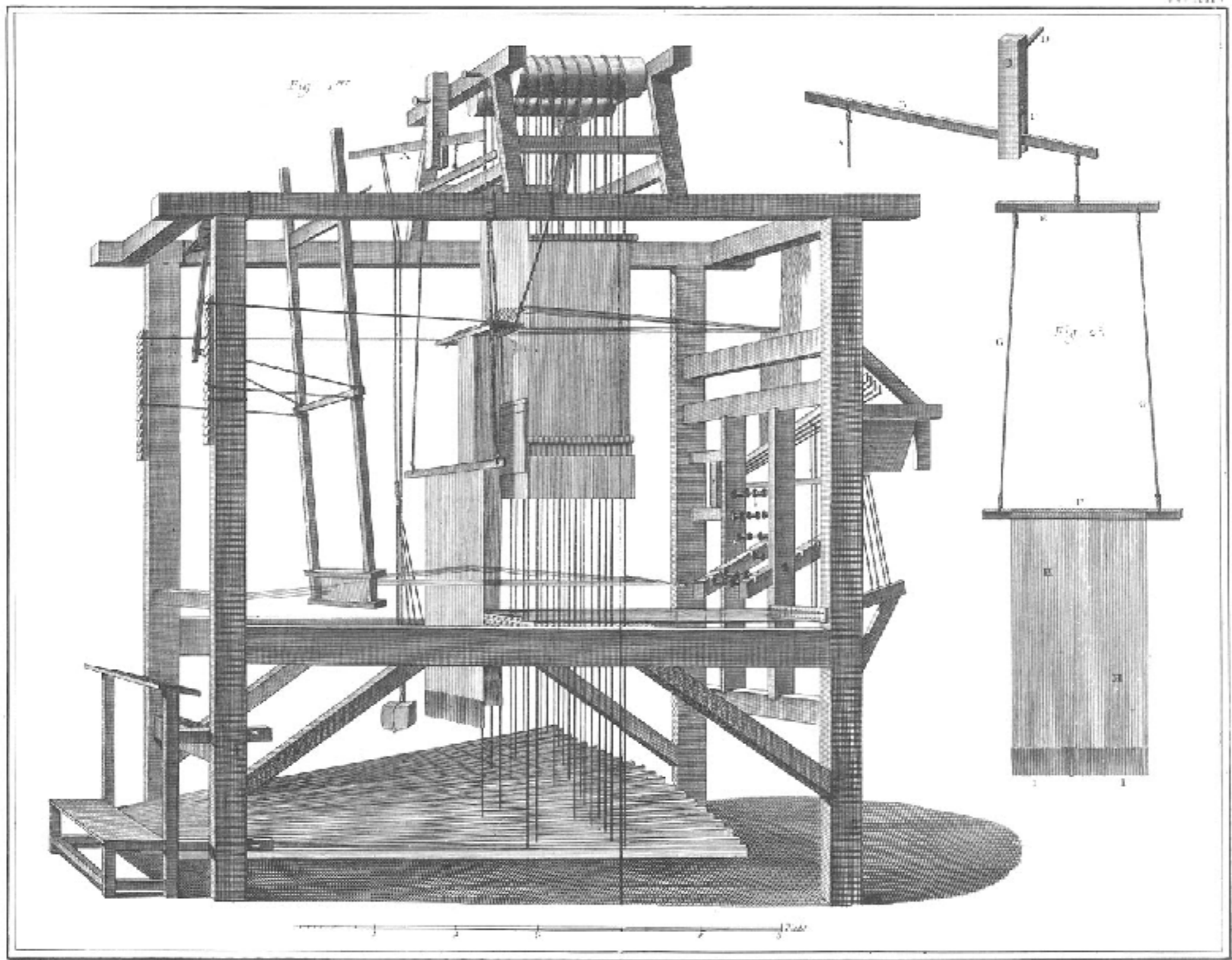

*Passementerie, Matic du Ruban figure.*

“Passementerie, ...”  
 The Encyclopedia of Diderot & d'Alembert 1763  
 (University of Michigan)

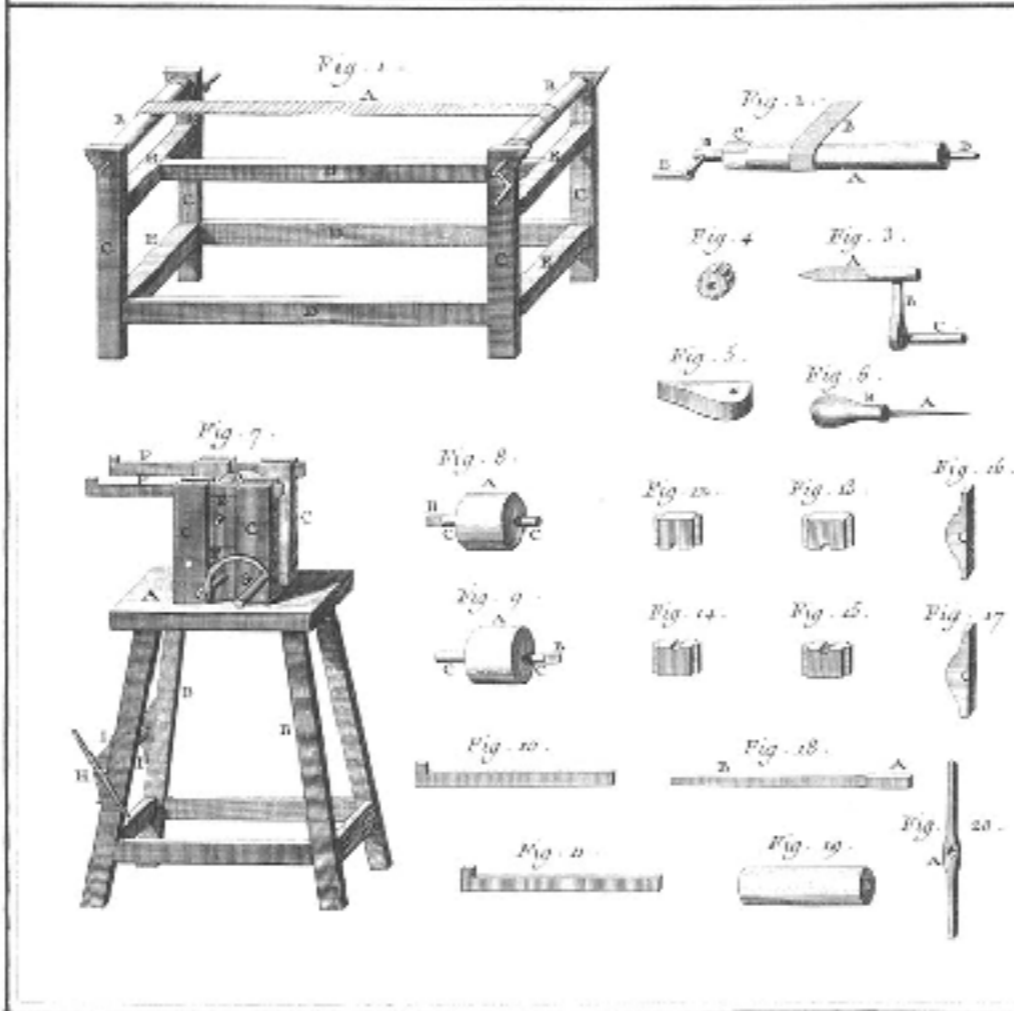
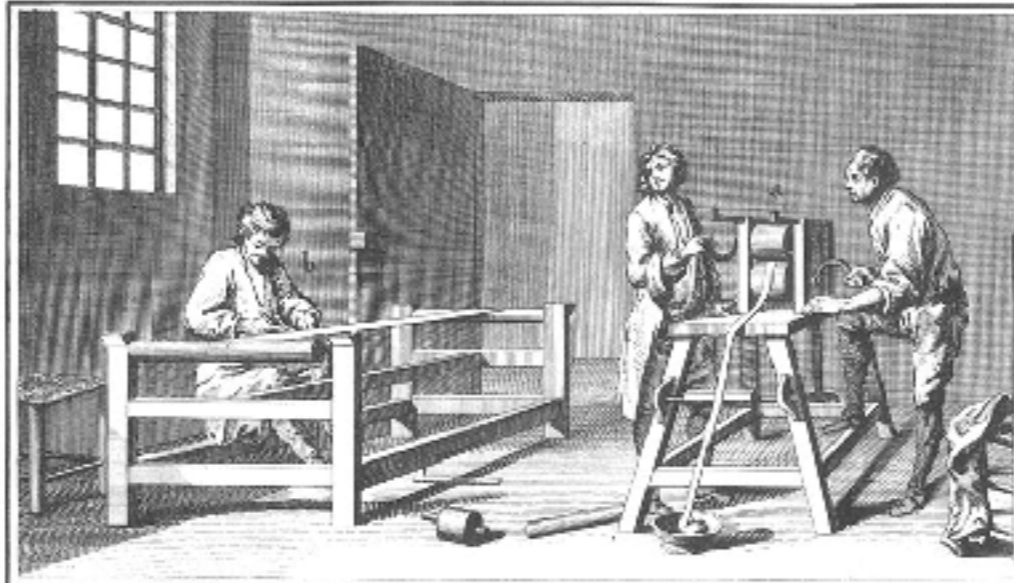

Lacelle Del.

Bourd'Est

*Passenterie, Montage et Passage du Ruban ou Galon.*

“Passenterie, ...”  
 The Encyclopedia of Diderot & d'Alembert 1763  
 (University of Michigan)

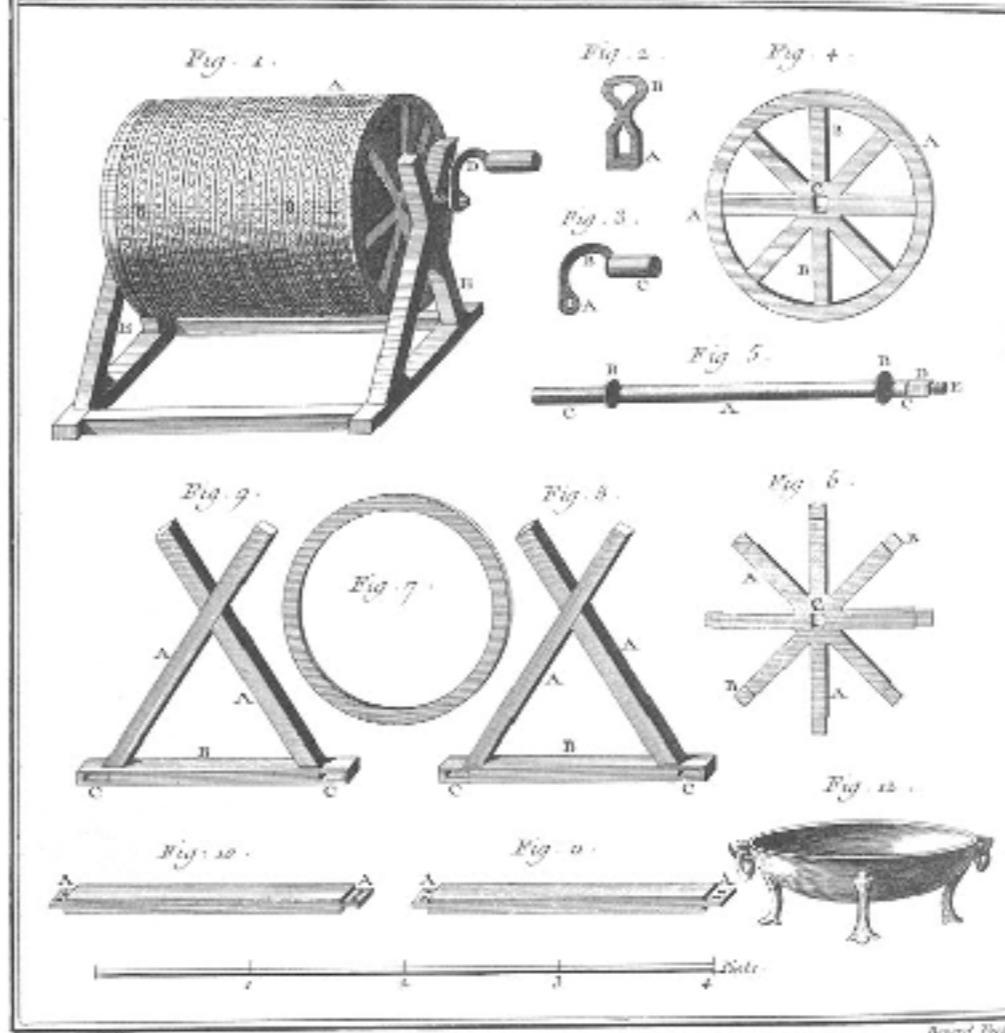

*Passenterie, Fumage du Galon ?*

“Passenterie, ...”  
 The Encyclopedia of Diderot & d'Alembert 1763  
 (University of Michigan)

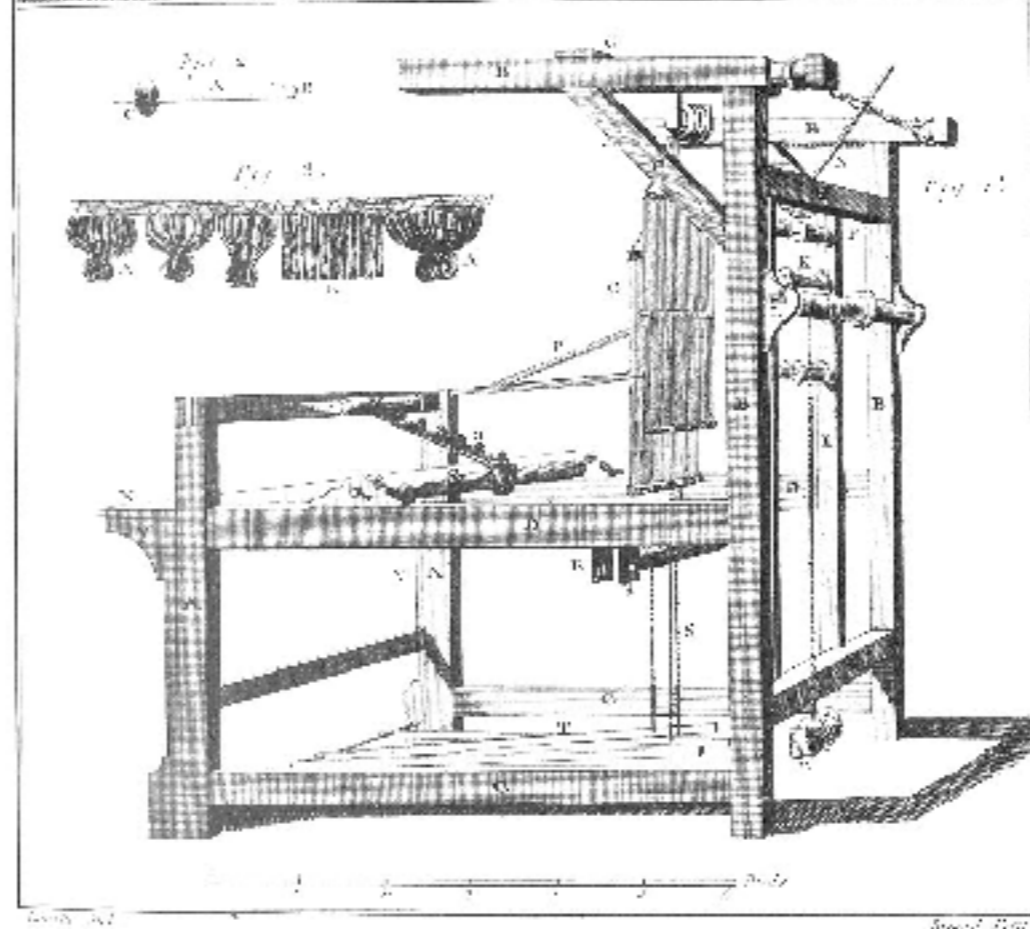
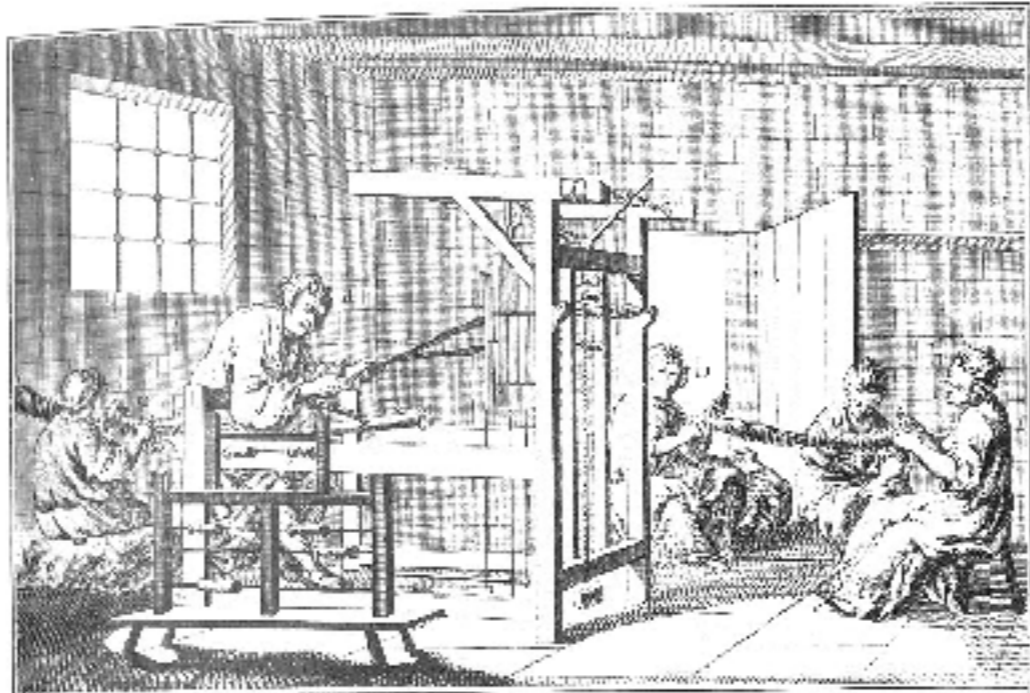

*Passementerie, Machine à Passer.*

“Passementerie, ...”  
The Encyclopedia of Diderot & d'Alembert 1763  
(University of Michigan)

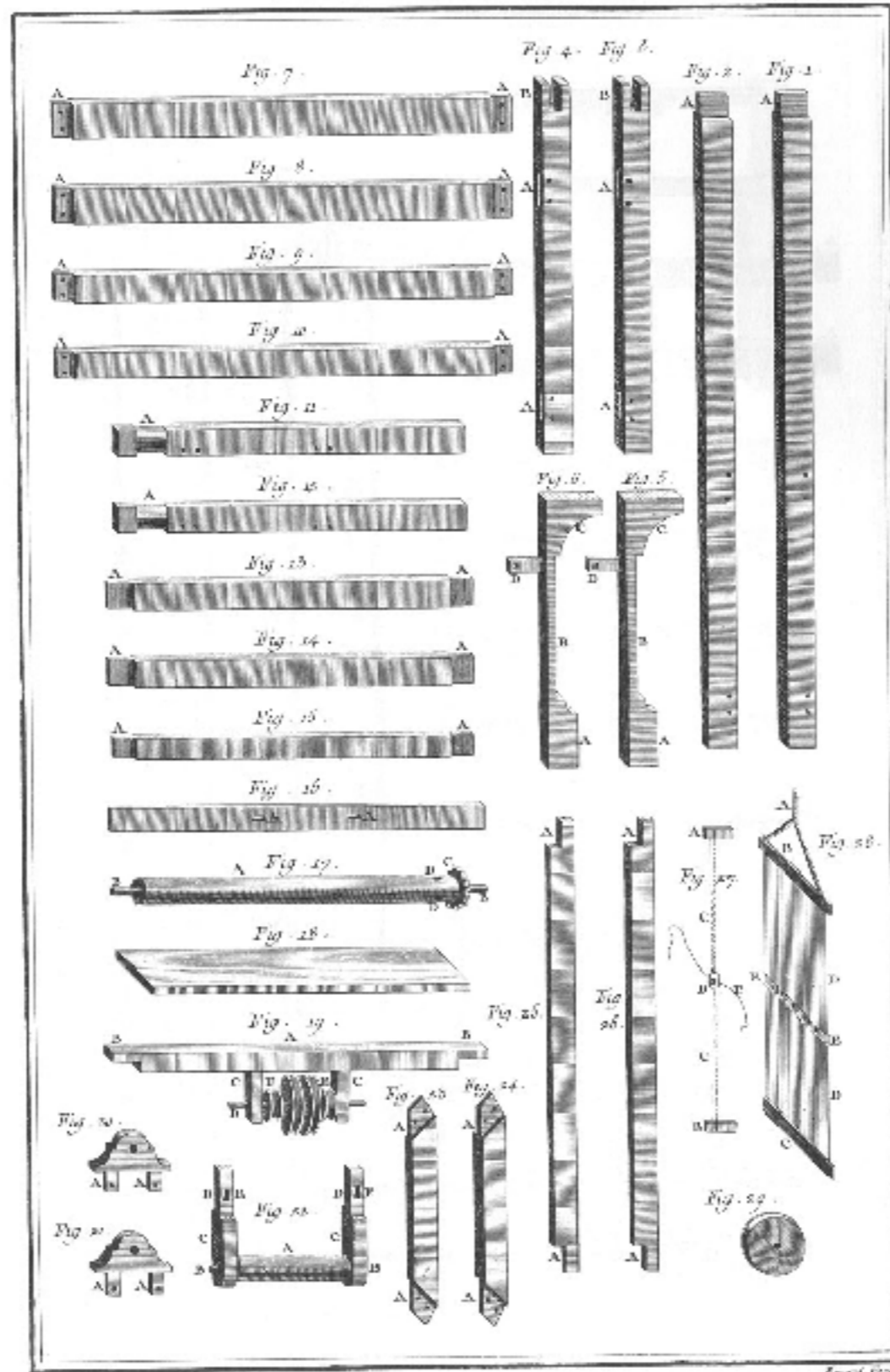

Lanille del.

Benard fecit.

*Passementerie, détail du Meier a Frapper.*

“Passementerie, ...”  
 The Encyclopedia of Diderot & d'Alembert 1763  
 (University of Michigan)

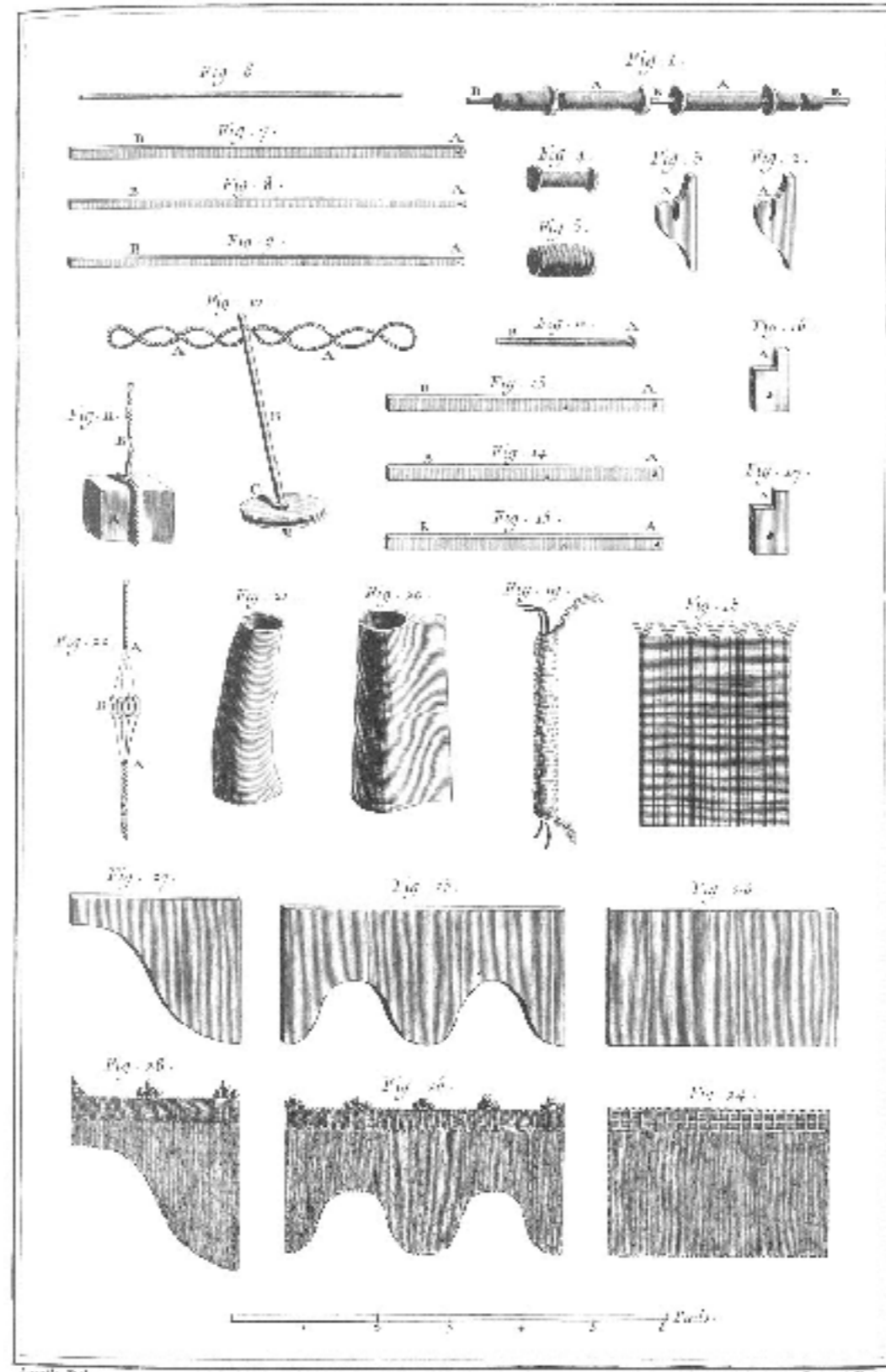

L'œuvre de l'Art.

Encre de Peau.

*Passementerie, détail du Menuisier à Froger.*

“Passementerie, ...”

The Encyclopedia of Diderot & d'Alembert 1763  
(University of Michigan)

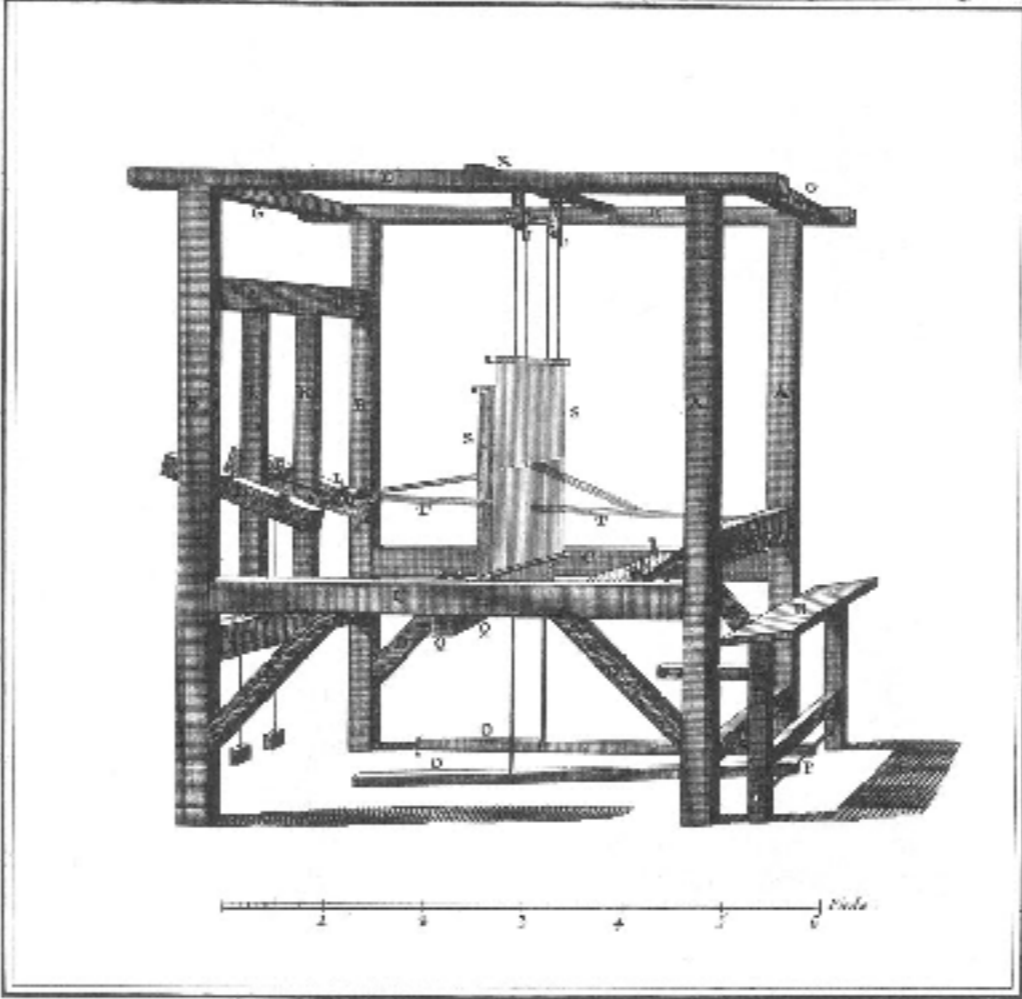
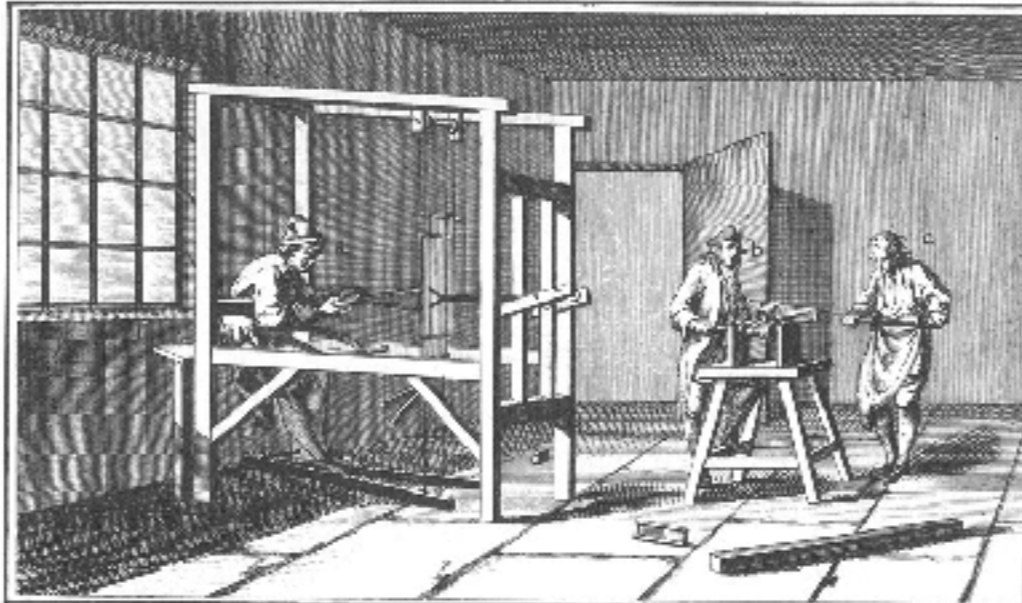

Lucotte del.

Benard fecit.

*Passenterie, Mètier à la Basse Lisière.*

“Passenterie, ...”  
 The Encyclopedia of Diderot & d'Alembert 1763  
 (University of Michigan)

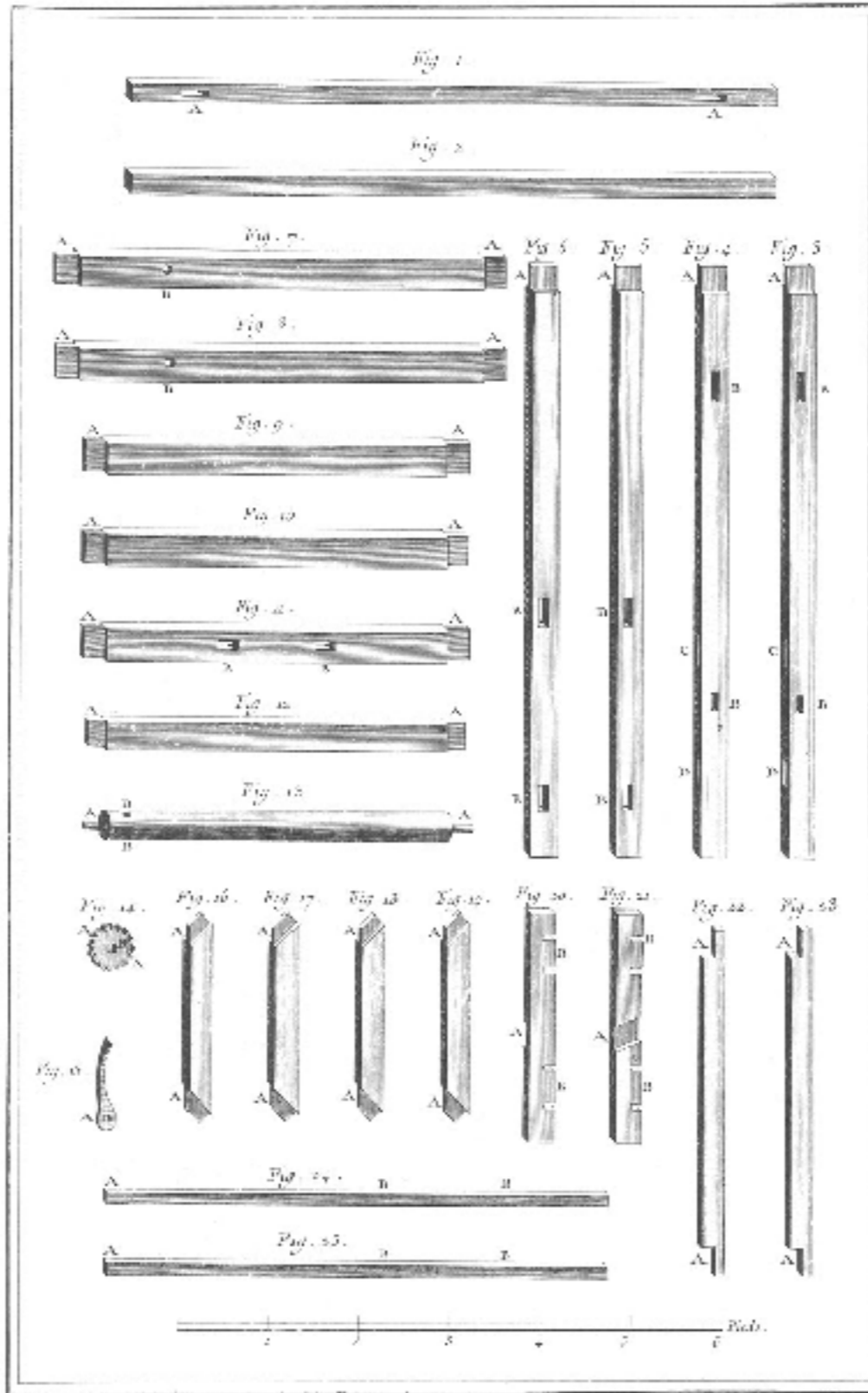

Leclerc del.

Beaumont fecit.

*Passementerie, Détails du Metier à la Basée Liffée.*

“Passementerie, ...”

The Encyclopedia of Diderot & d'Alembert 1763  
(University of Michigan)

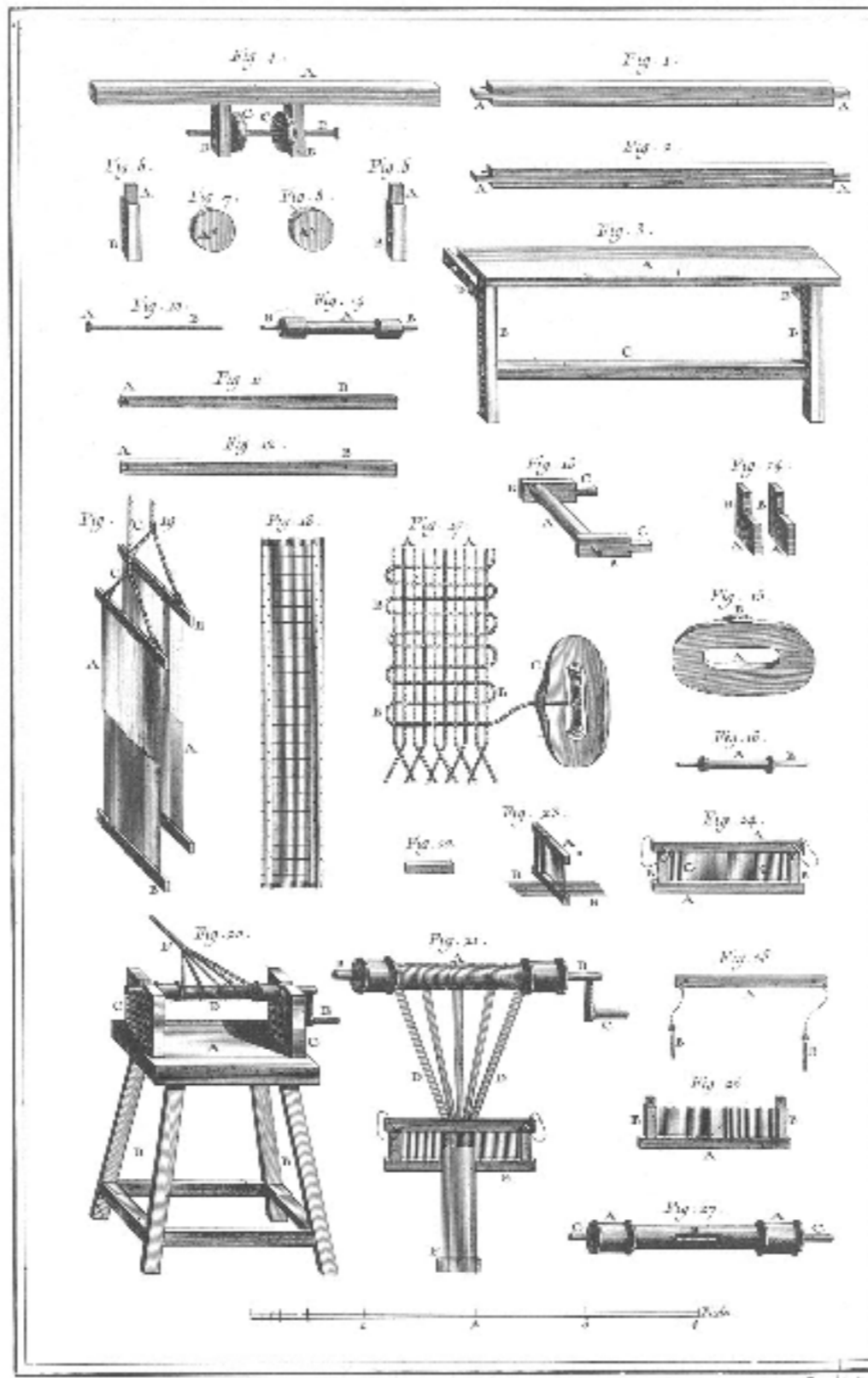

Each. N<sup>o</sup>. 1. Ensis. 100.

*Passementerie, détail du Métier à la Raie Laine et du Ployoir.*

“Passementerie, ...”  
 The Encyclopedia of Diderot & d'Alembert 1763  
 (University of Michigan)

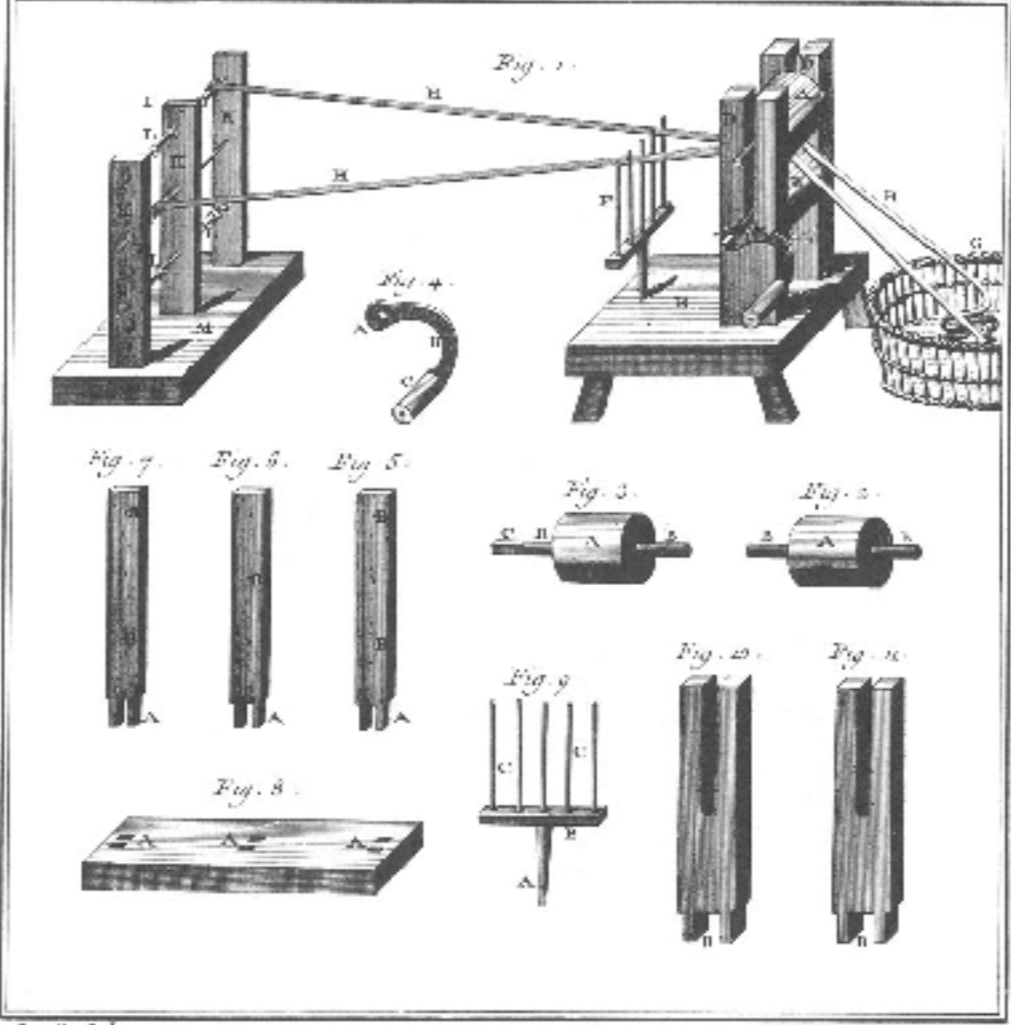

Inoffit Del.

Guarini Sculp.

*Passementerie, Façon de la Nampsville.*

“Passementerie, ...”  
 The Encyclopedia of Diderot & d'Alembert 1763  
 (University of Michigan)

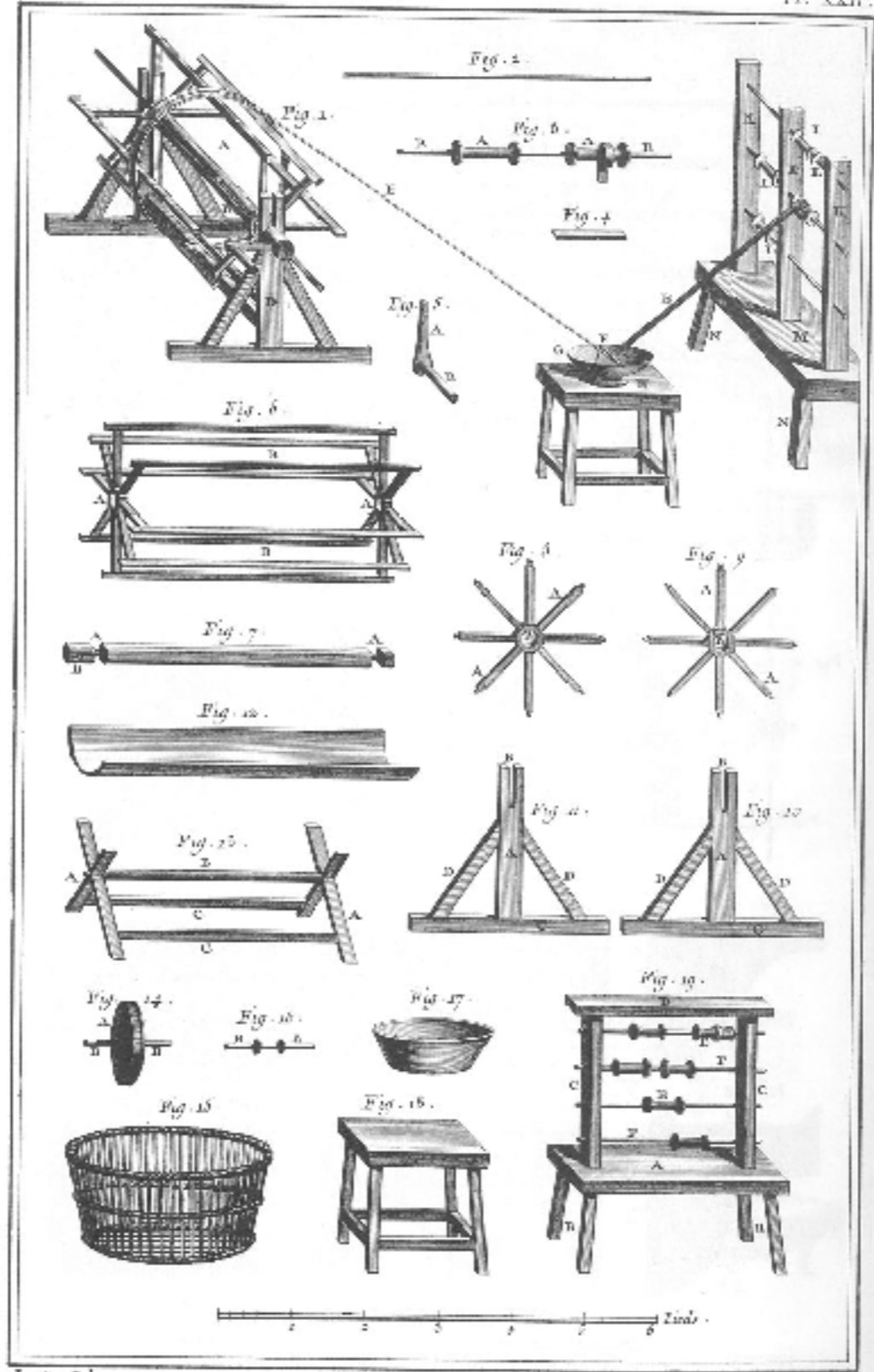

*Passementerie, détails des Outils propres à faire la Nonpareille.*

“Passementerie, ...”

The Encyclopedia of Diderot & d'Alembert 1763  
(University of Michigan)

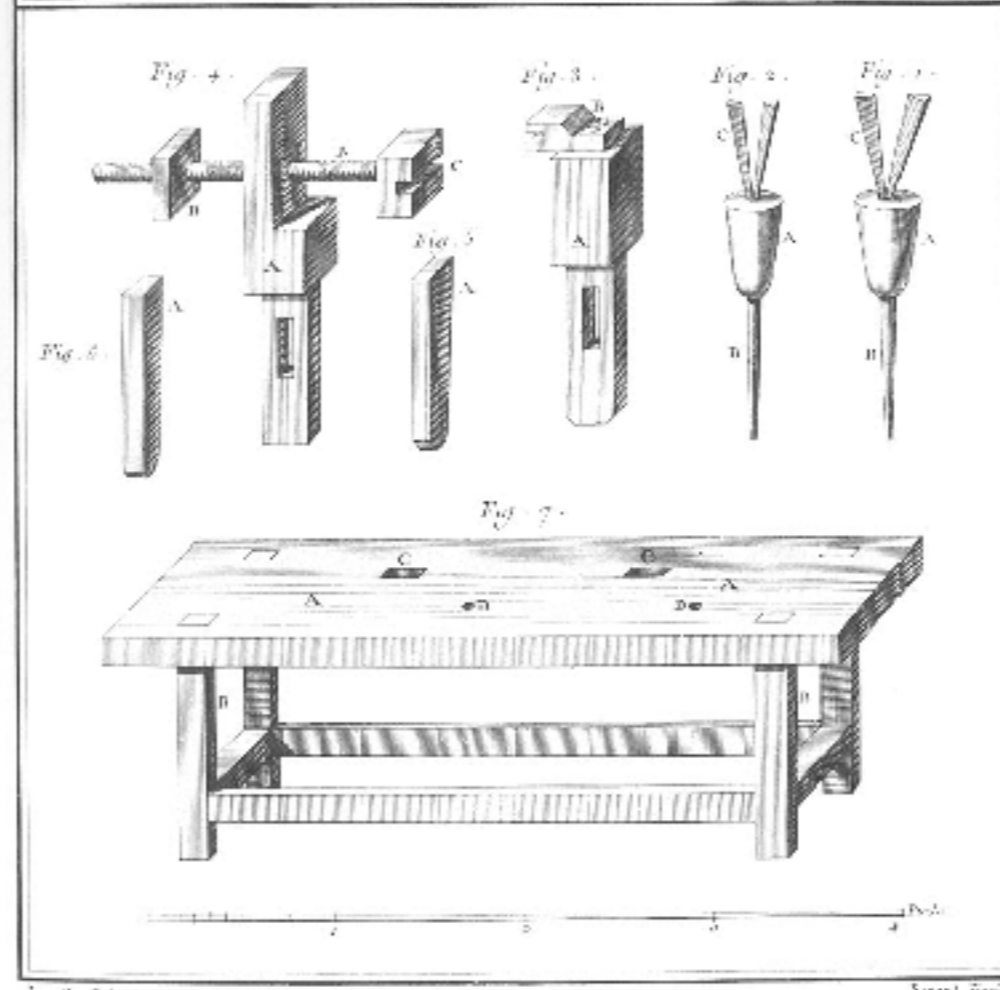
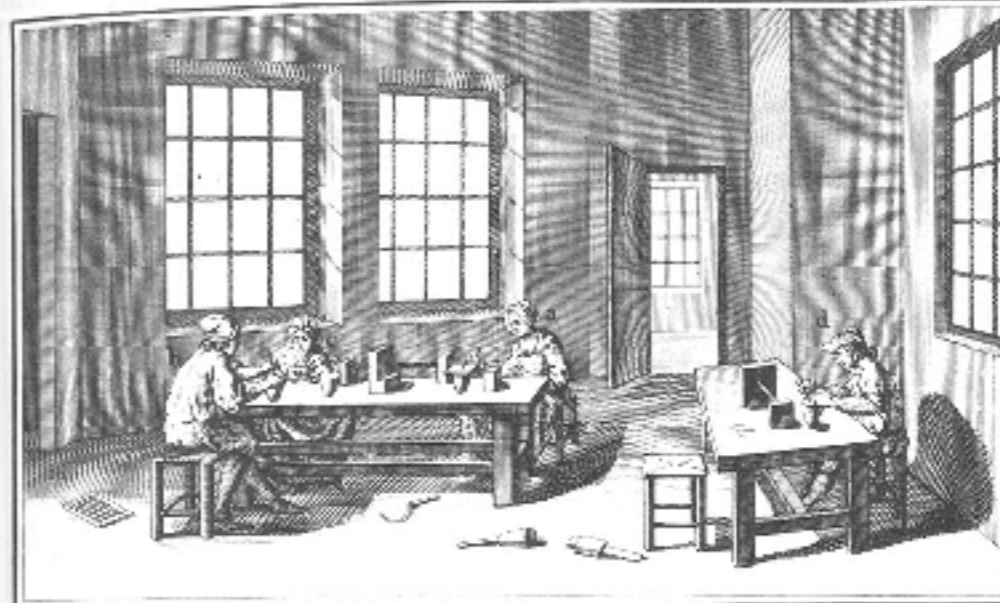

Lacouré del. Scudé Escut.

*Passementerie, Façon des Peçanes et Développemens.*

“Passementerie, ...”  
 The Encyclopedia of Diderot & d'Alembert 1763  
 (University of Michigan)

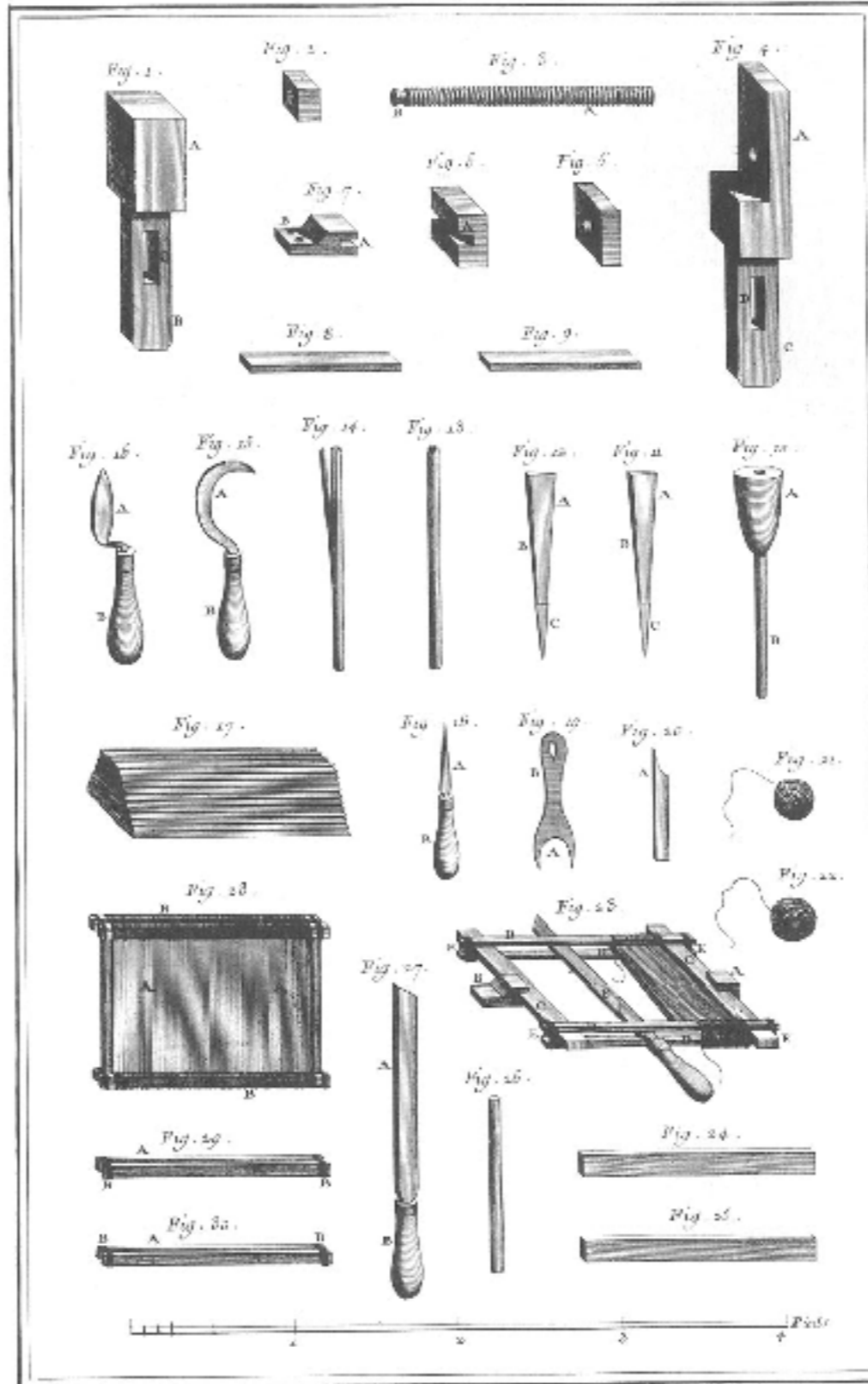

*Passenterie, détails pour la façon des Peignes.*

“Passenterie, ...”

The Encyclopedia of Diderot & d'Alembert 1763  
(University of Michigan)

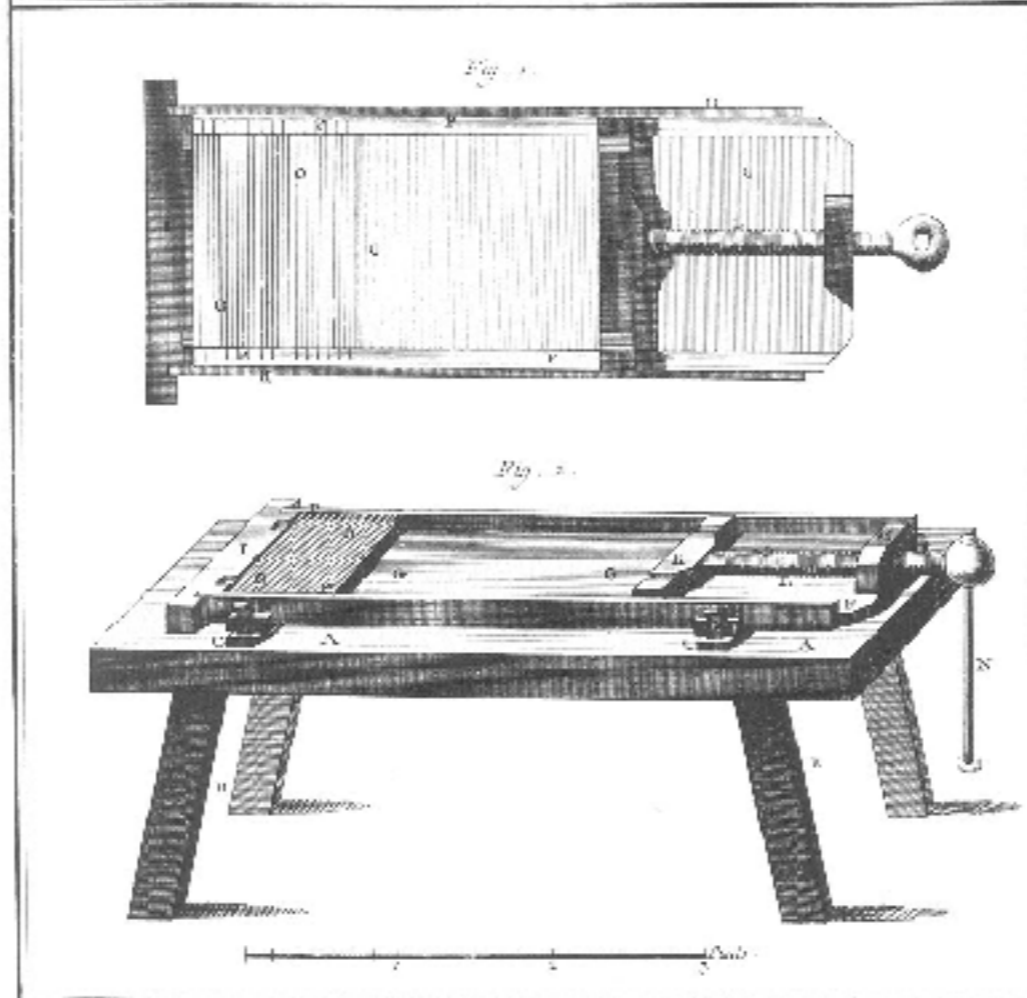
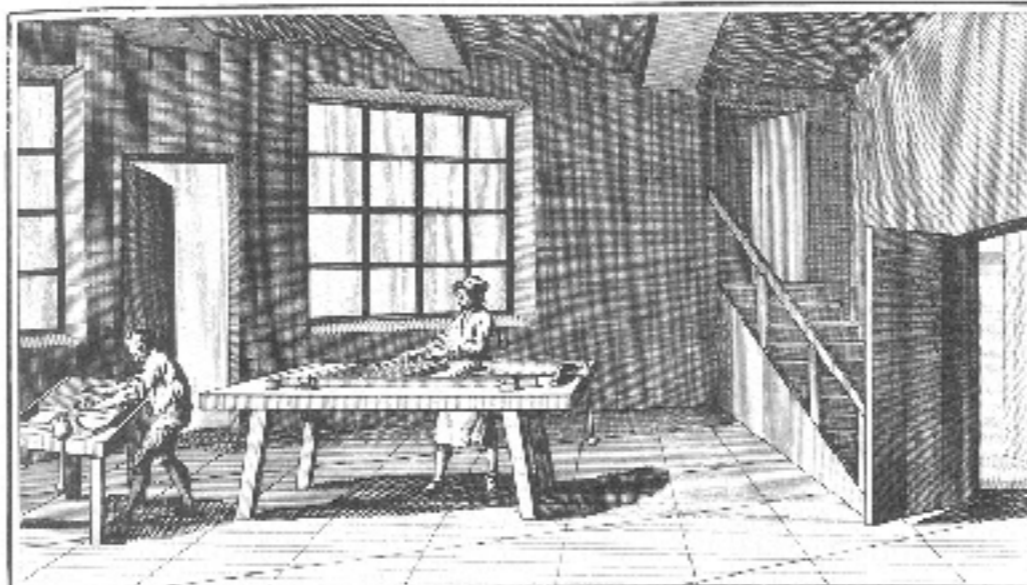

Leveque Del.

Benard Fecit.

*Passementerie, moyen des Péguas à la manière Angloise.*

“Passementerie, ...”  
 The Encyclopedia of Diderot & d'Alembert 1763  
 (University of Michigan)

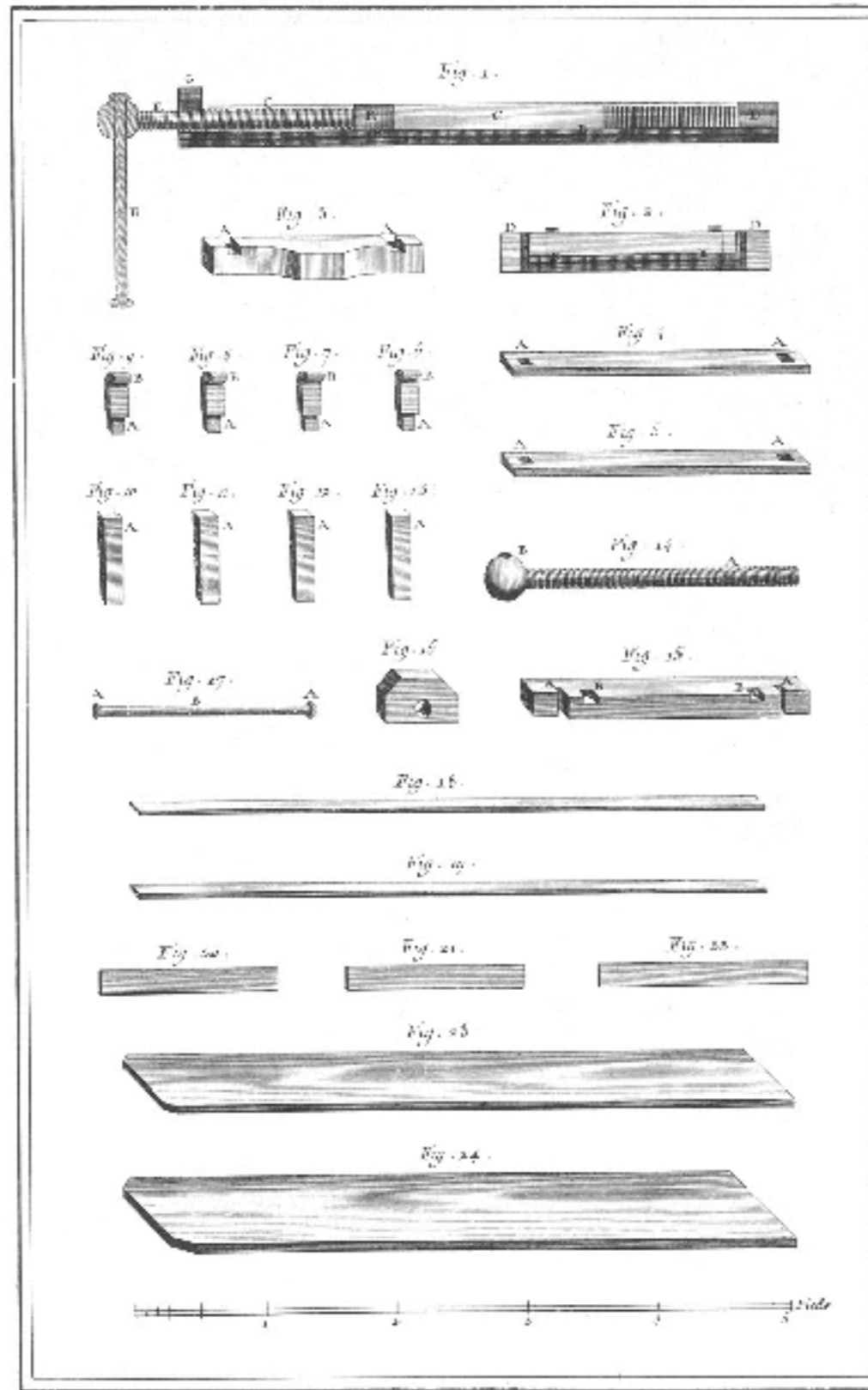

Leveur del.      Benoist del.

*Passementerie; D<sup>e</sup>tail de la Machine à monter les Triguans à la manière Angloise.*

“Passementerie, ...”

The Encyclopedia of Diderot & d'Alembert 1763  
(University of Michigan)

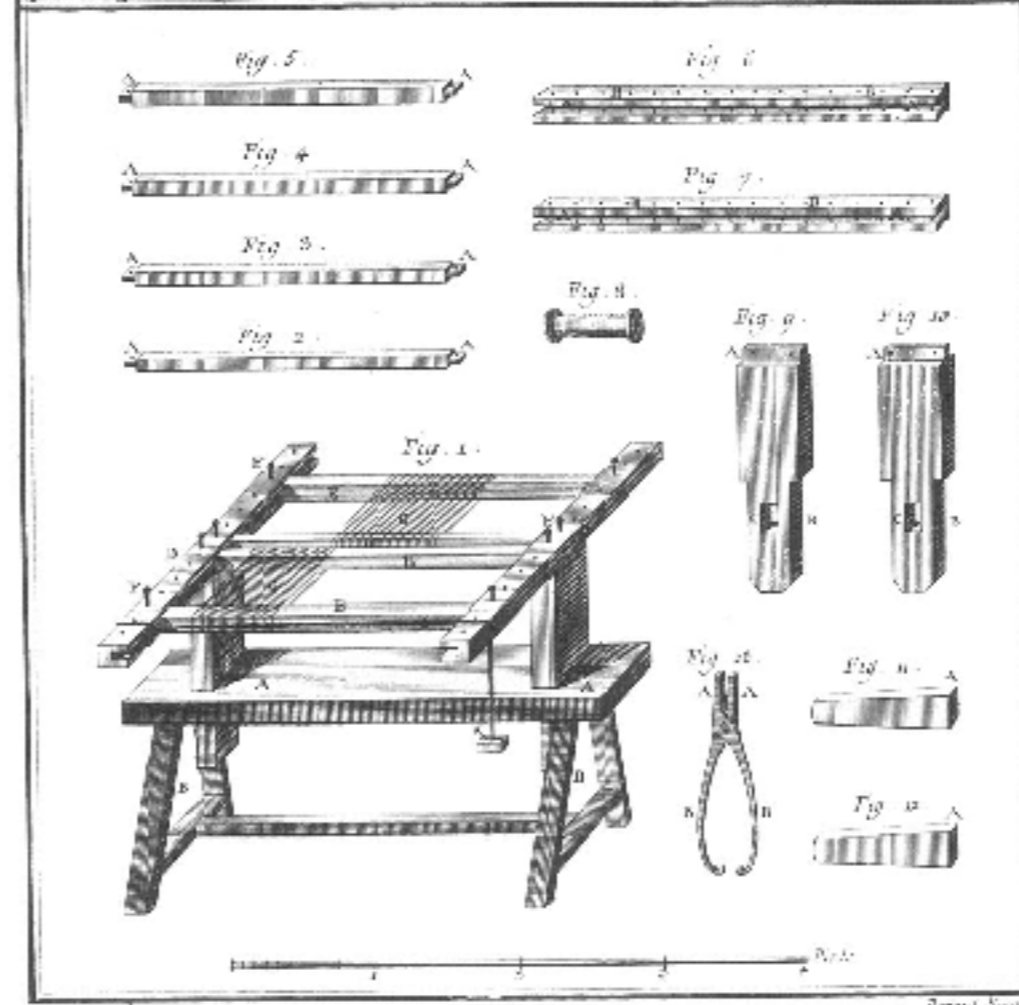
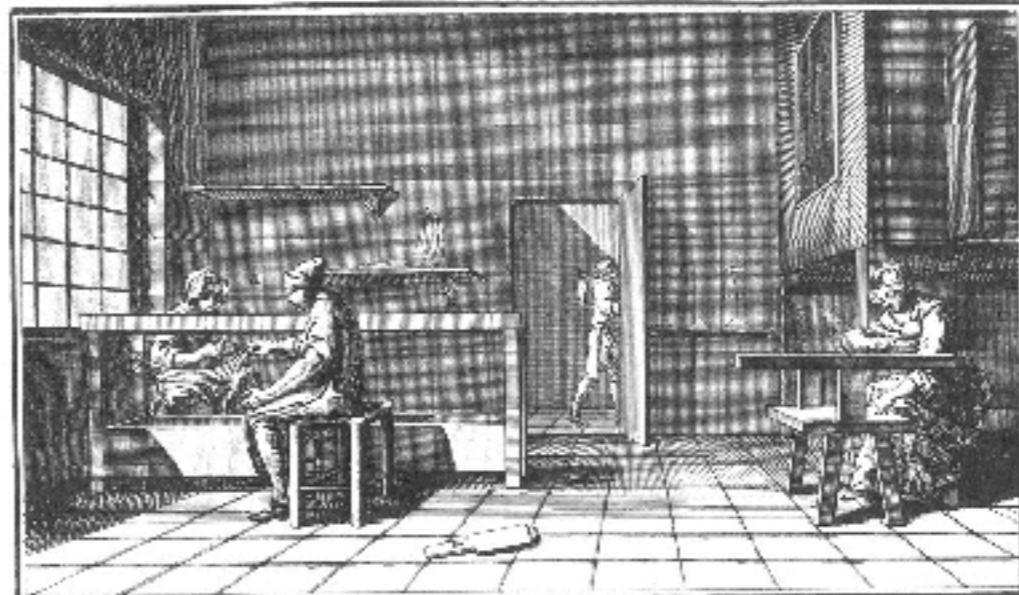

*Passementerie , Façon des Laffes .*

“Passementerie, ...”  
 The Encyclopedia of Diderot & d'Alembert 1763  
 (University of Michigan)

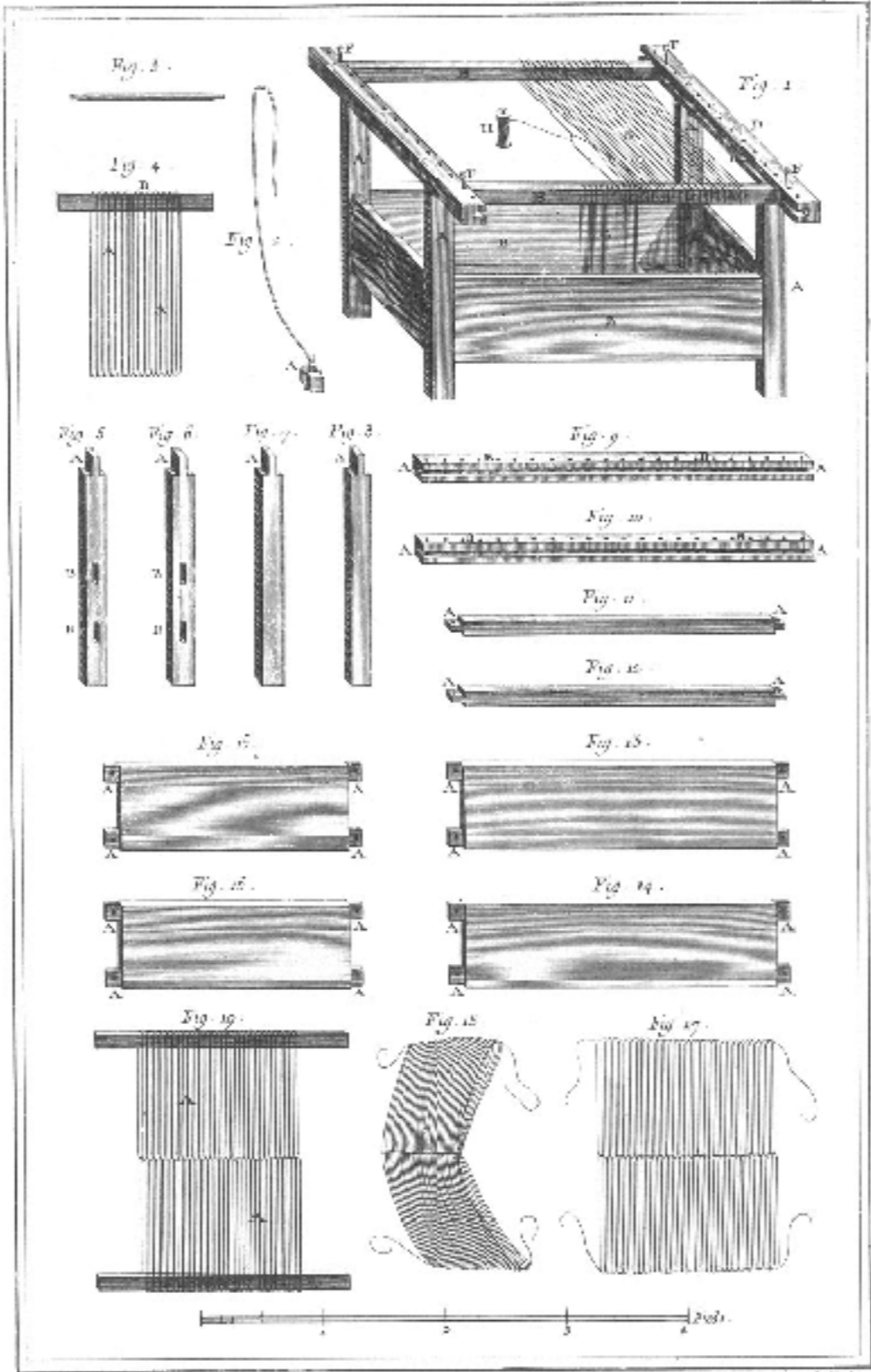

Leveillé Del.

Beaumont Sculp.

*Passenterie, Détails pour la façon des Liffes.*

“Passenterie, ...”

The Encyclopedia of Diderot & d'Alembert 1763  
(University of Michigan)

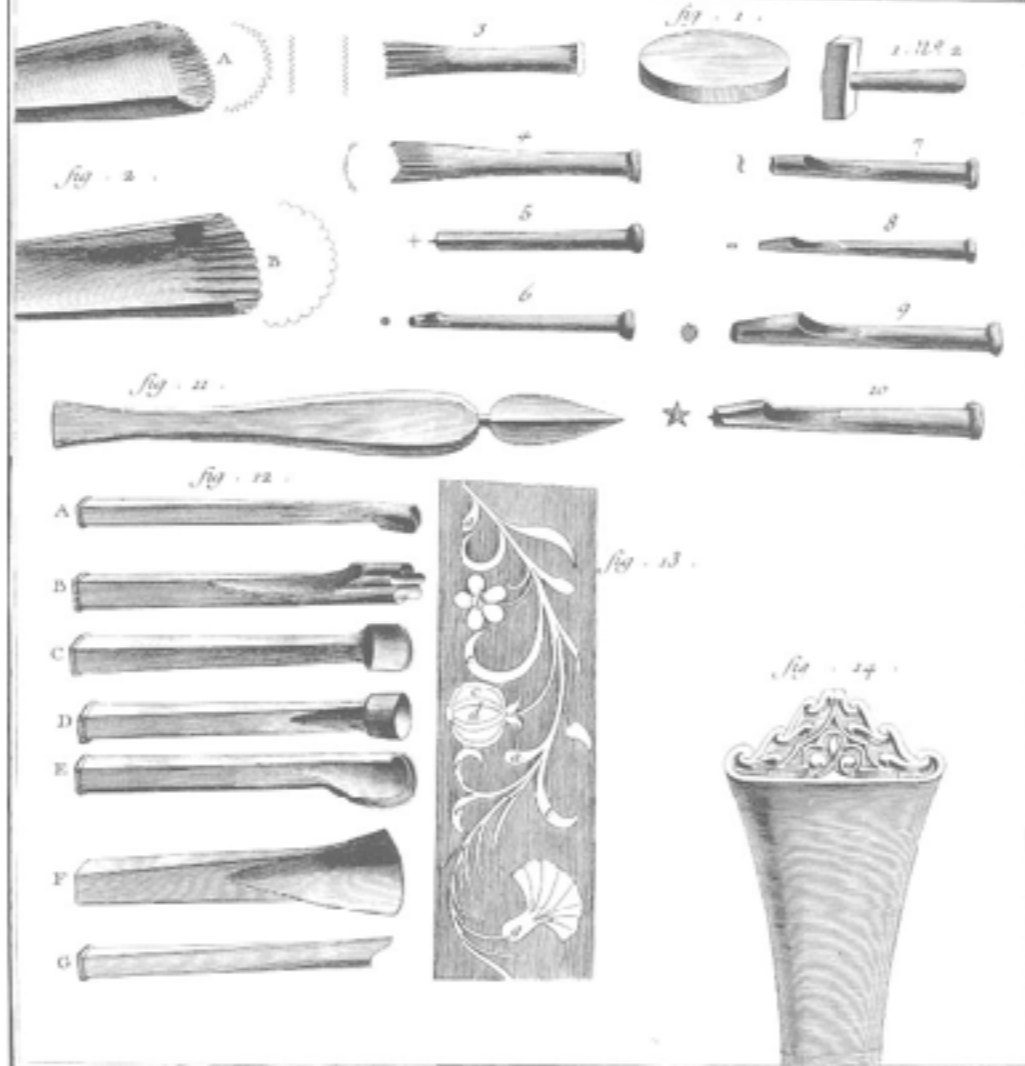
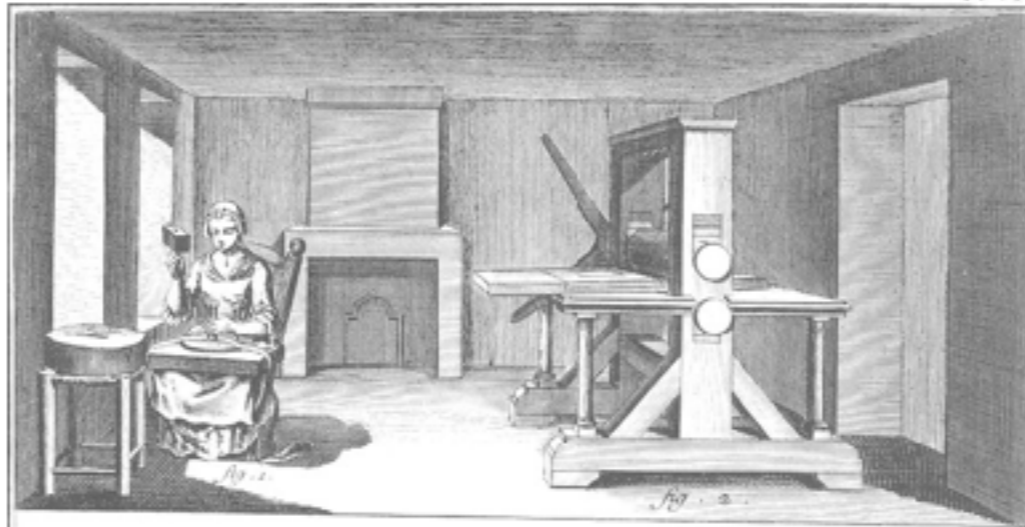

*Découpeur et Gausseur.*

“Découpeur et Gausseur.”  
 The Encyclopedia of Diderot & d'Alembert 1763  
 (University of Michigan)

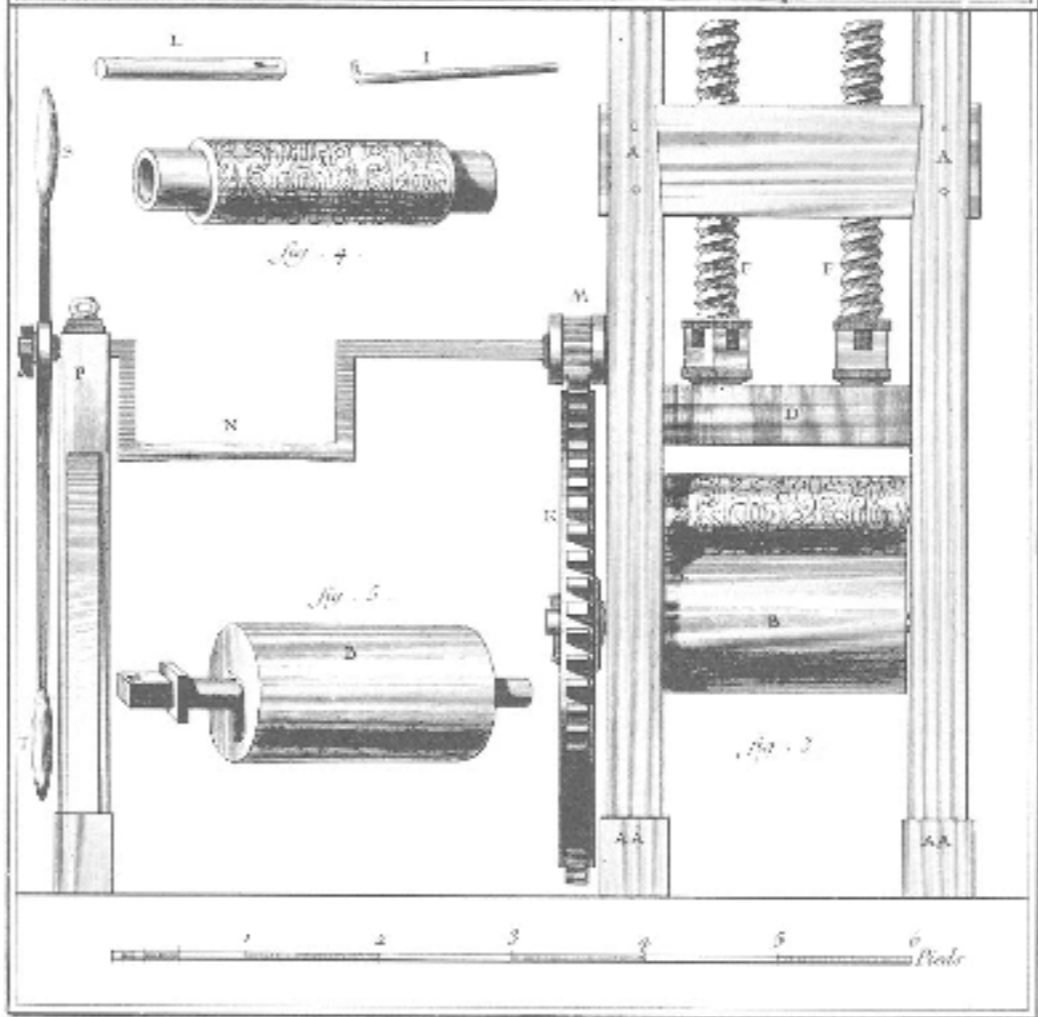
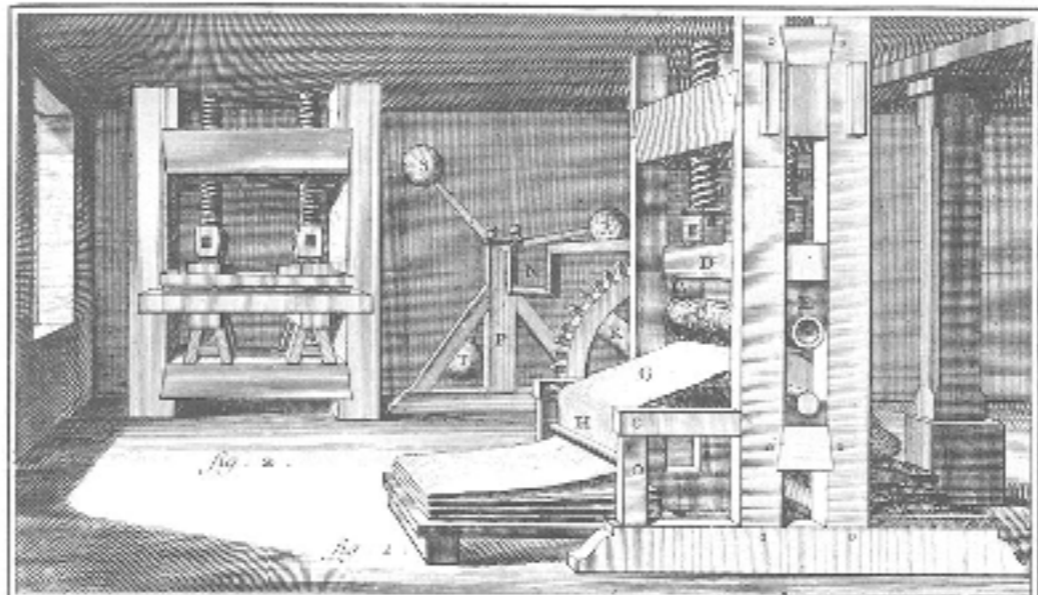

*Gravé par Del.*

*Découpeur et Gausseur.*

“Découpeur et Gausseur.”  
 The Encyclopedia of Diderot & d’Alembert 1763  
 (University of Michigan)

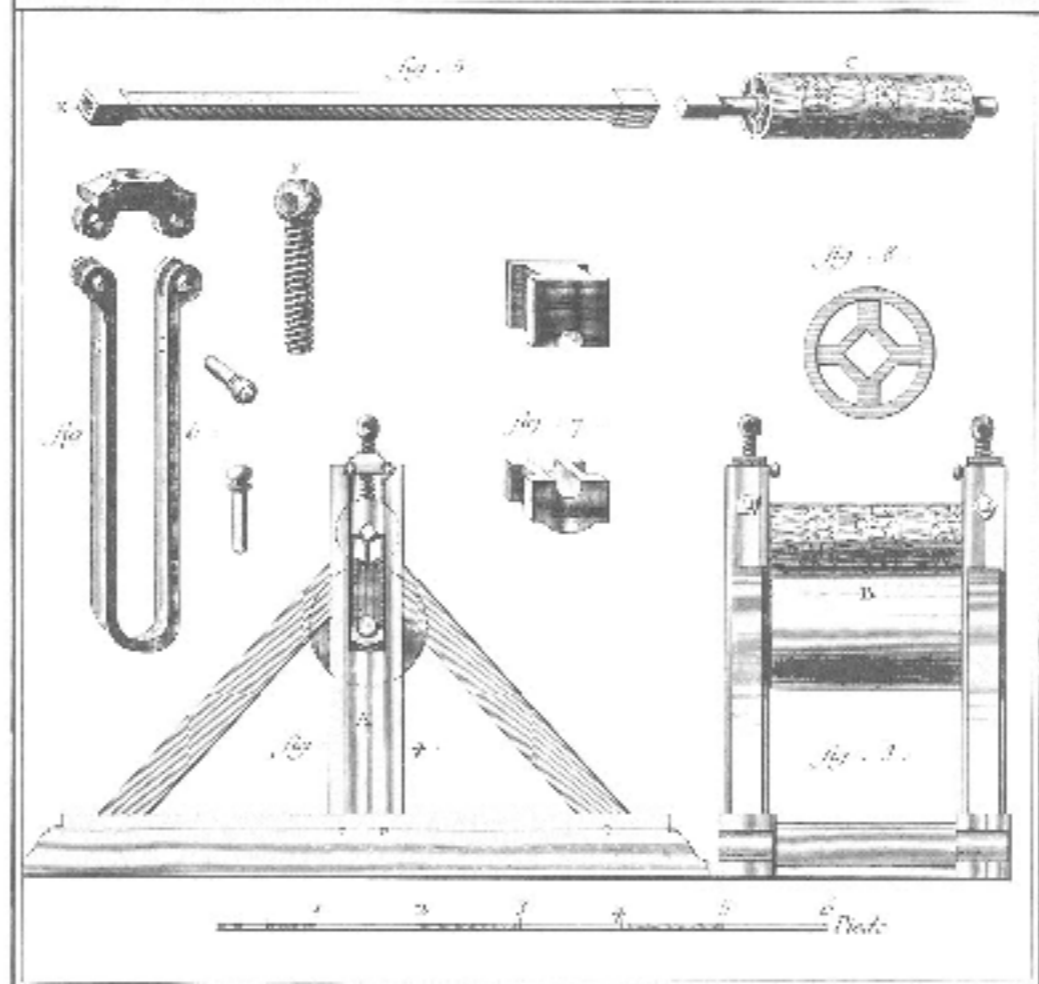
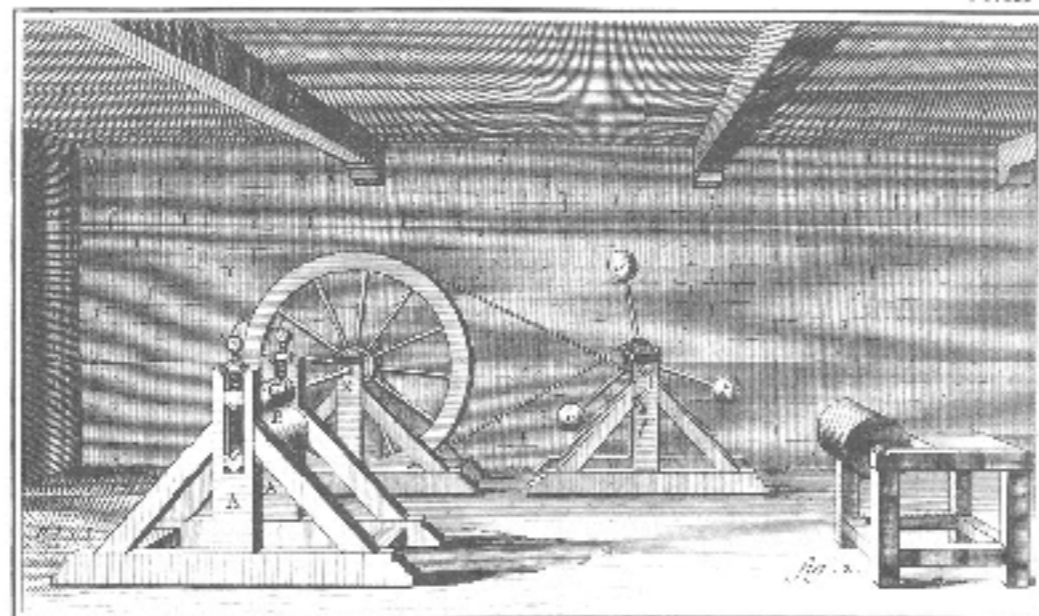

*Découpeur et Gouffreur.*

“Découpeur et Gouffreur.”  
 The Encyclopedia of Diderot & d'Alembert 1763  
 (University of Michigan)

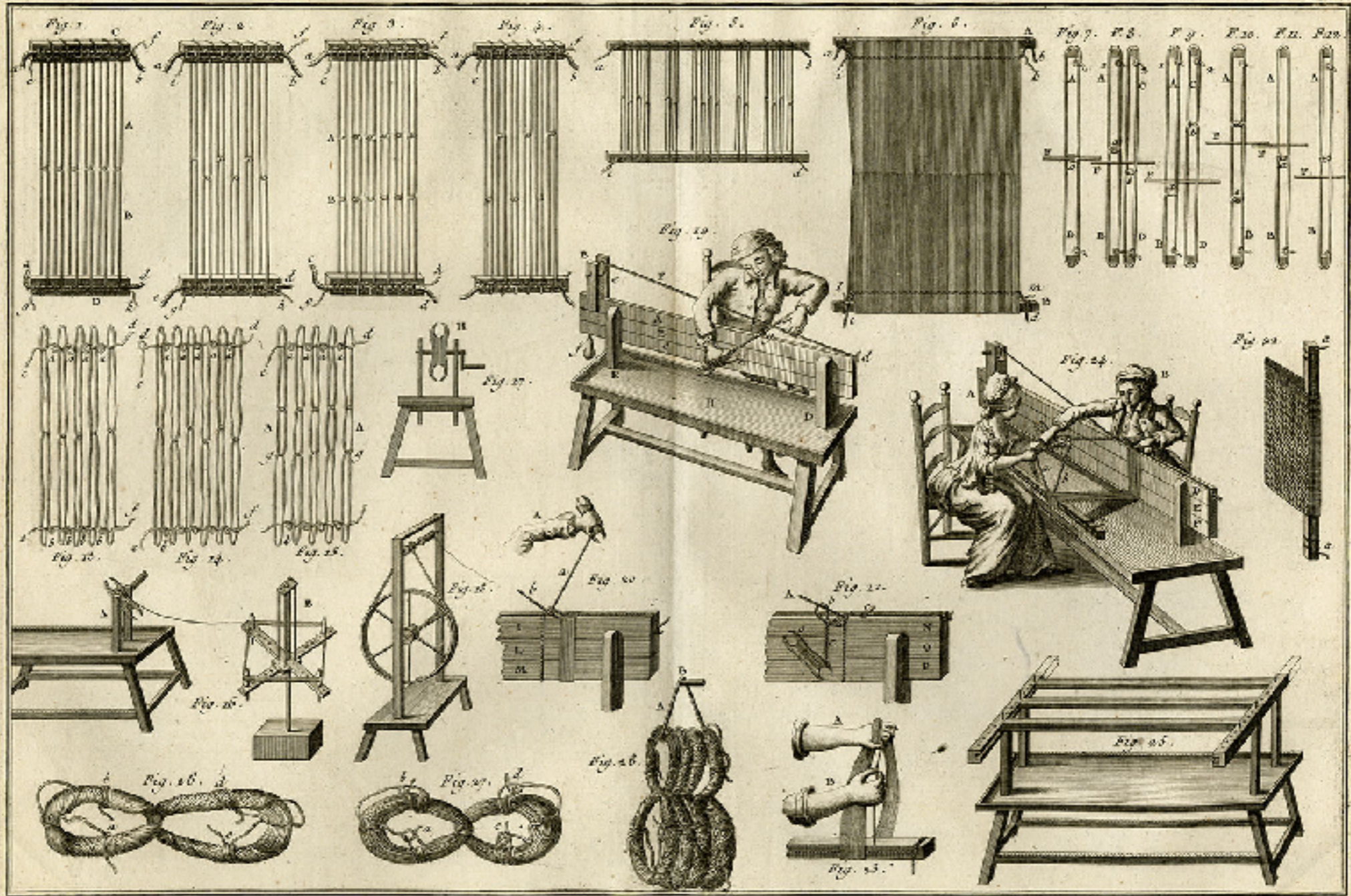

Lisses.

“Lisses”  
 The Encyclopedia of Diderot & d'Alembert 1763  
 (Private Collection - ebay)

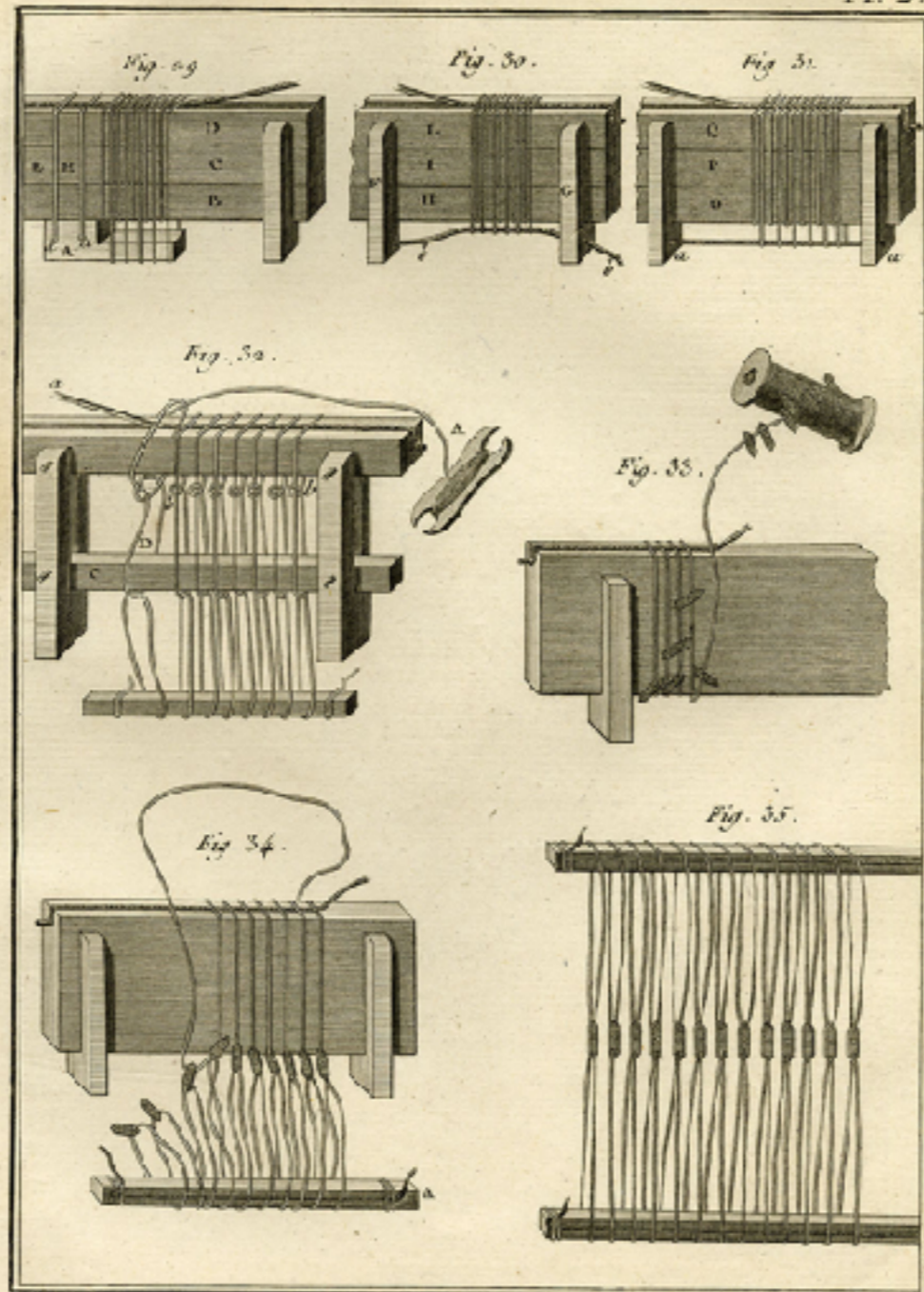

Lisses

45

“Lisses”  
The Encyclopedia of Diderot & d'Alembert 1763  
(Private Collection - ebay)

# Embroidery

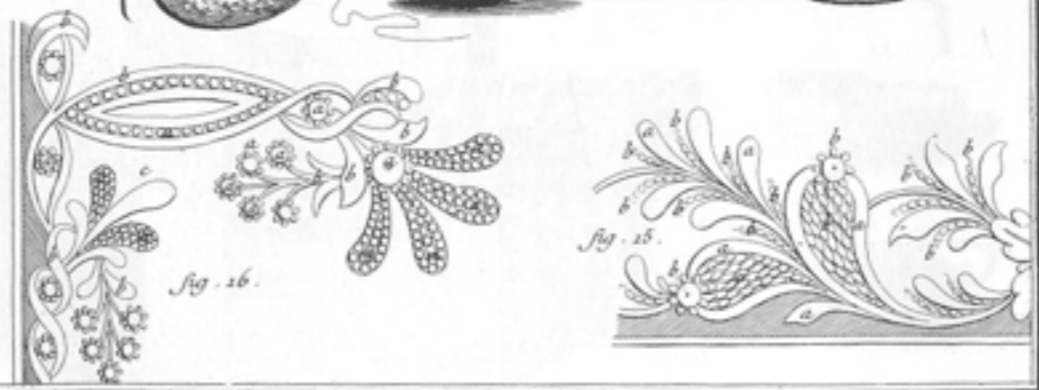
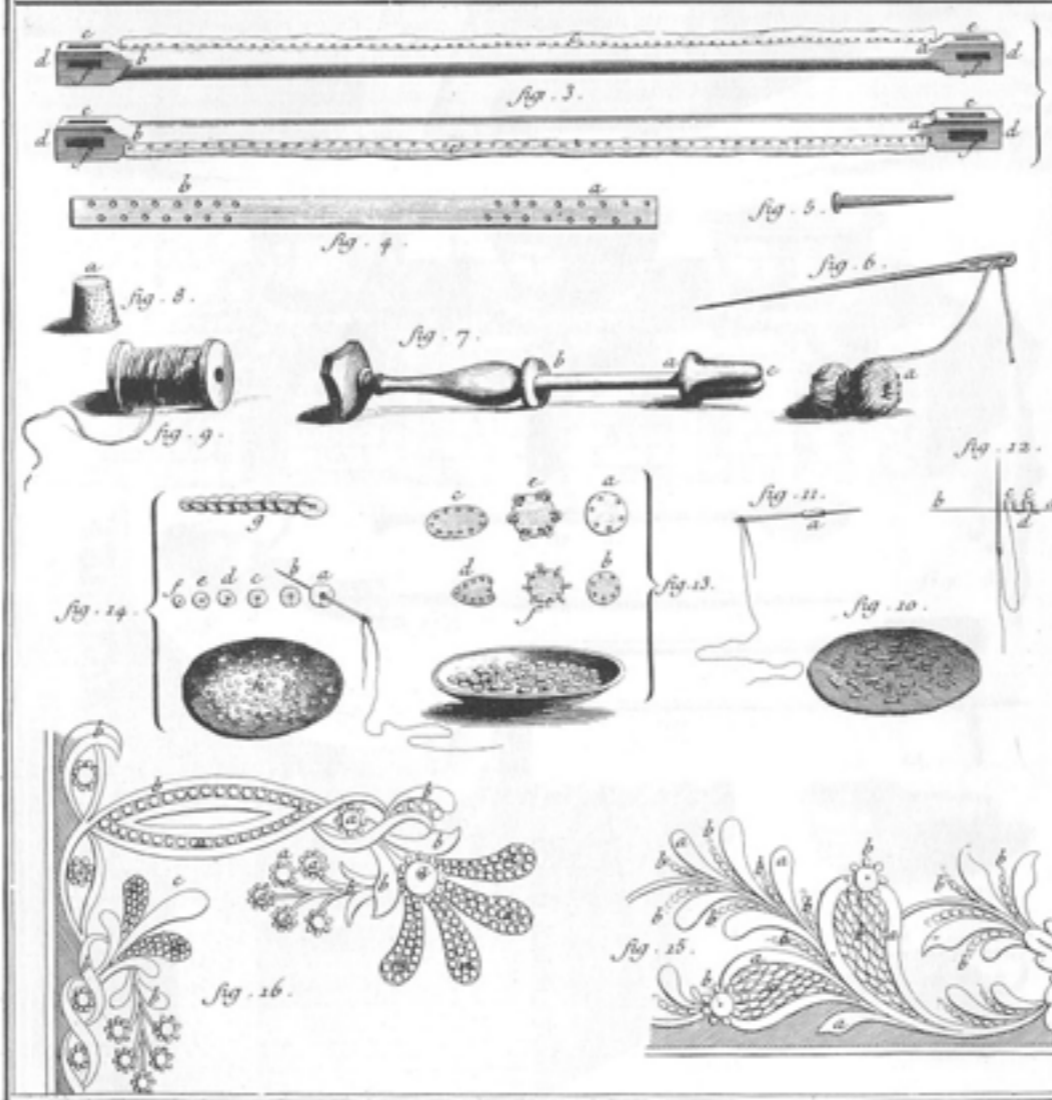
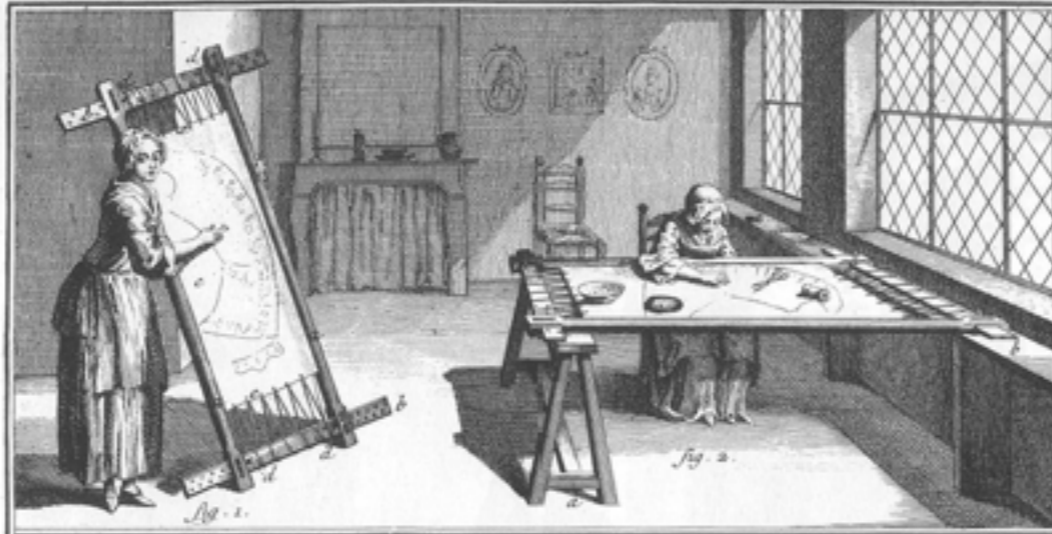

Brodeur.

“Brodeur.”

The Encyclopedia of Diderot & d'Alembert 1763  
(University of Michigan)

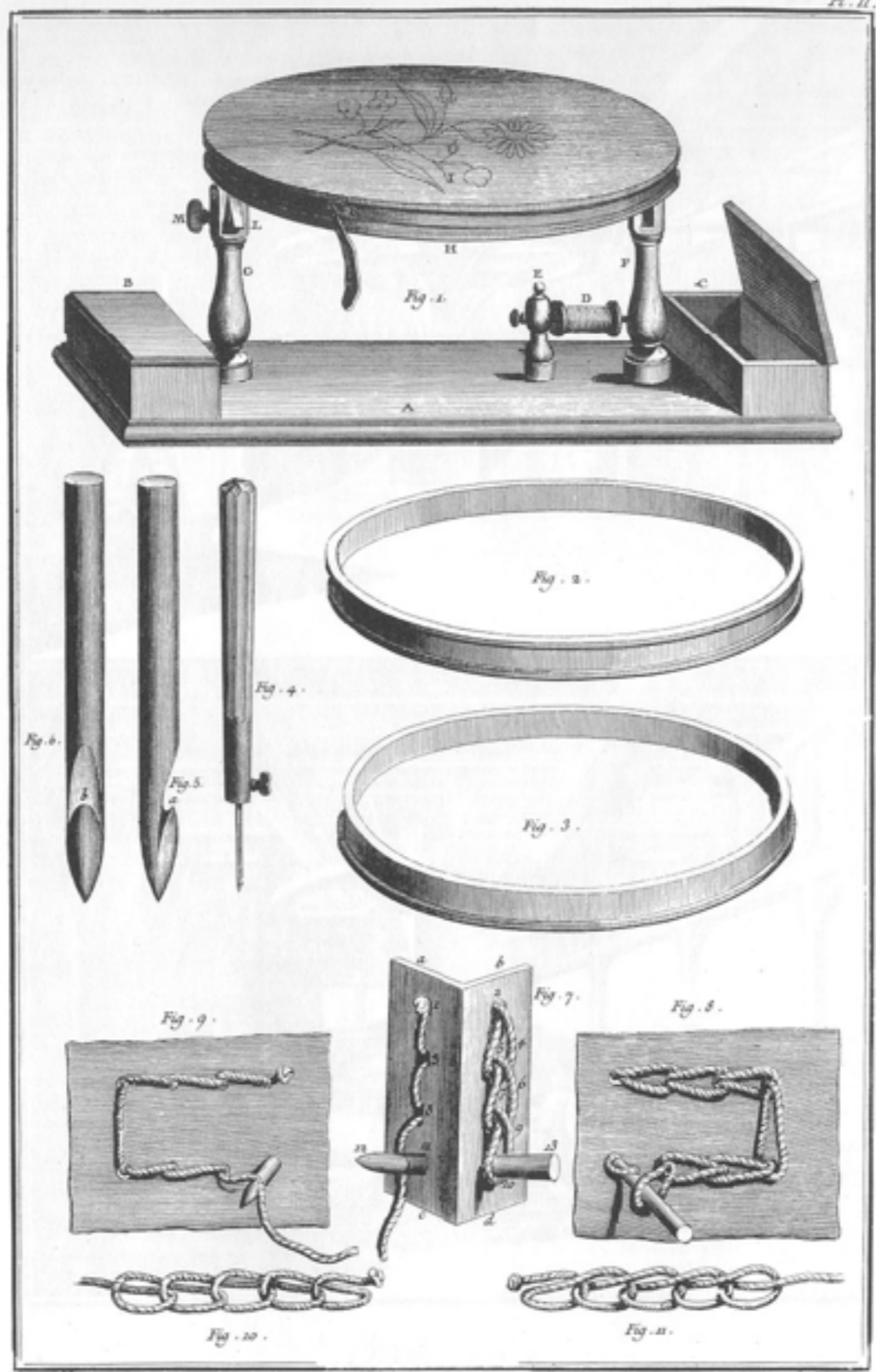

Brodeur,

“Brodeur.”

The Encyclopedia of Diderot & d'Alembert 1763  
(University of Michigan)

# Ribbon Production

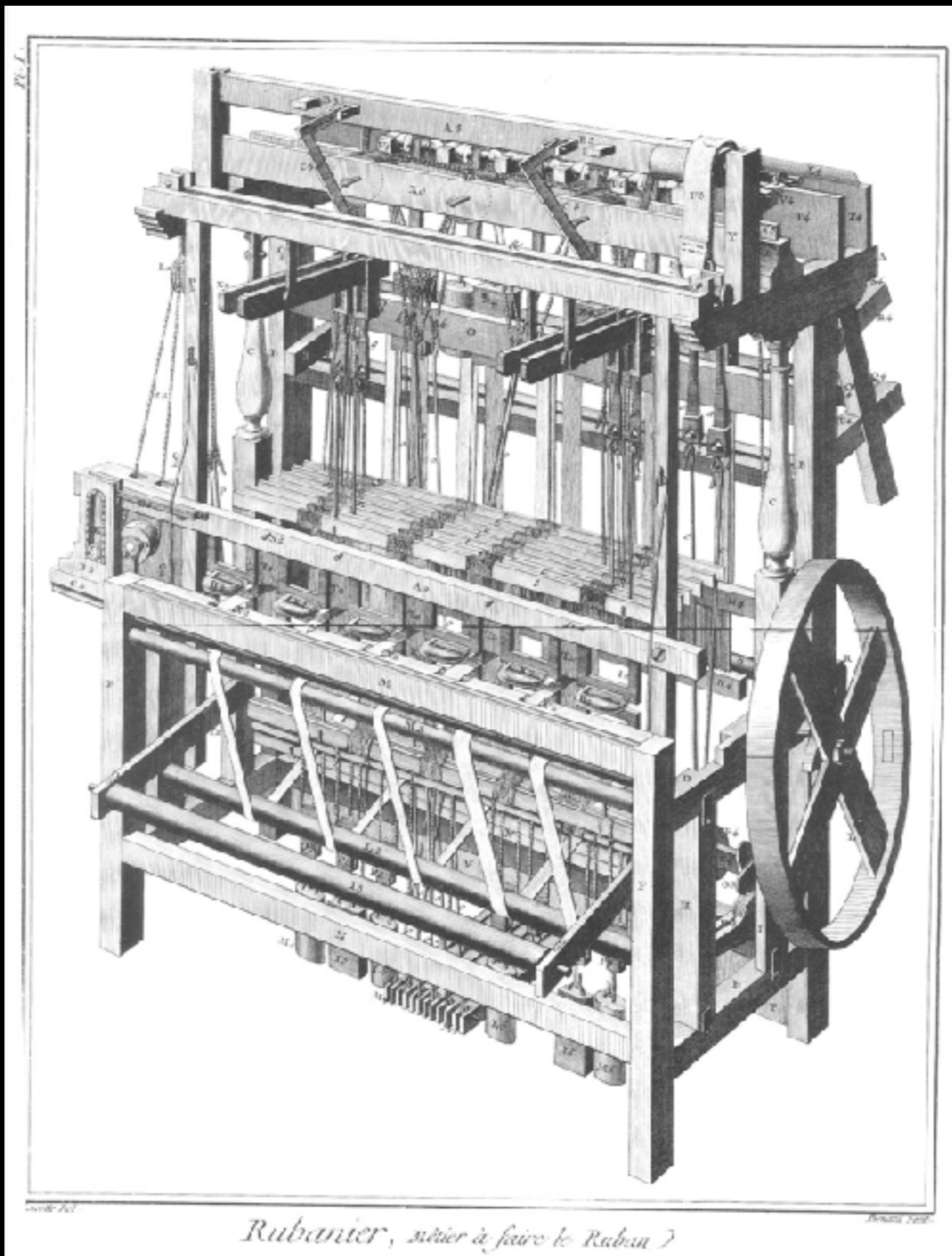

*Rubanier, métier à faire le Ruban*

“Rubanier, ...” Ribbon Maker  
The Encyclopedia of Diderot & d'Alembert 1763  
(University of Michigan)

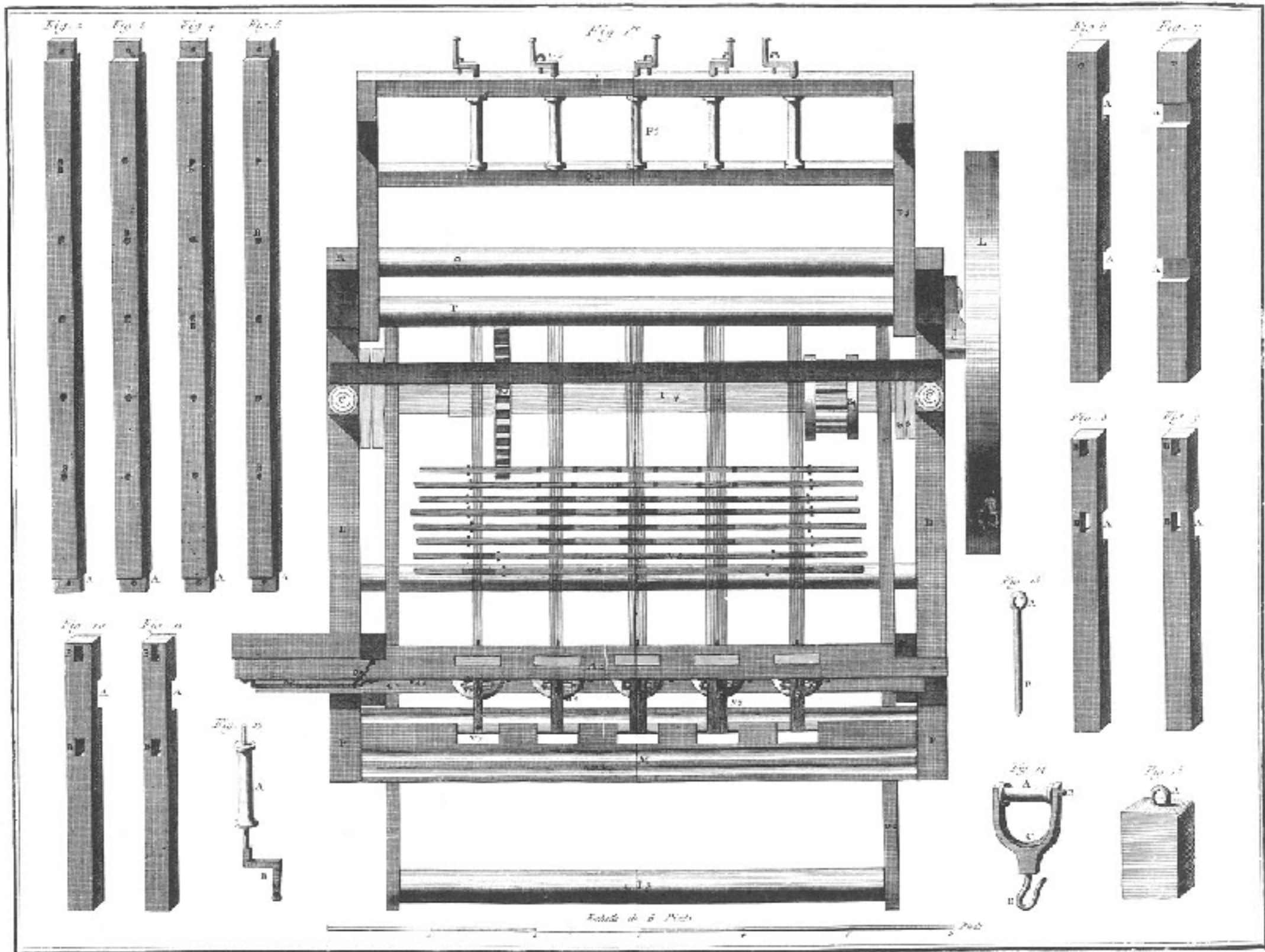

*Métier à Ruban, Plan 300 Lances.*

“Métier a faire le Ruban, ...” Ribbon Maker  
 The Encyclopedia of Diderot & d'Alembert 1763  
 (University of Michigan)

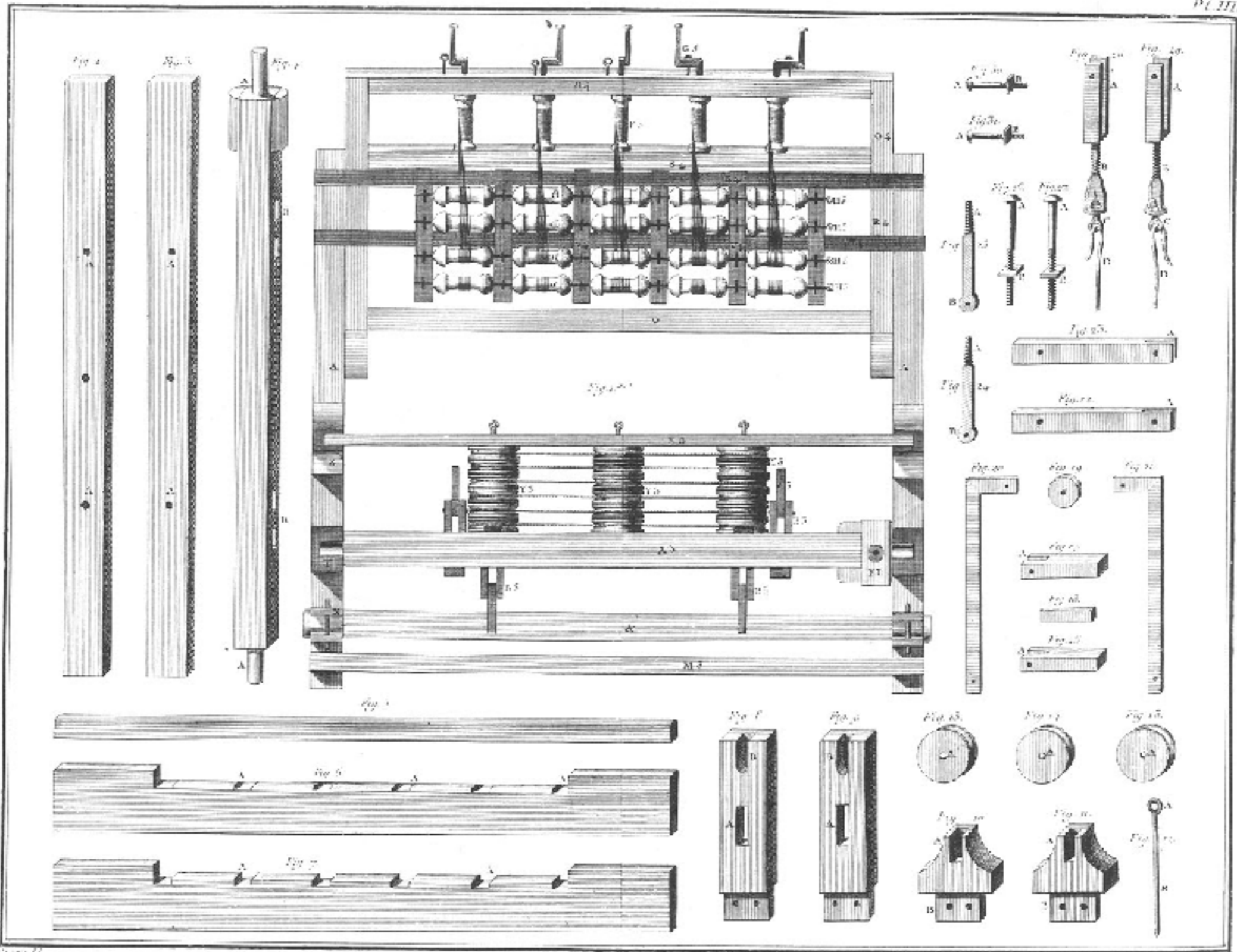

*Métier à faire le Ruban. Plan du définit.*

“Métier a faire le Ruban, ...” Ribbon Maker  
 The Encyclopedia of Diderot & d'Alembert 1763  
 (University of Michigan)

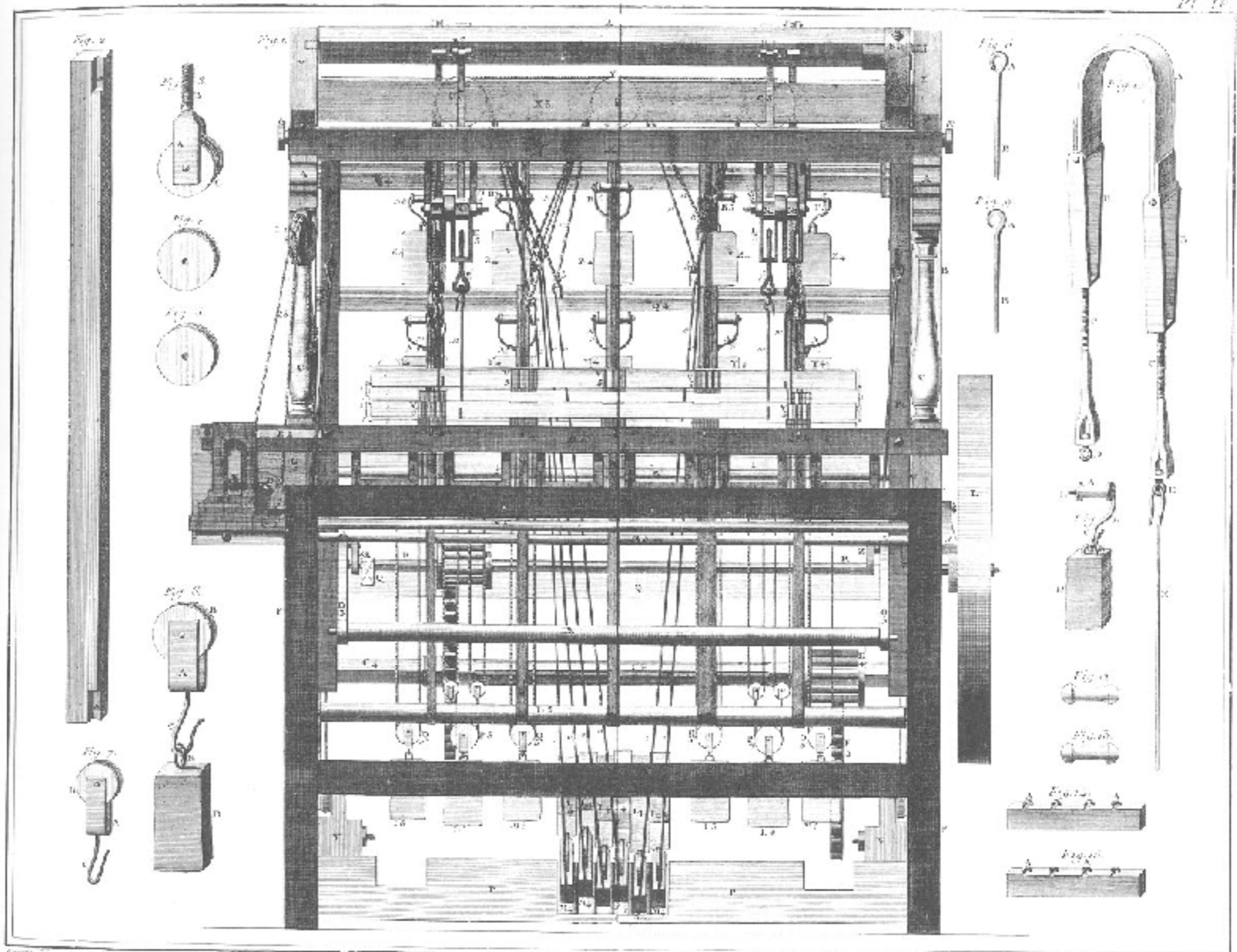

*Métier à faire le Ruban, Étendue en face.*

“Métier a faire le Ruban, ...” Ribbon Maker  
The Encyclopedia of Diderot & d'Alembert 1763  
(University of Michigan)

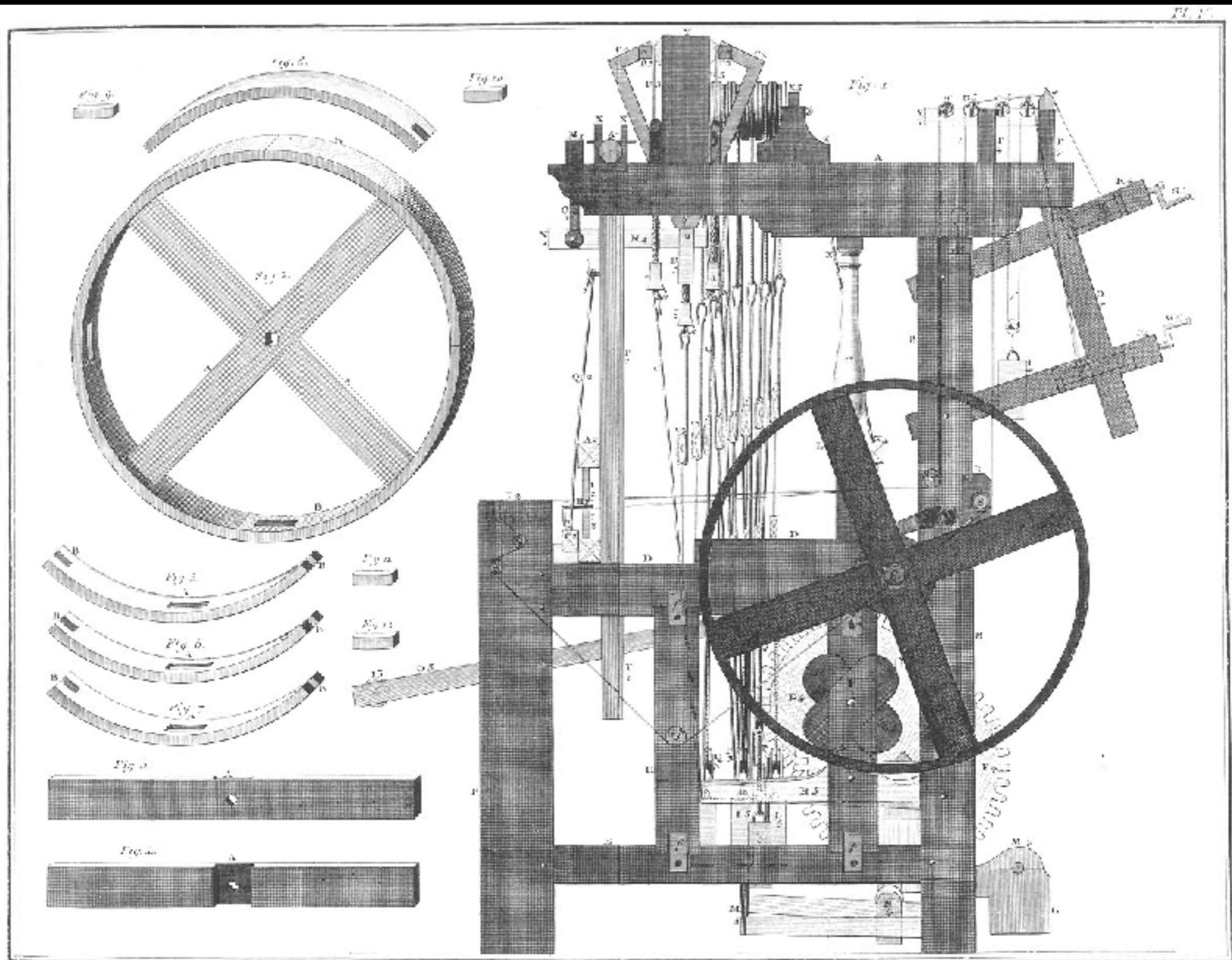

*Métier à faire le Ruban, invention récente.*

“Métier a faire le Ruban, ...” Ribbon Maker  
The Encyclopedia of Diderot & d'Alembert 1763  
(University of Michigan)

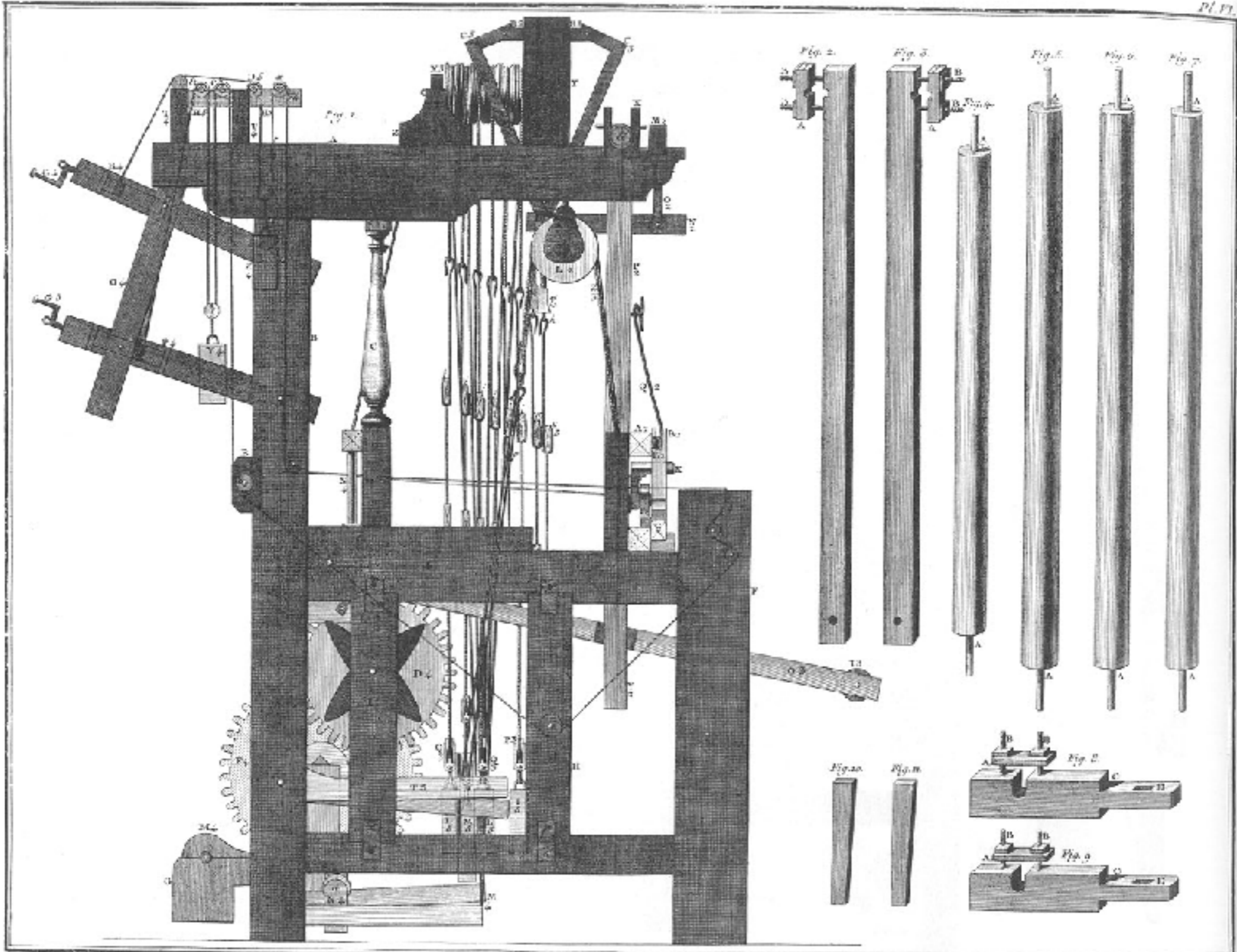

*Métier à faire le Ruban, fabrication latérale.*

“Métier a faire le Ruban, ...” Ribbon Maker  
 The Encyclopedia of Diderot & d'Alembert 1763  
 (University of Michigan)

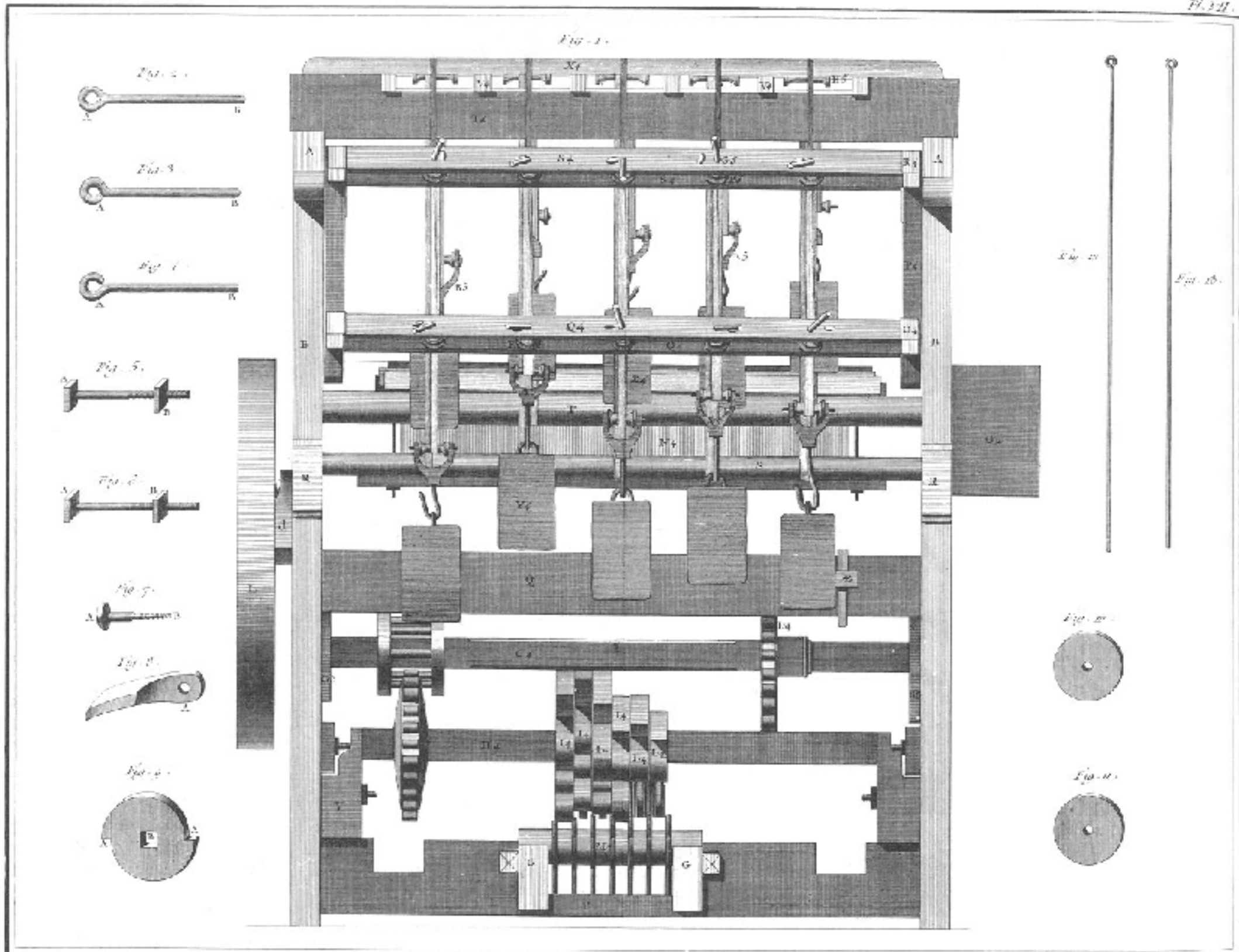

*Métier à faire le Ruban, élévation par derrière.*

“Métier a faire le Ruban, ...” Ribbon Maker  
 The Encyclopedia of Diderot & d'Alembert 1763  
 (University of Michigan)

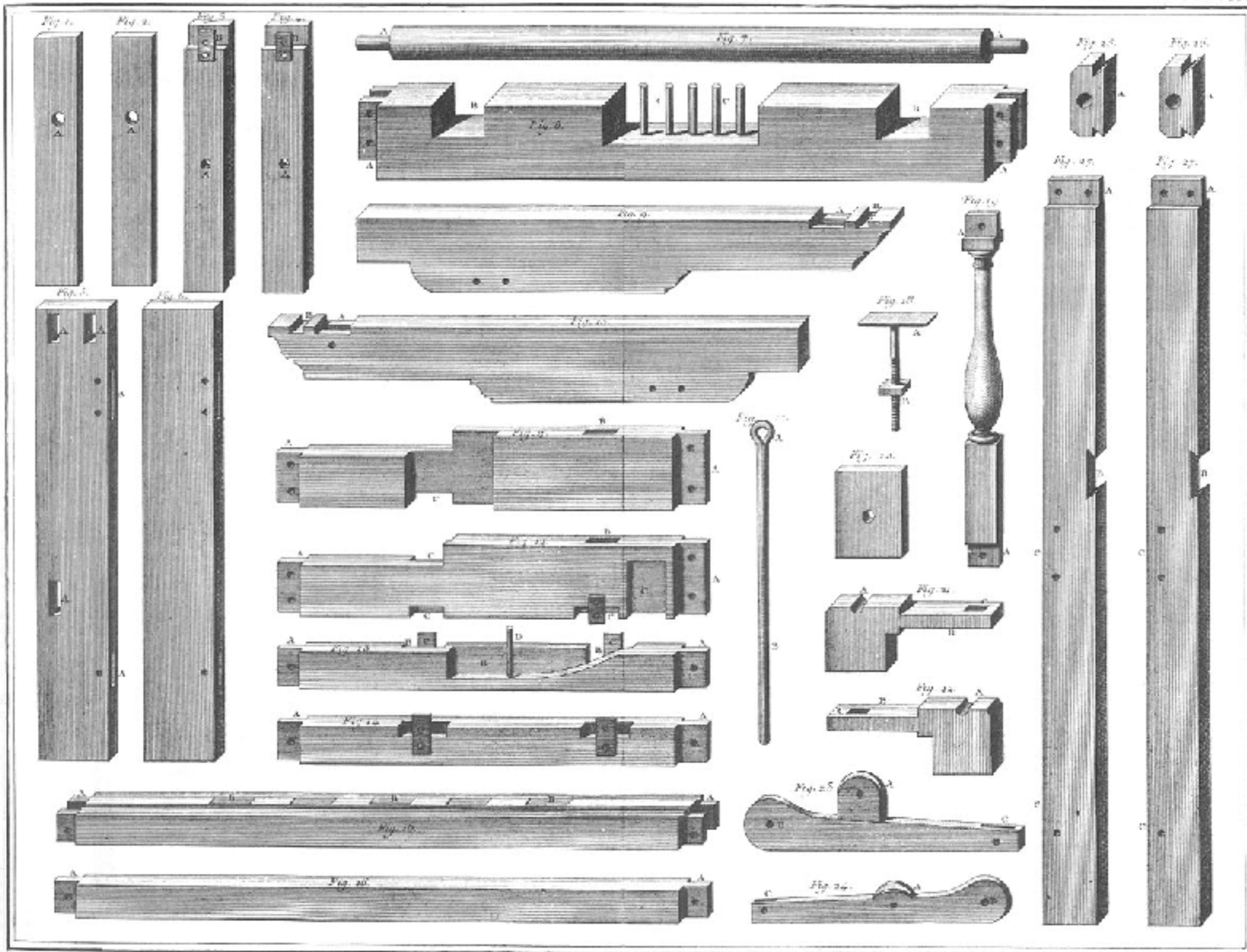

*Métier à faire le Ruban, Développement.*

“Métier a faire le Ruban, ...” Ribbon Maker  
The Encyclopedia of Diderot & d'Alembert 1763  
(University of Michigan)

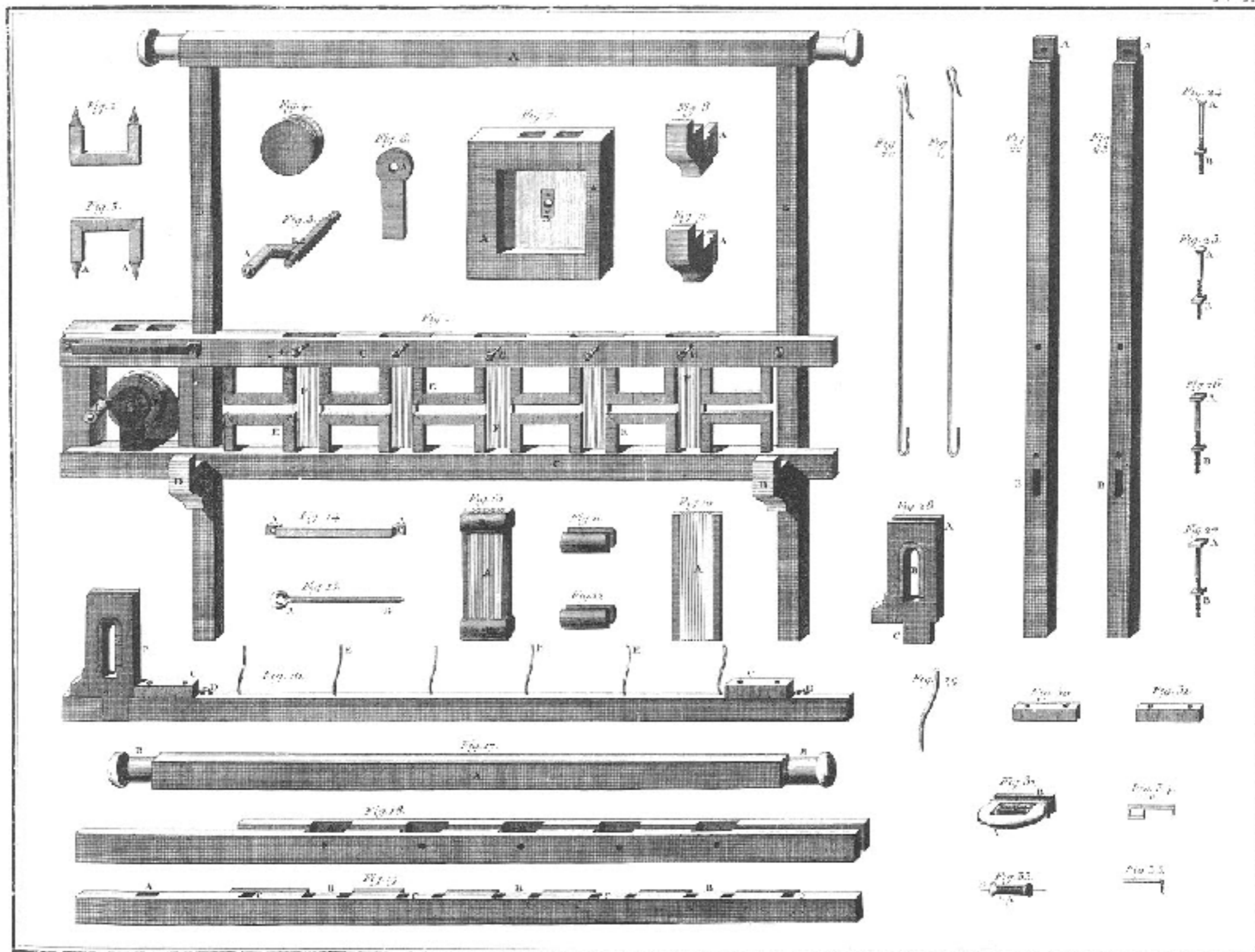

*Métier à faire le Ruban, Développement.*

“Métier a faire le Ruban, ...” Ribbon Maker  
The Encyclopedia of Diderot & d'Alembert 1763  
(University of Michigan)

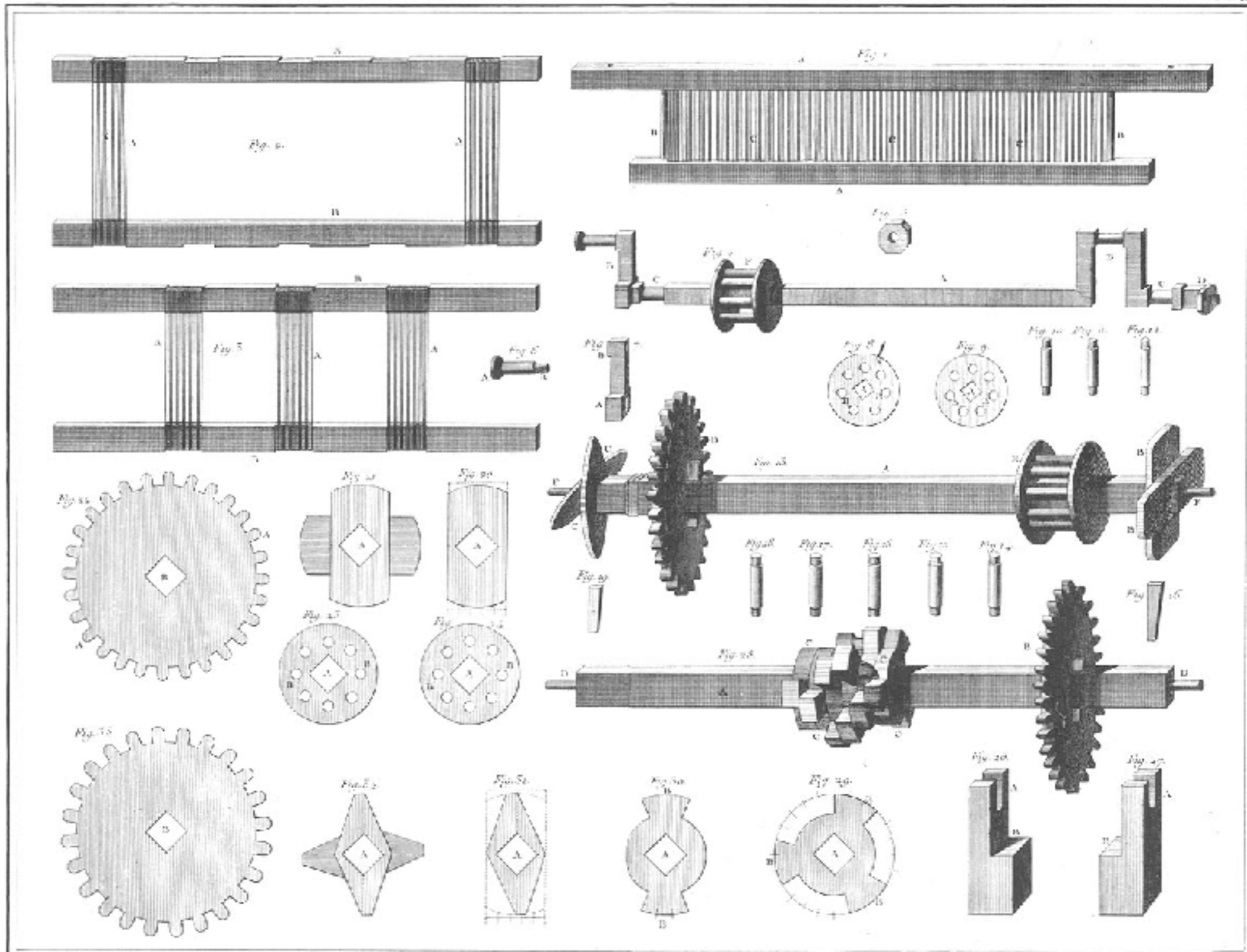

*Métier à faire le Ruban, Développement.*

“Métier a faire le Ruban, ...” Ribbon Maker  
 The Encyclopedia of Diderot & d'Alembert 1763  
 (University of Michigan)

# Textile Bleaching

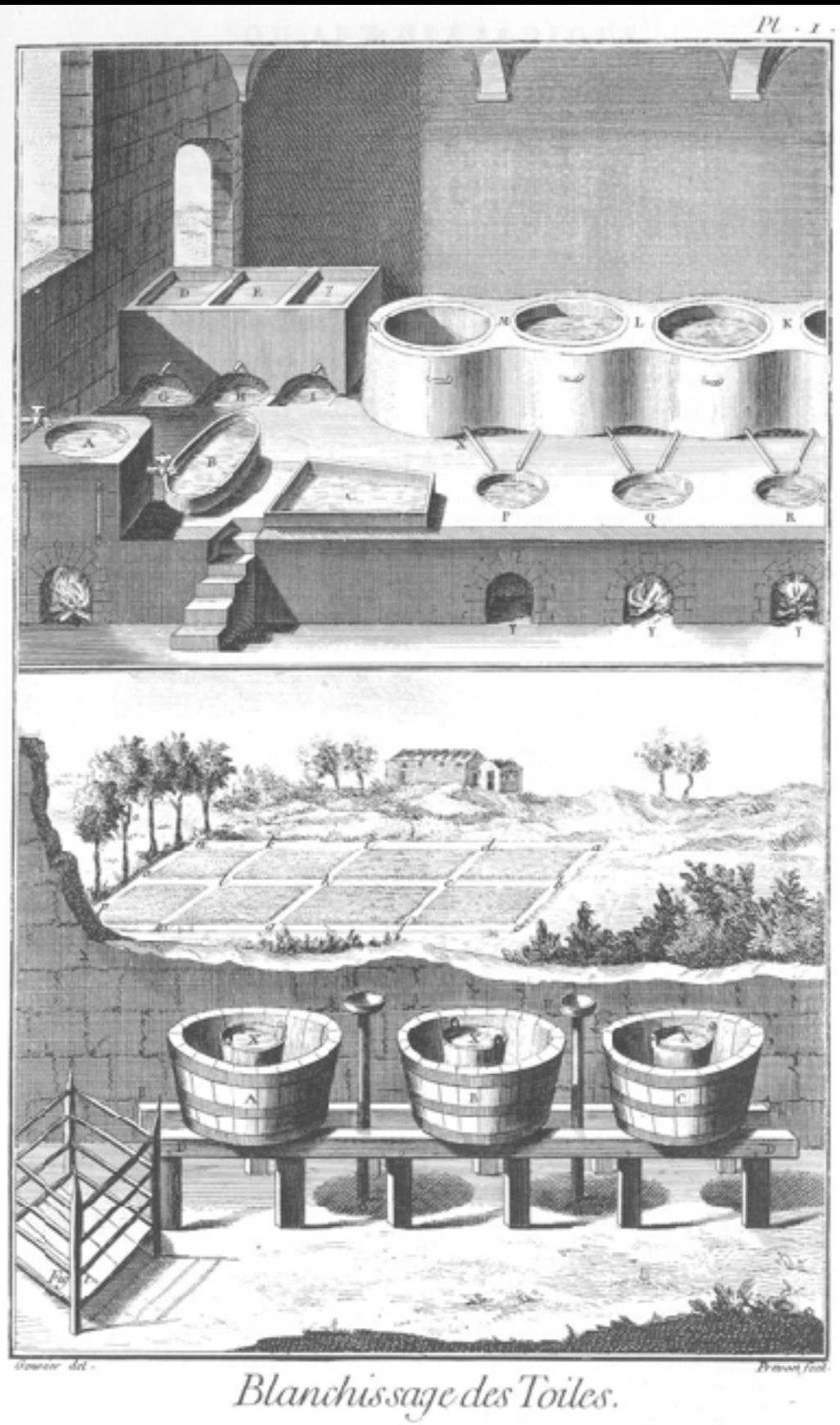

“Blanchissage des Toiles.”  
The Encyclopedia of Diderot & d'Alembert 1763  
(University of Michigan)

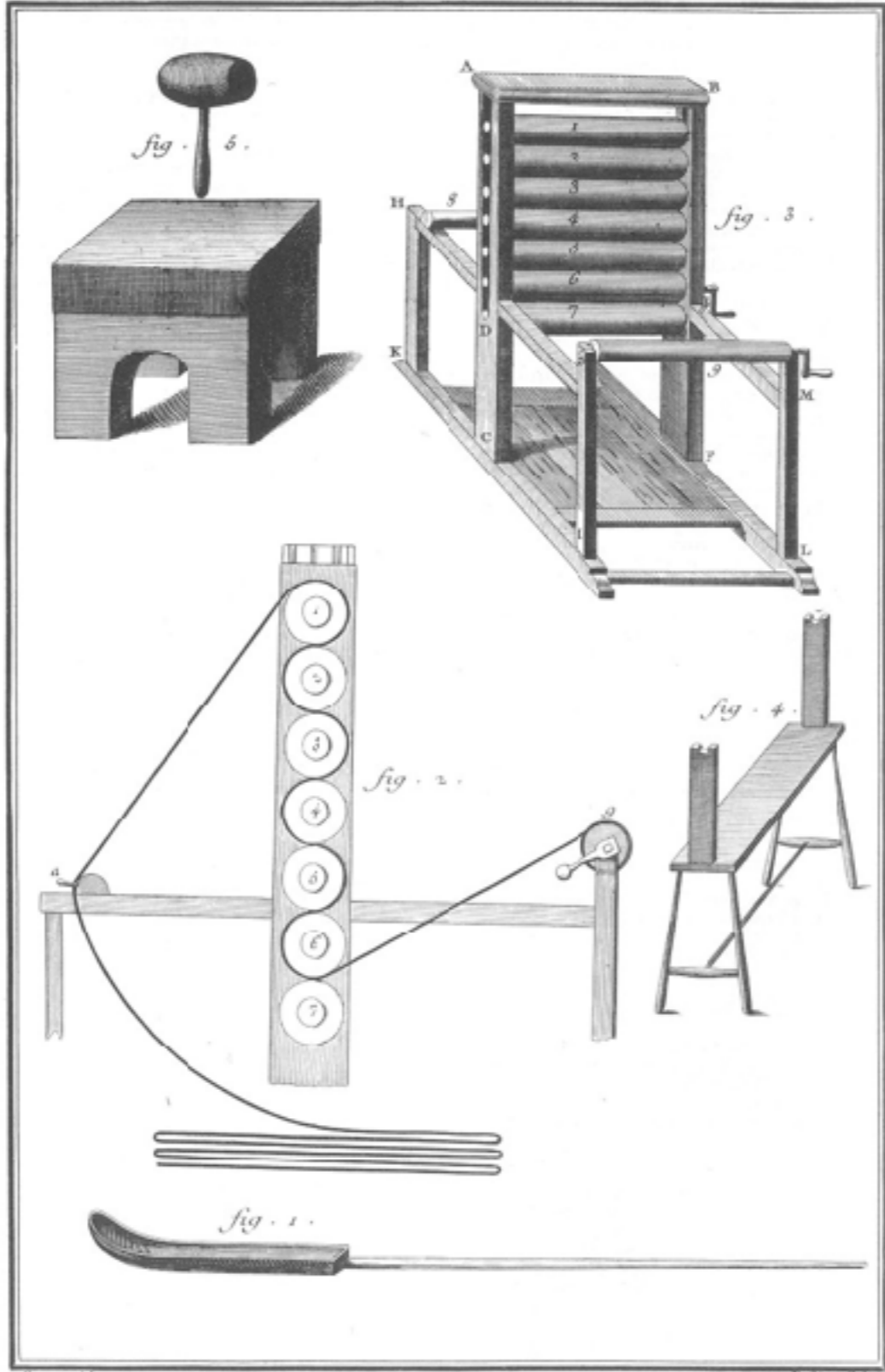

*Benard del.*

*Diderot fecit.*

*Blanchissage des Toiles.*

“Blanchissage des Toiles.”  
 The Encyclopedia of Diderot & d'Alembert 1763  
 (University of Michigan)

# Lace Production

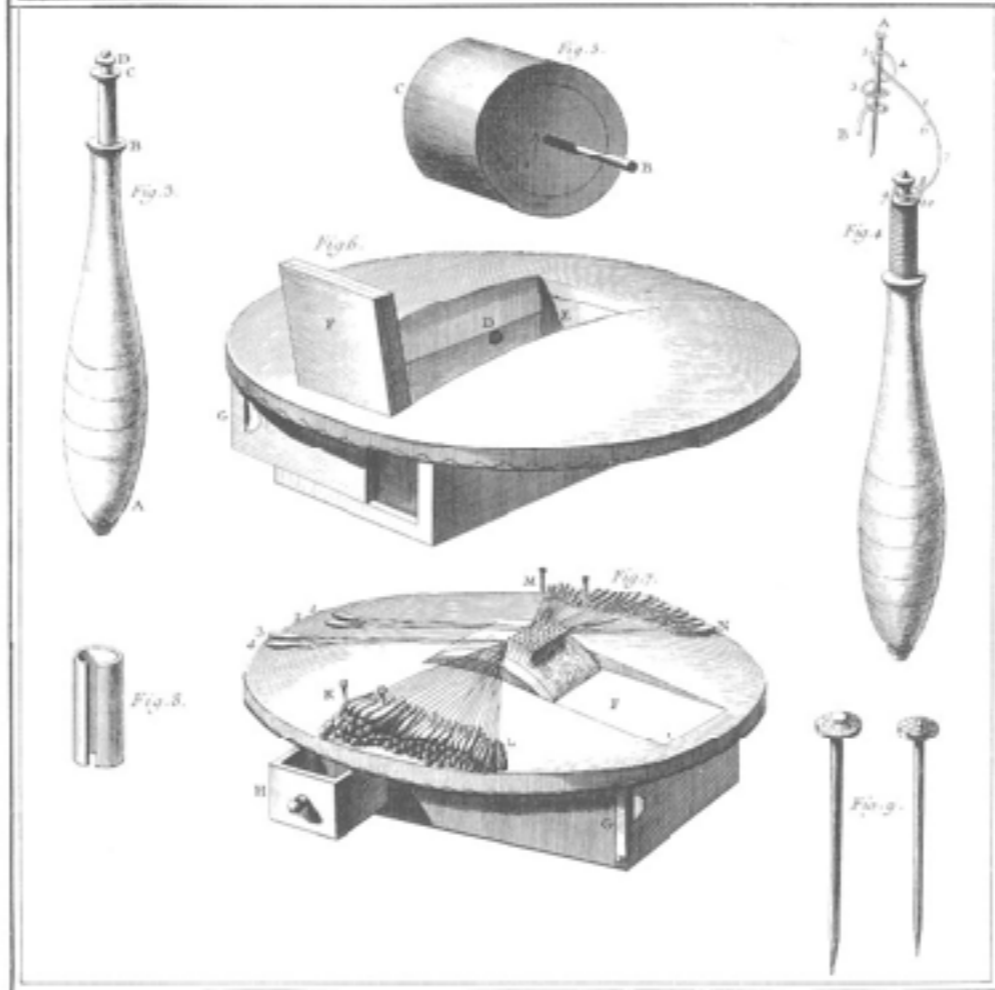

Goussier delinavit.

Hellot fecit.

*Dentelle.*

“Dentelle.”  
 The Encyclopedia of Diderot & d'Alembert 1763  
 (University of Michigan)

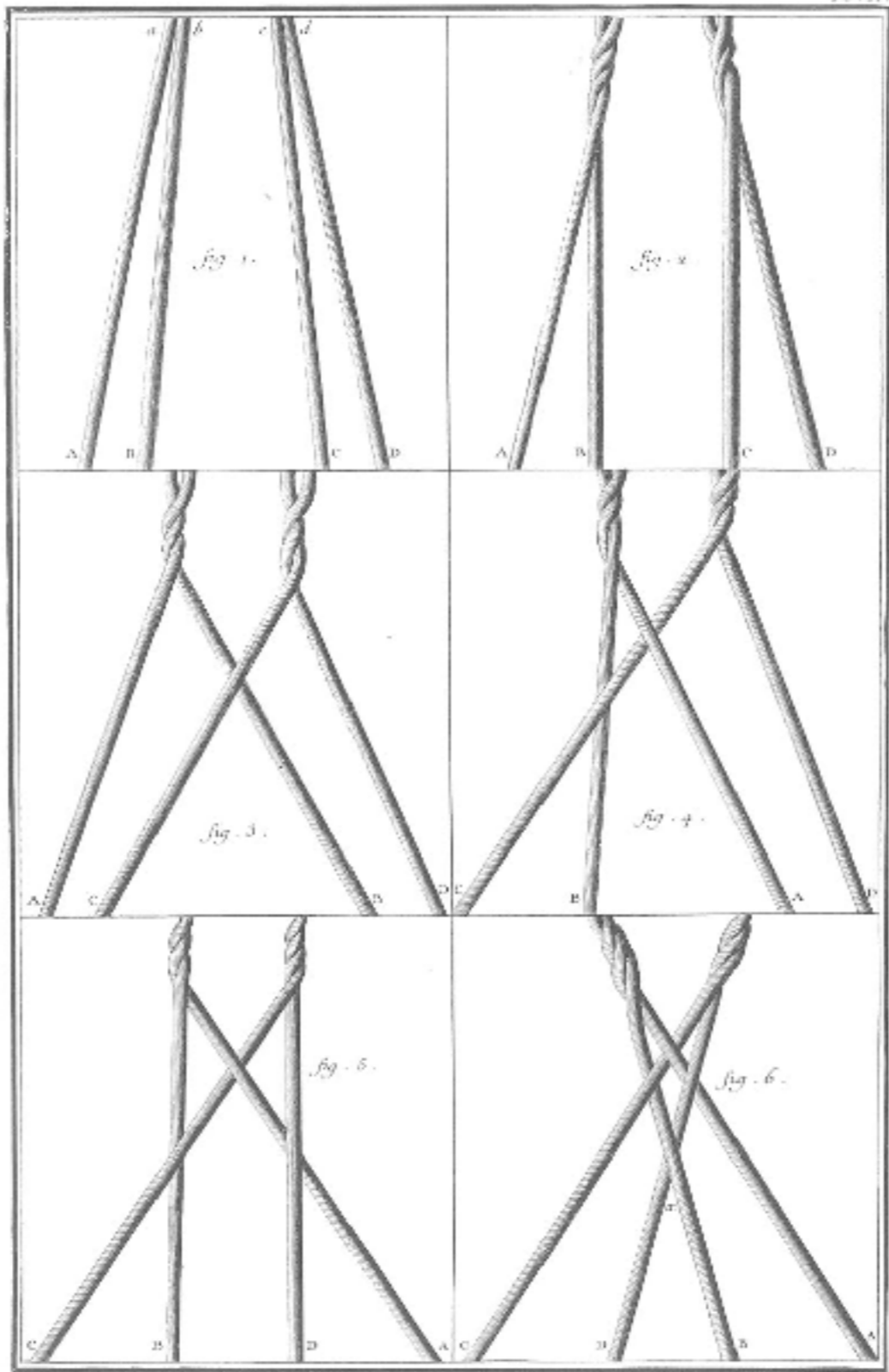

*Dentelle,*

“Dentelle.”  
 The Encyclopedia of Diderot & d'Alembert 1763  
 (University of Michigan)

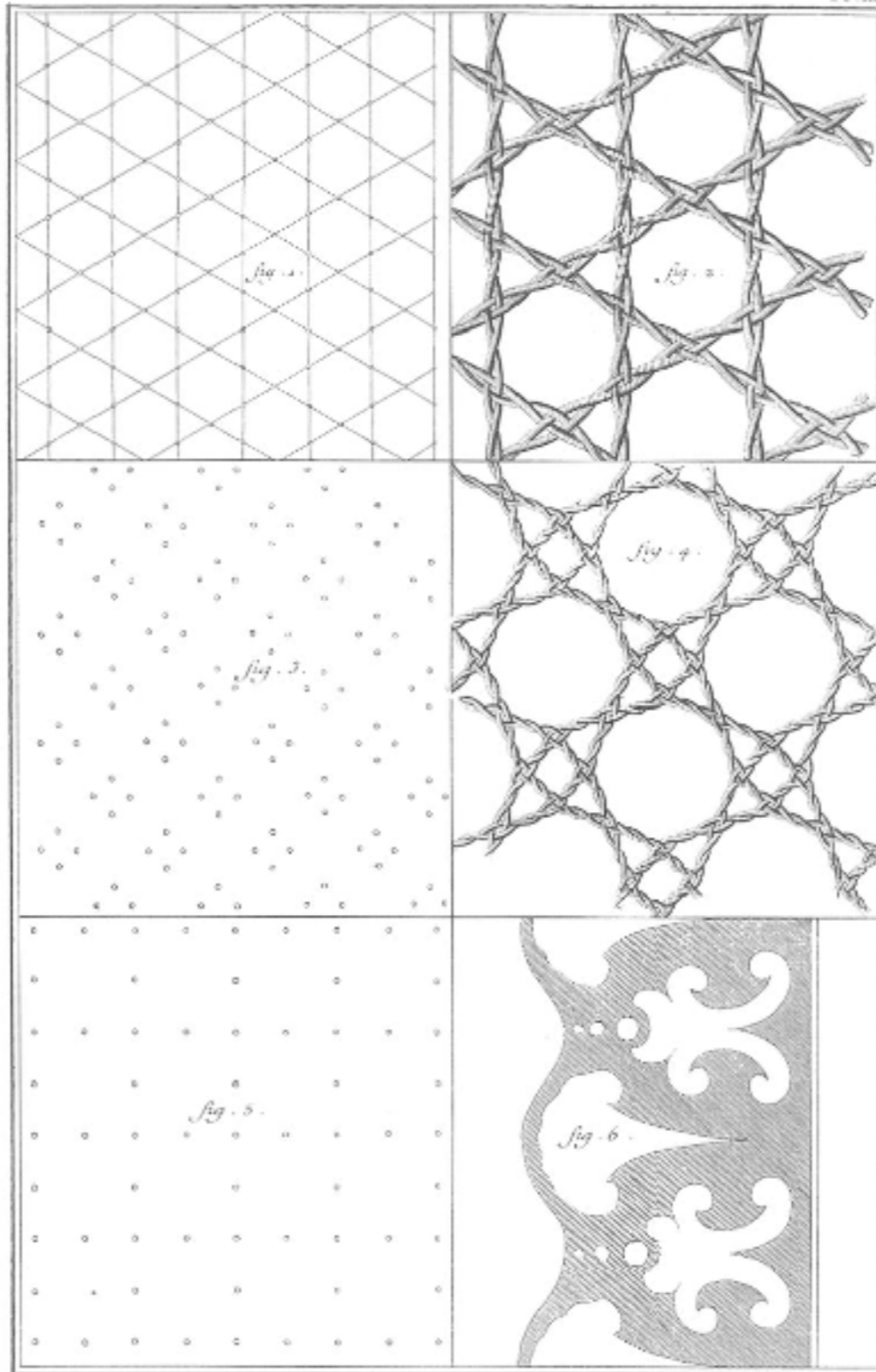

Dentelle,

“Dentelle.”  
The Encyclopedia of Diderot & d'Alembert 1763  
(University of Michigan)

# Acknowledgements

The material contained within these slideshows is presented for educational purposes only. The 18th Century Material Culture Resource Center does not personally own any of the items depicted herein and is indebted to the countless museums, libraries, and private collectors who willingly share their collections with the public through the internet. Every attempt has been made to credit these organizations and individuals for their contributions as best as possible.

If there is a question you have regarding a particular item featured within a presentation, please contact the 18th Century Material Culture Resource Center and we will try to answer your inquiry as best as possible. If for any reason you feel there is any item that should not be presented here, or if there is an error in any listing, or if you know the source for any item whose credit is unknown, please inform us and we will make sure your concern is addressed as soon as possible.

Thank you!

- The 18th Century Material Culture Resource Center